



- NEVER RUN R/C MODEL IN CROWDED AREA OR NEAR SMALL CHILDREN.
- PROTECT YOUR SYSTEM FROM MOISTURE.
- REMOVE BATTERY FROM R/C MODEL WHEN STORING.



TRANSMITTER FEATURES

Reverse Switch
Adjust when transmitter inputs are reversed for steering and throttle.

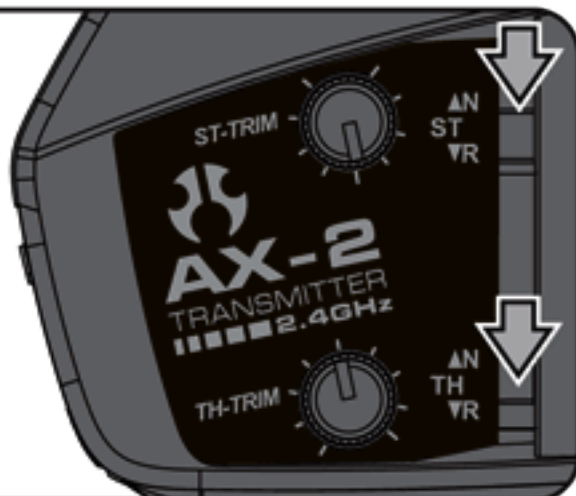

Antenna
Turn the antenna down and spin to front or back when not using.



ST.D/R
Steering Dual Rate



Used to adjust steering servo rate and range.

Battery Level Indicator



Blinking light indicates low batteries.

Steering Trim



Used to adjust steering center position.

Throttle Trim



Used to adjust throttle center position.

“Linking” Button
Located on the back.

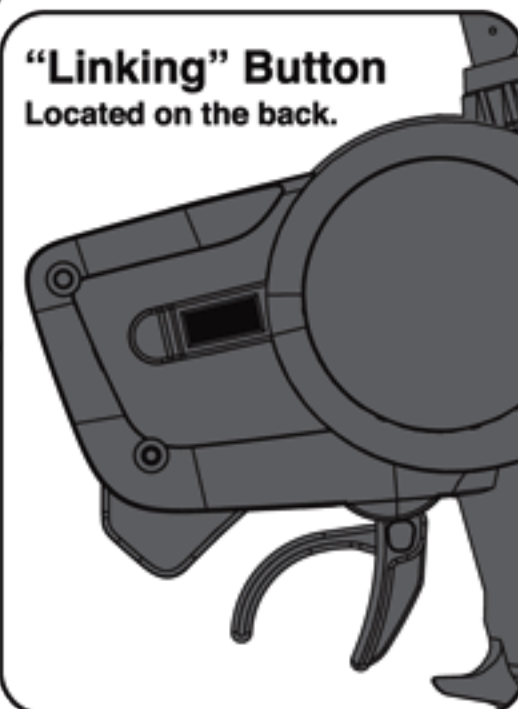

Power Switch

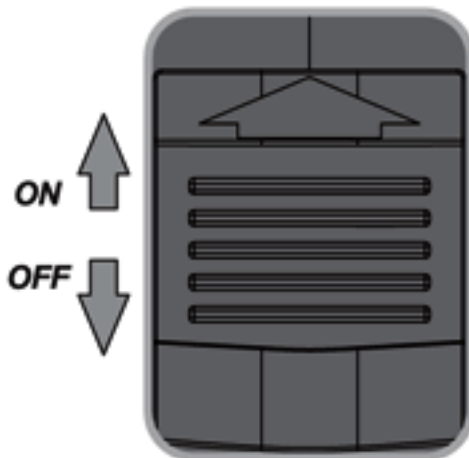

Steering Wheel

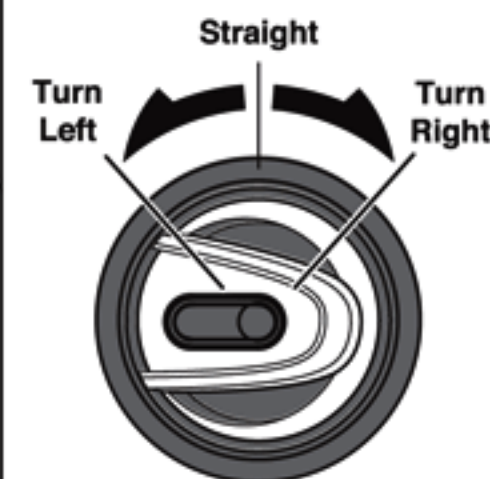

*** Charger plug-in.**
(Charger not included)

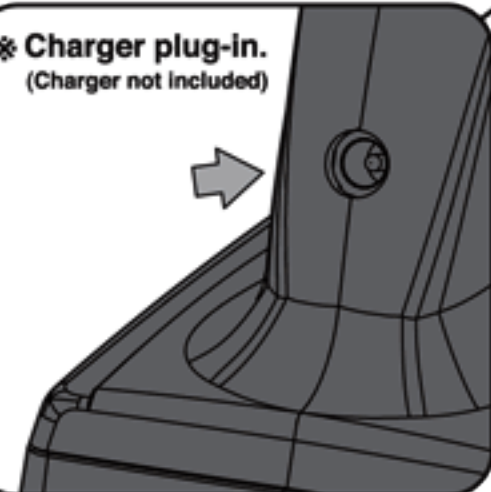

Battery Cover

* Please use rechargeable batteries and appropriate charger when you are recharging.

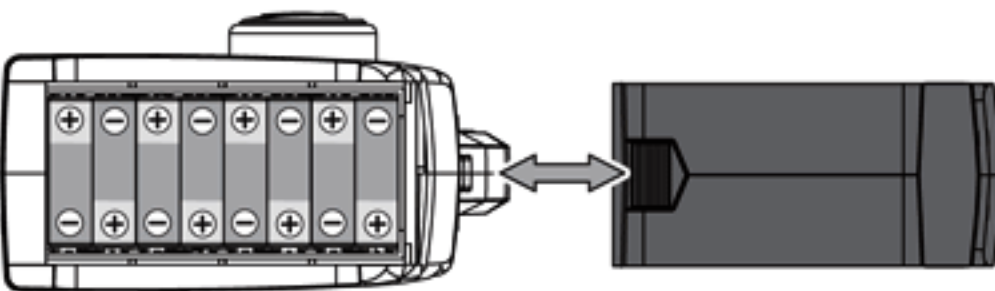

Throttle Trigger

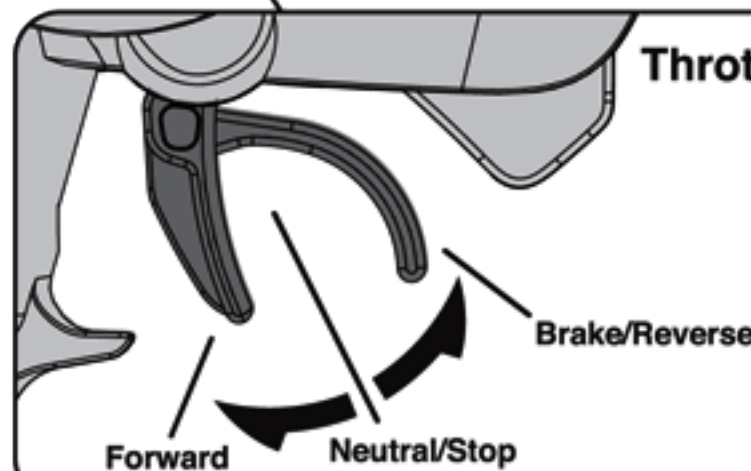

Transmitter Battery Installation

Open battery cover at the bottom of transmitter. Install batteries. Follow the direction of batteries designated in the inside of battery box.



8X AA Alkaline Batteries

ATTENTION

! Do not mix batteries of different ages or types. !

LINKING SETUP

When using for the first time, "linking" setup is required.

STEP 1

- Press and hold the button located on back of the transmitter.
- Turn on the transmitter.
- After 1 second, release the button and LED will begin blinking.

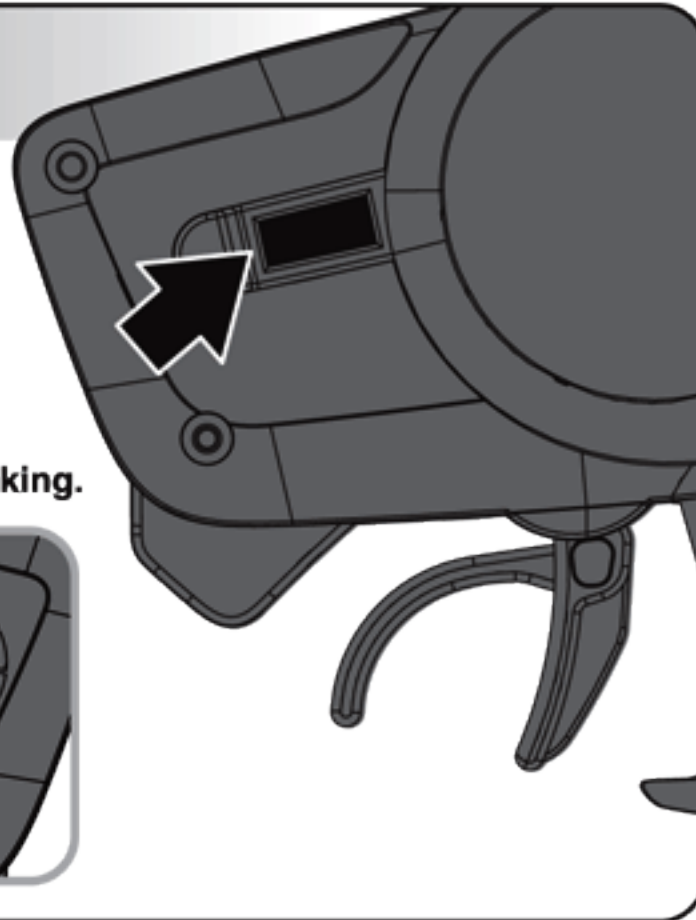
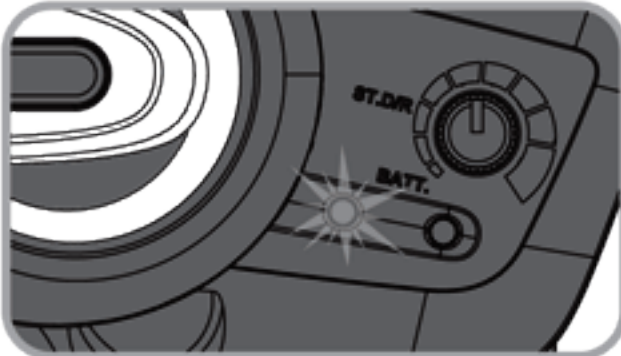

STEP 2

- Press and hold the switch on the receiver.
- Turn on the power to the receiver.
- After 1 second, release the switch and the red LED will be blinking.
- Turn off transmitter and power to receiver.
- Turn on transmitter and power to receiver to complete linking.



OPERATING PROCEDURES

1. Install transmitter batteries.
2. Turn on transmitter.
3. Turn on power to receiver.
4. Safely inspect R/C operation with transmitter. Adjust trims if needed.
5. Reverse procedures to turn off.

TROUBLESHOOTING

If Linking Fails:

- Someone nearby is linking at the same time. Complete linking at another time.
- Another nearby 2.4GHz device is being used. Stop using wireless LAN or Bluetooth devices.

SYSTEM SPECIFICATIONS

TRANSMITTER



Operating voltage	12V	Size	310x150x75mm
Output power	80mW	Weight	331.9g
Battery	AAx8		

RECEIVER



Channel number	2
Size	39x24x15mm
Weight	13.2g

FCC STATEMENT

1. This device complies with Part 15 of the FCC Rules. Operation is subject to the following two conditions:
 (1) This device may not cause harmful interference, and
 (2) This device must accept any interference received, including interference that may cause undesired operation.

2. Changes or modifications not expressly approved by the party responsible for compliance could void the user's authority to operate the equipment.