

# Digital Camber Gauge CTG-015

Instruction Manual v1.0

SKYRC

## INTRODUCTION

Congratulations on the purchase of SkyRC Digital Camber Gauge for 1/10 Touring Car!

With Bluetooth integrated, CTG-015 can measure the RC car's camber angle and toe angle and send data to your mobile phone.

Download the RC Gears app to get started to fine-tune your race wheels!

The accurate Digital Camber Gauge allows you to tweak your camber and camber gain settings, finding peace of mind that you are following a precise, replicable and trustworthy measurement tool.

On your setup wheels, in your race wheels, or next to your setup station, it will give you incredibly accurate readings on the camber angle of your wheels.

The fine-tuning and camber-adjusting allow you to achieve your perfect tire wear and traction point.

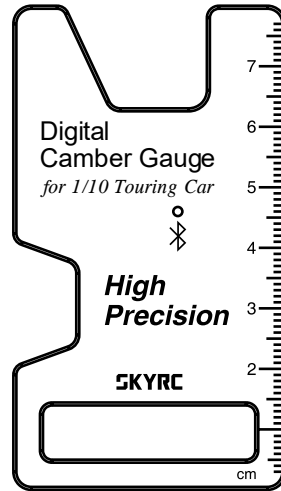

3. The corresponding module flashes blue during the process.

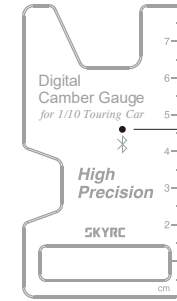
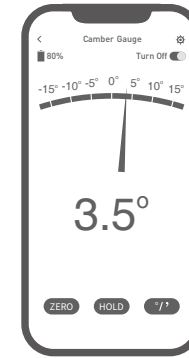

## CONNECTING

1. Long press to turn on. Enable Bluetooth on your smartphone and open the App;



\* Long press the switch to turn on.

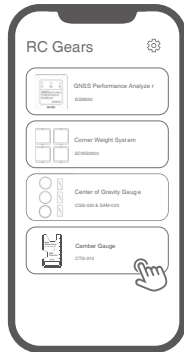

2. Search to connect;

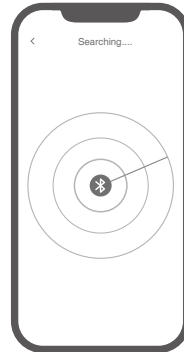

## MEASURE CAMBER

1 Place the racing wheel on a reference surface, and select the Zero button on the app.

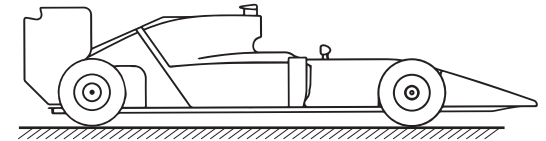

2 Hold the gauge against the wheel, and read the value through the app.

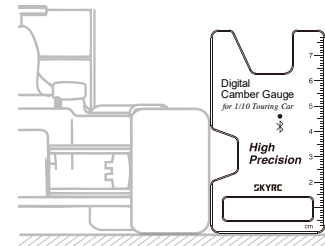

3 After measuring, you can tap the Hold button on the app for better reading.

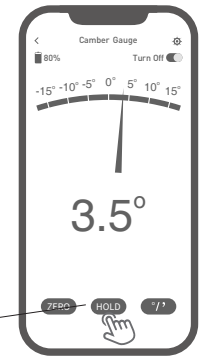

**Remark: More camber means more grip that the tire will touch the corner.**

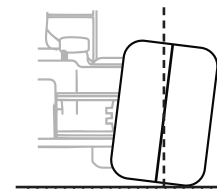

Positive Camber

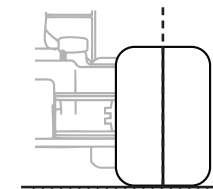

Zero Camber

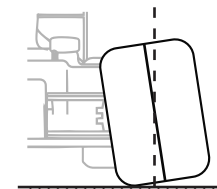

Negative Camber

## MEASURE TOE

- 1 Hold the car kit vertically on the setup station
- 2 Hold the gauge against the wheel, and read the value through the app, with peace of mind achieving a very accurate measurement of toe-in and toe-out.

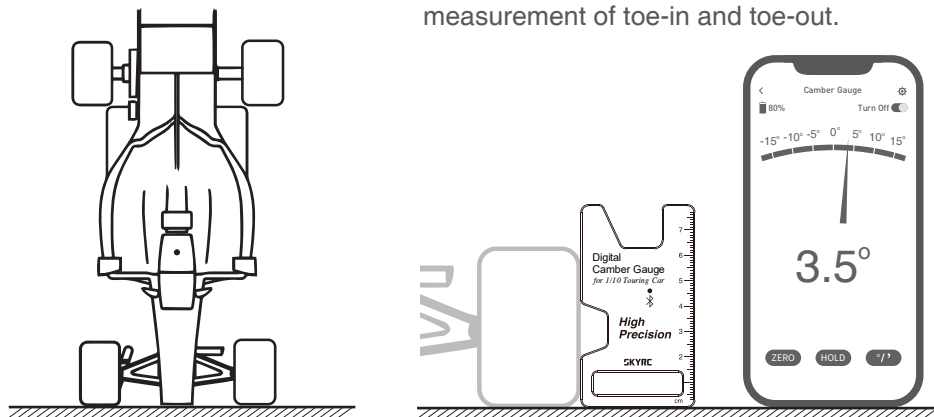

### Remark: More toe-out increases oversteer!

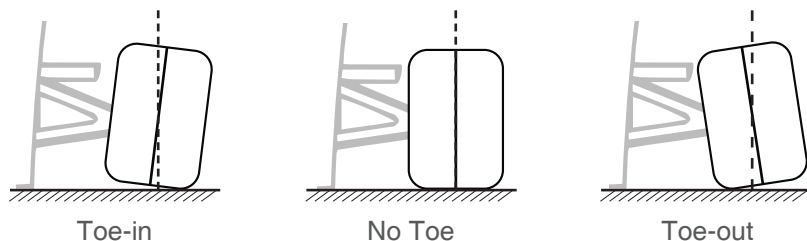

- This gauge's accuracy is astonishing. Tests have shown a tolerance of up to 0.2 degrees across a 3-degree range, which is commonly adopted for touring cars. Every single Camber and Toe Gauge is tested and calibrated before delivery.
- You can use this gauge on any angle setup station as the Zero function allows it to zero to any angled surface you are working on. Zero it on your setup station before use, and you will have accurate measurements throughout the day!

## SPECIFICATIONS

- Input Voltage: 5V
- Input Current: 200-300mA
- Interface: Type C
- Working Voltage: 3.4-4.2V
- Working Current: <10mA
- Size: 45x12x80mm
- Weight: 53g
- Low-voltage Protection: <3.4V (Flashes Red)
- Measuring Range:  $\pm 17.5^\circ$
- Measuring Accuracy:  $\pm 0.2^\circ$
- Working Temperature:  $0^\circ\text{C}-50^\circ\text{C}$
- Working Humidity: 5%-90% (None-condensation)
- Storage Temperature:  $-10^\circ\text{C}-50^\circ\text{C}$
- Storage Humidity: 1%-75% (None-condensation)

## WARRANTY AND SERVICE

We guarantee this product to be free of manufacturing and assembly defects for a period of one year from the time of purchase. The warranty only applies to material or operational defects, which are present at the time of purchase. During that period, we will repair or replace free of service charge for products deemed defective due to those causes.

This warranty is not valid for any damage or subsequent damage arising as a result of misuse, modification or as a result of failure to observe the procedures outlined in this manual.

### Note: The warranty service is valid in China only.

If you need warranty service overseas, please contact your dealer in the first instance, who is responsible for processing guarantee claims overseas. Due to high shipping cost, complicated custom clearance procedures to send back to China. Please understand SkyRC can't provide warranty service to overseas end user directly.

If you have any questions which are not mentioned in the manual, please feel free to send email to [support@skyrc.com](mailto:support@skyrc.com)

Manufactured by  
**SKYRC TECHNOLOGY CO., LTD.**

[www.skyrc.com](http://www.skyrc.com)

All specifications and figures are subject to change without notice.

7504-1648-01

© 2022.04