

Noble Pro

USER MANUAL

2.4GHz
AFHDS 3

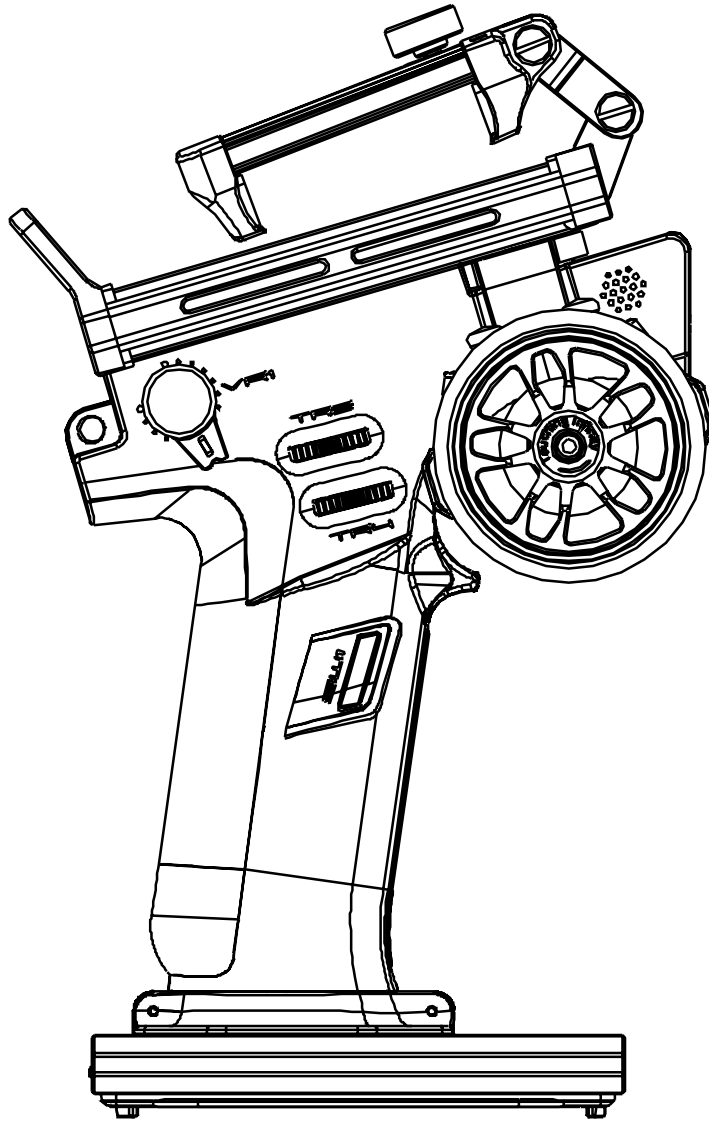

FLYSKY

Touching Infinity

Copyright ©2023 Flysky Technology Co., Ltd.

WARNING:
This product is only for 15 years old or above.



Official Accounts



Bilibili



Website



Facebook



Thank you for purchasing our products.

Read the manual carefully to ensure your personal safety as well as the safety of your equipment. If you encounter any problems during using, please refer to this manual first.

If the problem is still not resolved, please contact the local dealer directly or contact the customer service staff via the website below:
www.flysky-cn.com

Contents

1. Safety	1
1.1 Safety Symbols	1
1.2 Safety Guide.....	1
2.Product Introduction	2
2.1 System Features.....	2
2.2 Transmitter Overview.....	3
2.3 Receiver Overview	6
2.4 Status Indicator	6
3. Getting Started	7
3.1 Transmitter Battery Installation.....	7
4. Operation Instructions	8
4.1 Power On.....	8
4.2 Binding	8
4.3 Transmitter LED Indicator	9
4.4 Power Off	9
5. System Interface	10
6. Function Settings	11
6.1 REV	11
6.2 EPA.....	11
6.3 SUBTRIM	12
6.4 D/R	12
6.5 CURVE	12
6.6 TIMER	14
6.7 ASSIGN	15
6.8 AUX	17
6.9 MODEL.....	18
6.10 SENSOR	21
6.11 SPEED.....	32
6.12 MIXES	34
6.13 ABS	38
6.14 TH MID	40
6.15 NEUTRAL	40
6.16 IDLE UP	40
6.17 ENG CUT	41
6.18 CRUISE.....	41



6.19 FUEL	42
6.20 COND	42
6.21 LOGIC	43
6.22 BOAT	44
6.23 DISPLAY	44
6.24 SVC	45
6.25 BEGINNER.....	47
6.26 i-BUS2.....	47
6.27 HANDLE.....	52
6.28 HELP	54
7 RX SET.....	55
7.1 Bind Set.....	55
7.2 Steering Force	57
7.3 Gyro Gain	57
7.4 Steering ICS	57
7.5 Throttle ICS	58
7.6 Select Receiver.....	58
7.7 RX Interface Protocol.....	58
7.8 Failsafe	60
7.9 Servos Frequency	62
7.10 i-BUS2 Setup.....	63
7.11 i-BUS Setup.....	63
7.12 Config PWM Converter	64
7.13 RSSI Output Setup	65
7.14 RX Battery Monitor	65
7.15 Range Test	66
7.16 BVD Voltage Calibration	66
7.17 Low Signal Alarm	67
7.18 Update Receiver	67
8. SYSTEM.....	68
8.1 Theme	68
8.2 Wallpaper	68
8.3 Units.....	68
8.4 Backlight Adjustment.....	69
8.5 Sound	69
8.6 Vibration	70

8.7 LED	70
8.8 Auto Search Receiver	71
8.9 Quick Access	71
8.10 Mian Screen Lock Setup	71
8.11 Standby Timeout	72
8.12 Auto Power Off	72
8.13 Stick Calibration	72
8.14 Firmware Update	73
8.15 Factory Reset	73
8.16 About Noble Pro	73
9. Transmitter Specifications	74
9.1 Transmitter Specification (NB4)	74
9.2 Receiver Specification (FGr4B)	75
9.3 Receiver Specification (FGr8B)	75
10. Package Contents	76
11. Instructions	77
11.1 Brake Pad Replacement and Angle Adjustment	77
11.2 Installation of Mobile Phone Holder	79
11.3 Disassembly of Mobile Phone Holder	80
11.4 Wireless Charging Function and Precautions	82
11.5 Replacing VR1 Knob as a Three-position Switch	83
11.6 Replacing the 3-position Switch as VR1 Knob	84
12. Certification	85
12.1 DoC Declaration	85
12.2 CE Warning	85
12.3 Environmentally friendly disposal	85
12.4 FCC Statement	86

1. Safety

1.1 Safety Symbols

Pay close attention to the following symbols and their meanings. Failure to follow these warnings could cause damage, injury or death.

 Danger	• Not following these instructions may lead to serious injuries or death.
 Warning	• Not following these instructions may lead to major injuries.
 Attention	• Not following these instructions may lead to minor injuries.

1.2 Safety Guide



Prohibited



Mandatory



- **Do not use the product at night or in bad weather like rain or thunderstorm. It can cause erratic operation or loss of control.**
- **Do not use the product when visibility is limited.**
- **Do not use the product on rain or snow days. Any exposure to moisture (water or snow) may cause erratic operation or loss of control.**
- **Interference may cause loss of control. To ensure the safety of you and others, do not operate in the following places:**
 - Near any site where other radio control activity may occur
 - Near power lines or communication broadcasting antennas
 - Near people or roads
 - On any body of water when passenger boats are present
- **Do not use this product when you are tired, uncomfortable, or under the influence of alcohol or drugs. Doing so may cause serious injury to yourself or others.**
- **The 2.4GHz radio band is limited to line of sight. Always keep your model in sight as a large object can block the RF signal and lead to loss of control.**
- **Never grip the transmitter antenna during operation. It significantly degrades signal quality and strength and may cause loss of control.**
- **Do not touch any part of the model that may generate heat during operation, or immediately after use. The engine, motor or speed control, may be very hot and can cause serious burns.**



- **Misuse of this product may lead to serious injury or death. To ensure the safety of you and your equipment, read this manual and follow the instructions.**
- **Make sure the product is properly installed in your model. Failure to do so may result in serious injury.**
- **Make sure to disconnect the receiver battery before turning off the transmitter. Failure to do so may lead to unintended operation and cause an accident.**
- **Ensure that all motors operate in the correct direction. If not, adjust the direction first.**
- **Make sure the model flies within a certain distance. Otherwise, it would cause loss of control.**



微信公众号



Bilibili



Website



Facebook

2. Product Introduction

This product uses 2.4GHz, third generation, automatic frequency hopping digital system, consisting of a Noble Pro (NB4 Pro for short) transmitter, FGr8B receiver, and FGr4B receiver. It supports output in 18 channels. In addition, the product implements extreme-speed output on 2 channels. A cell phone holder with Noble Pro is more convenient for users to perform monitoring in real time. It is also compatible with model cars, boats, and etc. It supports a USB simulator function (enabled by default).

2.1 System Features

AFHDS3 (third-generation automatic frequency hopping digital system) is a newly developed digital wireless system. It is compatible with single antenna bidirectional real-time data packet transmission and data stream transmission. With the advantages that come with the WS2A wireless system and the new 2.4GHz chip, the system can dynamically set: number of channels, channel resolution, range, anti-interference requirements and latency to meet the needs of different users.

Single Antenna Bidirectional Real-time Data Transmission	The system supports one-way and two-way connections. When the transmitter is working in oneway transmission way, the receiver can receive data from the transmitter. When the transmitter is working in two-way transmission way. The receiver can receive data from the transmitter and the transmitter can also receive data from the receiver, as well as the information cross from the temperature and speed sensor modules. This gives better control over the models and obtains information on its current status, so as to make model control more secure.
Uncorrected Data Transmission	The independent uncorrected data transmission module is built into RF system; it can send many different types of data including flight control data.
Intelligent RF configuration	Depending on hardware, certification, the amount of data to be transmitted, anti-interference, latency and distance requirements, the system intelligently adapts the corresponding RF configuration to meet the requirements of the user.
Multi-channel Frequency Hopping	This systems bandwidth ranges from 2.402GHz ISM to 2.480GHz. This band is divided in 140 channels. Each transmitter hops between 16 channels (32 for Japanese and Korean versions) in order to reduce interference from other transmitters.
Unique ID Recognition System	Each transmitter and receiver has it's own unique ID. Once the transmitter and receiver have been bound, the ID will be saved. When the syetem is working,if the IDs are matched, the connection will be connect, otherwise, there is no connection between transmitter and receiver. This unique ID recognition syetem resists the interference so as to make the system stabler and more reliable.
Low Power Consumption	The system is built using highly sensitive low power consumption components, maintaining high receiver sensitivity, while consuming as little as one tenth the power of a standard FM system, dramatically extending battery life.



2.2 Transmitter Overview

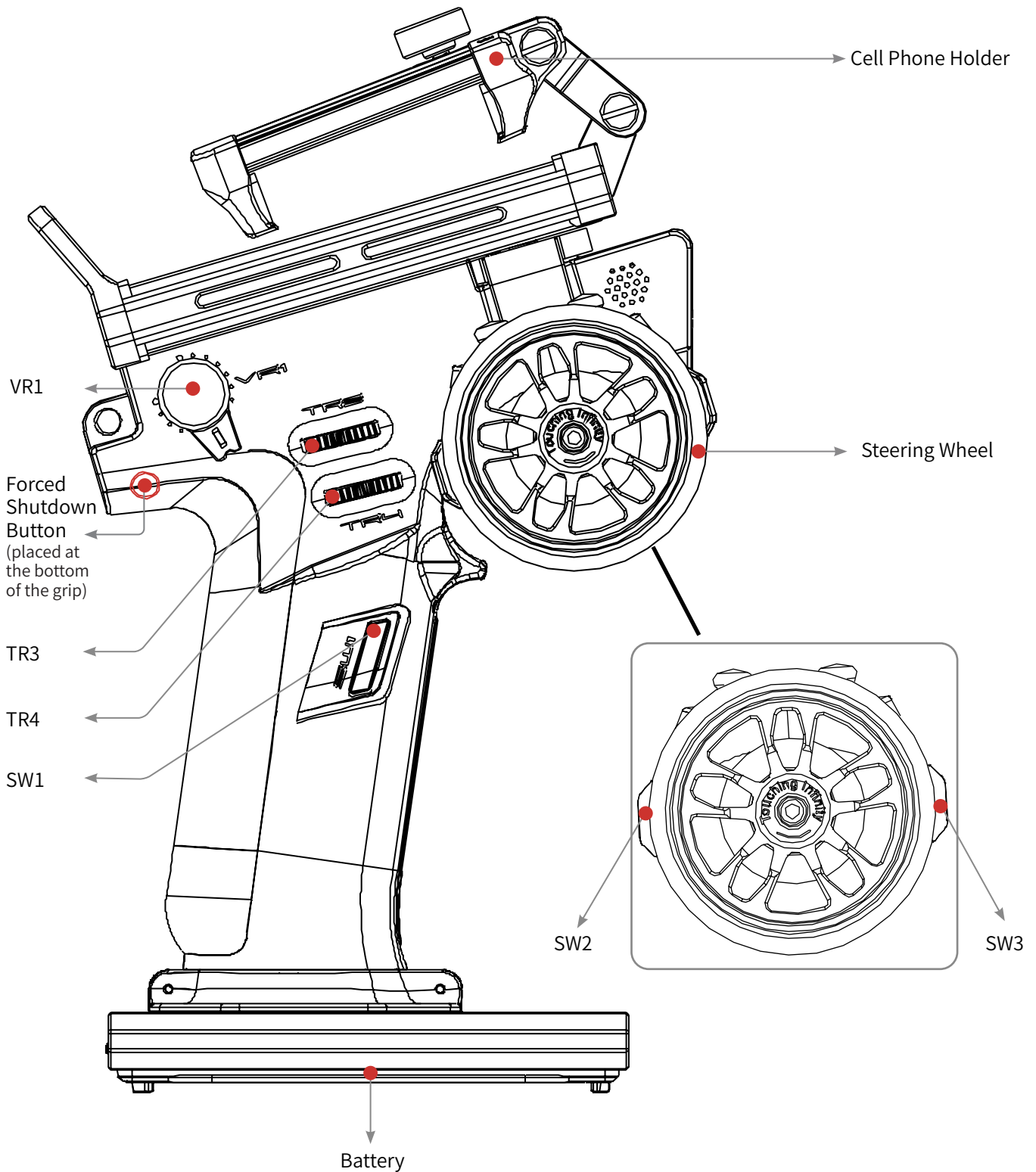

Note: If you can't shut down the transmitter properly, please shut down the transmitter by pressing the force shutdown button on the transmitter. (Operation: Pull apart the hand glue placed at the top of transmitter's grip or take off the whole handle glue. Use a relatively slender tool, insert the tool into the round hole on the right side of the grip(direction as shown in the figure above), and press the forced switch button in the round hole. After pressing the button, the transmitter will be shut down immediately.



微信公众号



Bilibili



Website



Facebook

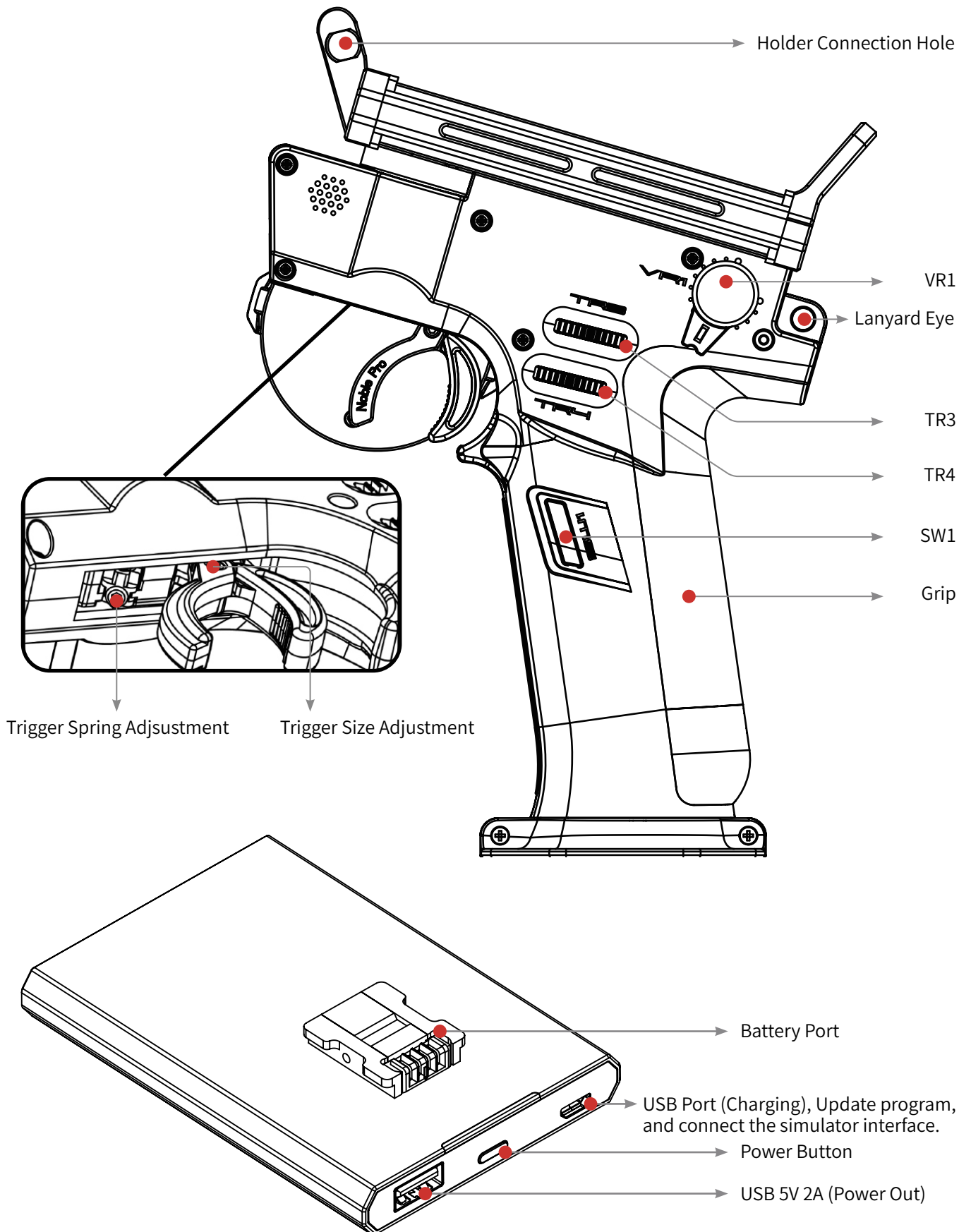

Base power button: Press for a short time to charge the battery at the transmitter handle and to charge external devices. Press for 2 seconds to turn off the output of the power supply.



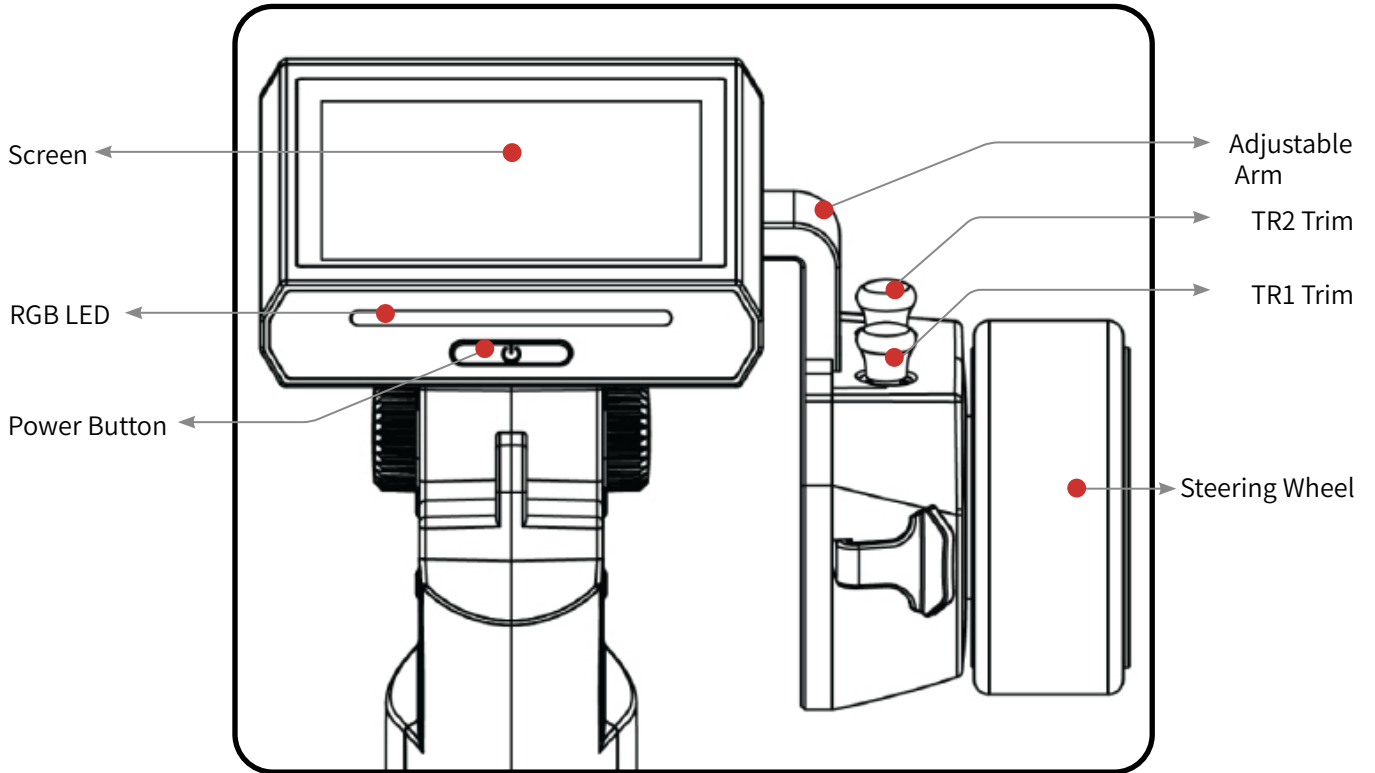

Adjust the length of the cell phone holder

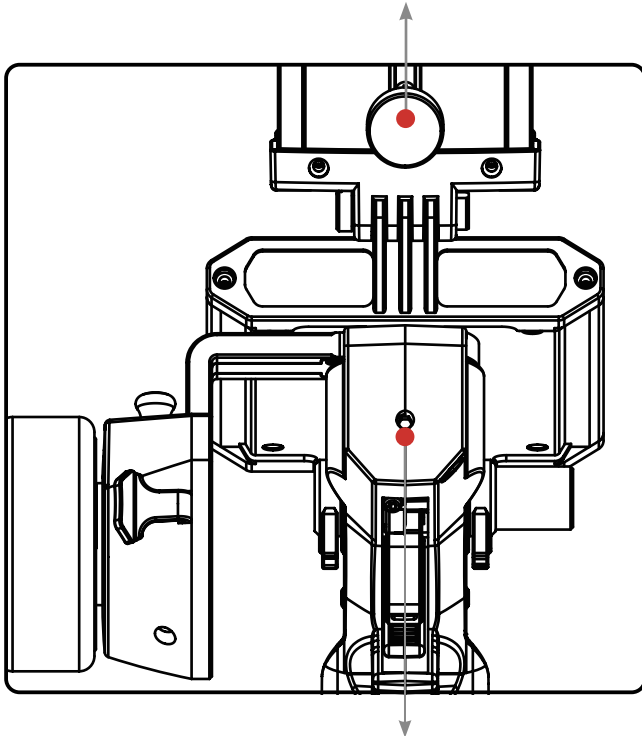

Steering Wheel Tension Adjustment Screw

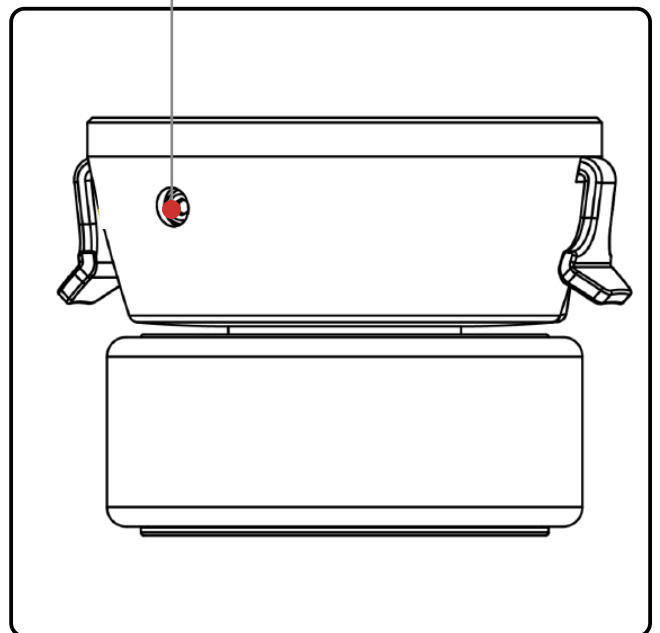

Trigger Position Adjustment Screw



微信公众号



Bilibili



Website



Facebook

2.3 Receiver Overview

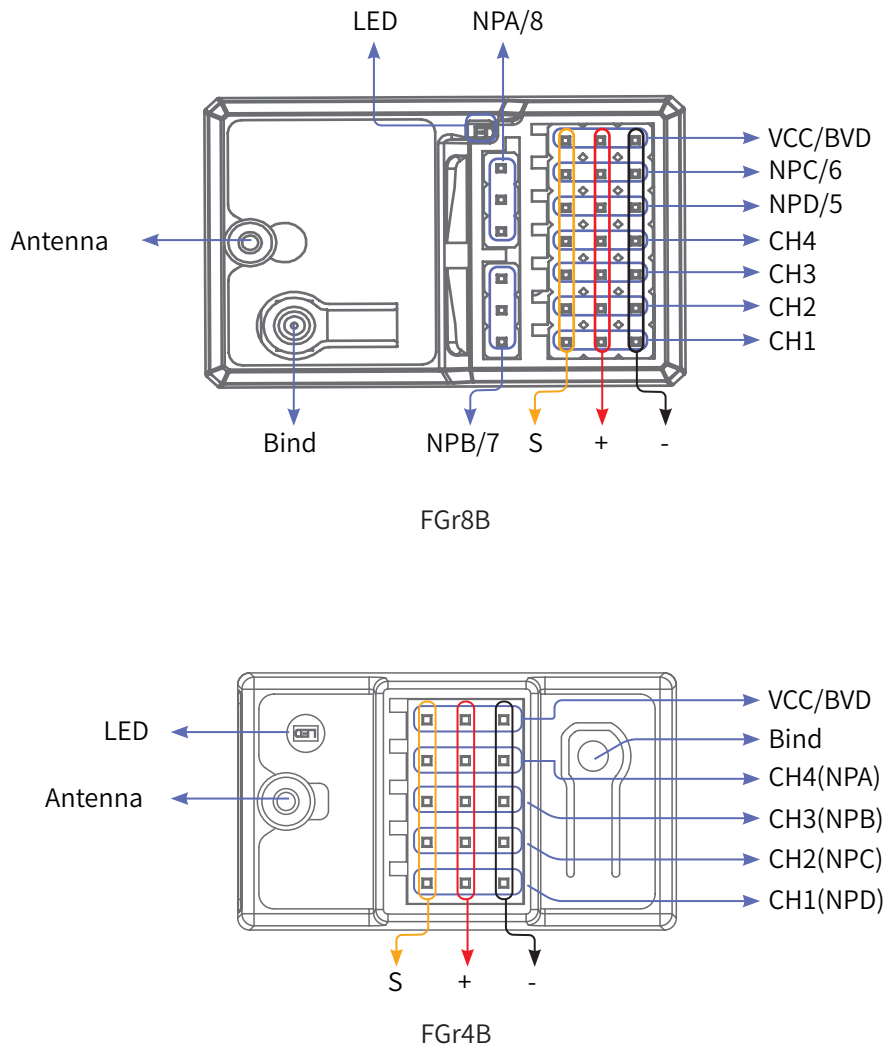

For best signal quality, it is recommended to keep the receiver antenna up and away from metal when installing the FGr8B or FGr4B receivers.

2.4 Status Indicator

The status indicator is used to indicate the power and working status of the receiver.







- Off: The power is not connected.
- Lit in red: The receiver is on and working.
- Flashing quickly: The receiver is binding.
- Flashing slowly: The bound transmitter is off or signal is lost.
- Three-flash-one-off: The receiver is in firmware upgrade state.



3. Getting Started

Before operation, install the battery and connect the system as instructed below.

3.1 Transmitter Battery Installation

 Danger	• Only use included batteries .
 Danger	• Do not open, disassemble, or attempt to repair the battery.
 Danger	• Do not crush/puncture the battery, or short the external contacts.
 Danger	• Do not expose to excessive heat or liquids.
 Danger	• Do not drop the battery or expose to strong shocks or vibrations.
 Danger	• Always store the battery in a cool, dry place.
 Danger	• Do not use the battery if damaged.

The Noble Pro has 2 batteries, one located in the handle and one in the removeable base.

To attach the base:

1. Line up the base so that the transmitter handle has a slight over hang on the back.
2. Carefully insert the base contacts into the hole in the bottom of the handle.
3. Hold the handle firmly and pull the battery backwards. When it is secure you should hear a click.

Steps to disassemble the base:

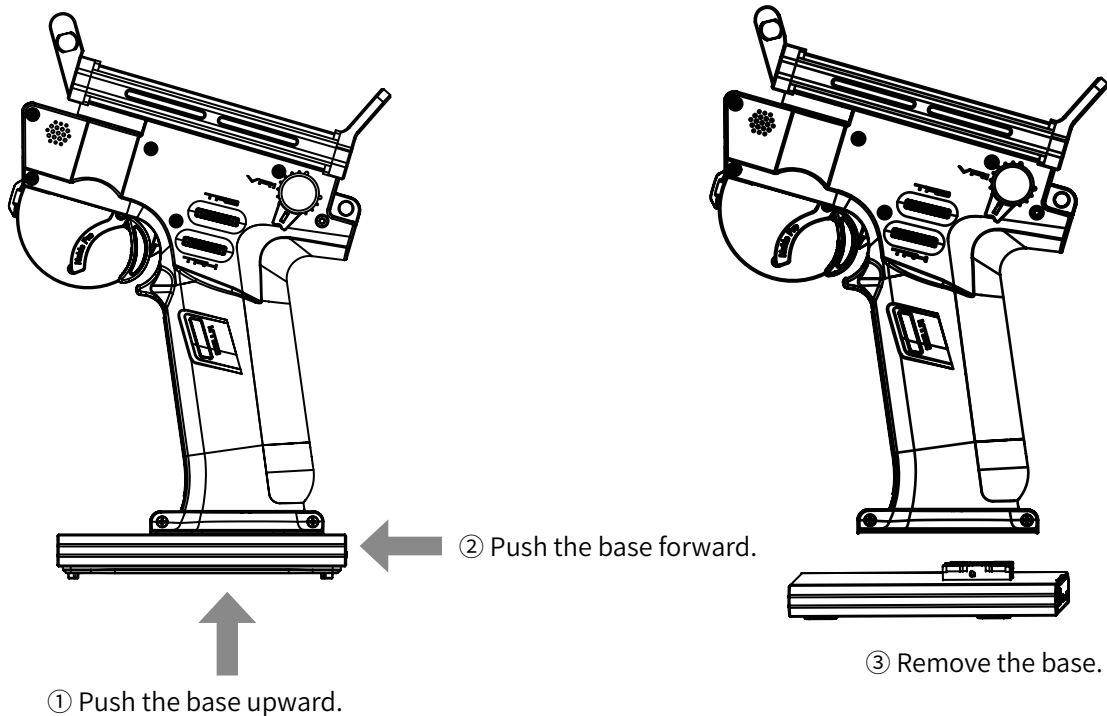

微信公众号



Bilibili



Website



Facebook



4. Operation Instructions

After setting up, follow the instructions below to operate the system.

4.1 Power On

Follow the steps below to turn on the transmitter:



1. Make sure that:
 - The battery is fully charged and installed correctly.
 - The receiver is installed correctly and powered on.
2. Hold the power button until the screen turns on.

 Note	• Operate with caution in order to avoid damage or injury.
 Note	• Make sure that the throttle is at its lowest position and the switches are set to their up position.

4.2 Binding

The transmitter and receiver have been pre-bound before delivery.

If you are using another transmitter or receiver, follow the steps below to bind the transmitter and receiver:

1. Press the Bind button on the receiver for seconds, and then connect the power cord to any interface on the receiver. At this time, the receiver will flash quickly.
 - Please make sure your transmitter is not connected to other receivers before binding.
2. Turn on the transmitter, click  and enter [RX SET], and select [Bind Set] on the menu.
3. Click [Enhanced RX]. Under the [Start Channel] menu, click  on the right of the corresponding channel as needed, and click  to return to the previous interface.
4. Click [Start Bind]:
 - AFHDS3 2 Way: If binding is successful the status indicator will remain solid and the transmitter will exit bind mode automatically.
 - AFHDS3 1 Way: If binding is successful the status indicator will flash slowly, however bind mode on the transmitter must be exited manually by touching the back icon.
5. Once binding is complete, remove the power and bind cable from the receiver.
6. Check to make sure everything functions as expected. If not repeat the steps above.
 - This binding procedure only applies to the Noble Pro transmitter and FGr8B/FGr4B receivers. Different receivers have different binding procedures. Please refer to our official website for more information and relevant user manuals.



4.3 Transmitter LED Indicator

This LED has five colors, red, green, blue, yellow, white and off which can be set according to user preference. You can also check the battery indicator. The transmitter LED can also be used as a power indicator.

To change the LED color see the LED Strip section of this user manual.

4.4 Power Off

Follow the steps below to turn off the system:

1. Disconnect the receiver power first.
2. Press and hold the transmitter power button until the screen turns off.



Danger

- Make sure to disconnect the receiver power before turning off the transmitter. Failure to do so may lead to damage or serious injury.



微信公众号



Bilibili



Website



Facebook

5. System Interface

The main interface mainly displays information related to the model, such as transmitter voltage information, function status and so on.

The display on the main interface can be customized as required, including the states and data of the main interface. Up to 8 states and data can be displayed.

Main interface left slide: Channel display; right slide: Failsafe; upward slide: Timer; downward slide: System settings. If you need to change settings, refer to [8.9 Quick Access].

Model Name 1: Flysky 01 RX TX

Sensors
0 to -40 dBm: The communication quality is best. -40 dBm to -85 dBm: The communication quality is good. Less than -85 dBm: Indicates that there is an obstacle between the transmitter and receiver or the distance is far. Shorten the control distance to avoid losing control.

Dashboard Display
Show the real time status of the function. Tap the dashboard area to enter the setting interface and set the related functions to be displayed as required.

Steering Trim

Display Custom of Main Interface
Tap this area, and then click Select Home Screen Display options to enter settings Screen, select related functions to be displayed as required.

Bottom Bar

Menu Icon
Tap and hold the icon for 2 seconds to lock or unlock the screen.

Function Status Bar

Dashboard Display
Tap the dashboard area to enter the setting interface and set the related functions to be displayed as required.

Throttle Trim

Display Custom of Main Interface
When the sensor values are displayed, you can set the corresponding values of the dashboard pointer range by the maximum and minimum values.

The bottom bar is hidden.
Swipe right on the main screen to enter the main menu. For details about the Settings on the bottom bar, see [8.9 Quick Access].

RX's Battery Volume

TX's Battery Volume

TX Voltage 4.07V

RX Voltage 4.52V

RSSI -38dBm

TX Voltage 3.98V

Steering 0%

Throttle 0%

CH3 0%

CH4 -100%

CH5 0%

CH6 0%

ST Rate: 100%

F Rate: 100%

B Rate: 100%

CH5 0%

CH6 0%

F Rate: 100%

Function Status Bar

The function status bar displays the status of various functions. If the function is a darker color then it is active, if it is slightly see through then it is inactive.

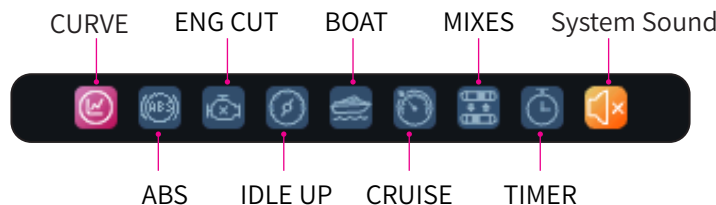

It indicates that the function is currently disabled and all settings are invalid.



it indicates that the function is currently enabled and all settings have taken effect.



Reset Icon
Used to reset the setting parameter.



微信公众号



Bilibili



Website



Facebook

6. Function Settings

This section introduces details functions and their use.

Notes:

1. The default ex-factory state of this transmitter allows the user to set the functions under CH1-CH4, follow the steps for specific function settings for other channels.
2. Some functions are disabled by default, and you may need to tap  and enable the function for the setting to take effect.
3. The function menus may vary with the receiver protocols. The actual product menu shall prevail.

6.1 REV

The REV(Reverse function) is used to correct a servo or motor's direction in relation to the systems controls. For example, if a steering servo is mounted upside down in order to fit inside a model, when the system's steering wheel is turned, the servo will move in the opposite direction. To fix this, all we need to do is reverse CH1.

The Condition function can be used for REV function, and you can set the REV function for both condition 1 and condition 2 respectively. Namely, you can set different channel directions in different conditions.

Setup:

1. Touch the box next to the channels name. If the channel is in normal mode the box will display "NOR", if it is reversed it will display "REV".
2. Test to make sure everything is working as expected.



6.2 EPA

EPA(End Point Adjust) are the limits of the channels range of movement. There are two endpoints, a low endpoint and a high endpoint.

Setup:

1. Touch a low or high endpoint box on a channel or move the control to the diection you wish to limit. The selected endpoint will be highlighted in green.
2. Use the + and - keys to change the end point position. The maximum is 120% and minimum is 0%.
3. Test to make sure everything is working as expected.

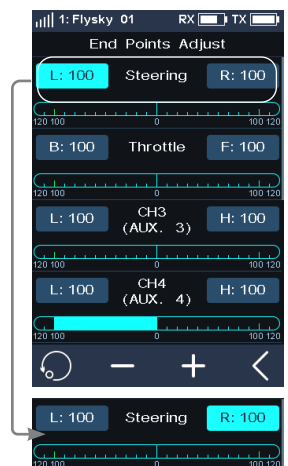

微信公众号



Bilibili



Website



Facebook

6.3 SUBTRIM

SUBTRIM can be used to adjust the error of the structure by changing the channel neutral position.

For example, if a car's wheels are slightly out of alignment, even when the transmitter steering wheel is not being touched, subtrim can be used to correct the alignment.

Setup:

1. Touch the box next to the channel name to select it. When selected the box will be highlighted in green.
2. Use the + and - keys to change subtrim position.
3. Test to make sure everything is working as expected.

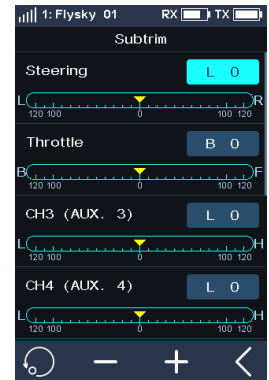

6.4 D/R This function is available for version 1.0.3 or later.

To set the output rates of channel 1 and channel 2, namely, the ST Rate, the Forward Rate, and the Brake Rate.

The value ranges from 0 to 100%. The default value is 100%. The steering bar and the throttle progress bar at the bottom of the interface display the real-time channel status of this two channels respectively.

The Condition function can be used for D/R function, and you can set the rate parameter for condition 1 and condition 2 respectively.

The rates can also be adjusted by VR/TR controls. Please refer to [Assign] function for setting.

Setup:

1. Touch an option you want to set (When the option is selected, it will be highlighted).
2. Use the + and - icons to raise or lower the percentage as needed. The rate value increases in case of clicking "+", and decreases by clicking "-".
3. Test to make sure everything is working as expected.

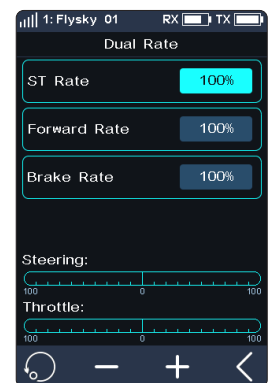

6.5 CURVE This function is available for version 1.0.3 or later.

It is used to set the data change rate of channel 1 and channel 2, that is, the Steering Curve, the Forward Curve, and the Brake Curve.

This function is enabled by default. Click to disable this function. When this function is disabled, the icon will change to . The function can also be turned on/off by an assigned control via [ASSIGN].

The Condition function can be used for D/R function, and you can set the curve parameter for condition 1 and condition 2 respectively.

ST Curve

To set the data change rate of channel 1.

[Type]: Set the curve change form. You can set it to exponential [EXP] (smooth curve) or ARC (bend position adjustable). By default, it is EXP.

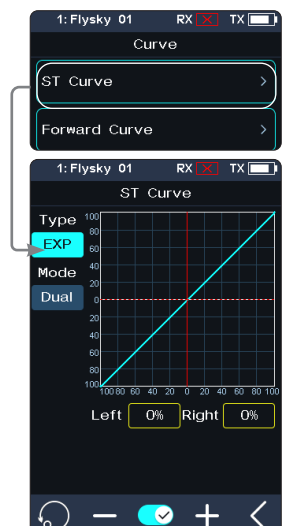

[Mode]: Set the adjustment mode of the curve, which can be set as "Dual" (synchronous adjustment of left and right sides) or "Single" (independent adjustment of left and right sides).

[Left]: Left rate, which can be adjusted when the mode is set to Single. It is used to independently adjust the left curve of channel 1.

[Right]: Right rate, which can be adjusted when the mode is set to Single. It is used to independently adjust the right curve of channel 1.

[Point]: It can be adjusted when the type is set to ARC, and used to set the turning point position of the polyline.

Setup:

1. Touch [ST Curve] to enter.
2. Touch [Type] or [Mode] to set the corresponding type and mode.
3. Use the + and - icons to raise or lower the percentage as needed.
4. Test to make sure everything is working as expected.

The rates can also be adjusted by VR/TR controls. Please refer to [Assign] function for setting.



Forward Curve

To set the data change rate of channel 2.

[Type]: Set the curve change form. You can set it to exponential [EXP] (smooth curve), ARC (bend position adjustable) or multi-fold CRV (fixed fold position, 9 points in total). By default, it is EXP.

[Point]: It can be adjusted when the type is set to ARC, and used to set the turning point position of the polyline.

[Rate]: To set rate for the curve.

Refer to the previous description [ST Curve] for the function setting steps.

The rates can also be adjusted by VR/TR controls. Please refer to [Assign] function for setting.

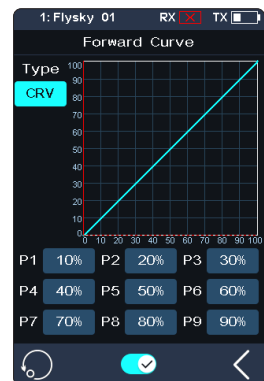

Brake Curve

To set the data change rate of channel 2 in case of brake or backward.

Refer to the previous description [ST Curve] for the function setting steps and parameters descriptions.



微信公众号



Bilibili



Website



Facebook

6.6 TIMER

This function can set with a variety of timers, to generally calculate the total model run time, competition specific time spent, or transmitter run time, etc.

The function can be enabled, disabled or cycle-counted by an assigned control. Please refer to [Assign] function.

The timer features three different modes of timer:

Up Timer

Start the clock from zero.

Click [Up Timer], then click [Start] to start the timer. Click [Stop] to stop the timer. Click [Reset] to reset the single timer function to its default value.

Down Timer

Countdown from the set time, the shortest time is 1 second. The system will send out a reminder when it reaches a minute sharp. When the countdown is less than 1 minute, the system will give voice prompt in 30 seconds, 20 seconds, 15 seconds. And when the countdown time left only 10 seconds, the system will send a voice prompt every second. When the timer reaches 0, the system will send a voice to prompt that the timer time is up, and start up timer.

Click [Down Timer], then click . Then click the minutes or seconds display interface, by clicking "+" or "-" to change the duration. Press and hold the + or - icon to accelerate the adjustment. The maximum duration is 99 minutes and 59 seconds.

Lap Timer

Record the length of each lap.

Once triggered the on icon will become the lap icon. After clicking Lap, the system starts the next lap timer immediately. The timer voice prompts the number of the last lap timer. The timer interface stops for 3 seconds and displays the time of the last lap. All previous lap times will be recorded in the lap timer list. The maximum number of laps is 99 and the minimum lap time must be over 3 seconds.

Lap Memory

Records the results from the lap timer.

Click [Lap Memory] to enter, the total time and average timing time will be displayed in the menu. Click  to return to the previous interface. The longest lap in the list is shown in red, while the shortest lap is shown in green.

Throttle Start Timer

To start the timer by a set throttle value. Click  to activate this function.

Click "+" or "-" to change the throttle start value. Press "+" or "-" for seconds to accelerate the throttle start value. You can stop the timer by clicking [TH Stop], and use "+" or "-" to change the throttle stop value. The value change level is 1, and the level range is -100 to 100. Note that the throttle stop value should be less than the throttle start value.

In addition, the timer can be quickly enabled and disabled by an assigned control through [ASSIGN]. Press the control for seconds to reset the timer.

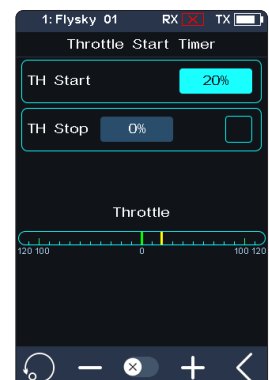
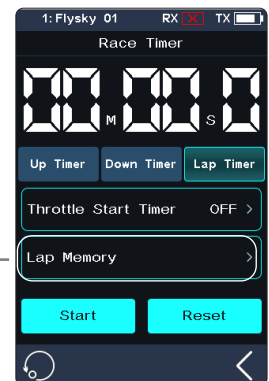
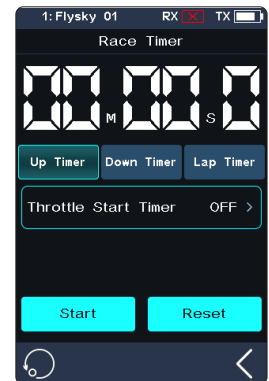

6.7 ASSIGN

The key assignment function is used to assign keys or switches to different functions for quick switch or control. If the base color of a control is green, indicating the control has been assigned.

A control can be assigned to control multiple functions at the same time. For an instance, a function can be controlled by the steering wheel and the throttle trigger.

The six keys or knobs (TR1-FB, TR1-LR, TR2-FB, TR2-LR, TR3, and TR4) have the same function and can be used to quickly adjust the values of multiple functions. It can be set to S DIR (single direction) or 2 DIR (dual direction) via Button Type. When the TR type is set to single direction, the assigned function and channel can be quickly enabled, disabled, or switched.

[Type]: Used to set the control to normal, 2-position or 3-position.

[Function] and [Function2]: Assign functions to this key or knob.

[Direction]: Used to set the NOR(normal) or REV(reverse) of this button or knob.



[Mode]: When "Trigger" is selected, channel data will change once through key triggering. Channel data will return to the state before key operation when the key is released. When "TURN" is selected, channel data remains in effect at the time of trigger if the button is rebounded.

[Step]: Step, which is used to adjust the value change of a single operation. "1" means move the key once, the value change level is 1, the level range is 1-120, the user can adjust it as needed.

Setup:

1. Touch [TR1-FB] or any of the other button icons.
 [Button Type S DIR]: means the key or knob can control enabling, disabling, or switching from one direction separately.
 [Button Type 2 DIR]: means the key or knob can adjust the function or channel values in two directions (upward and downward).
2. Click [Type], switch between [Normal], [2 POS], and [3 POS] as required.
3. Touch [Function] and [Function2] to enter the next menu, after selecting the function, click  to return to the previous interface.
4. Click the [NOR] option on the right side of [Direction]. Then, [REV] is displayed. It indicates the actual operation of this button is reversed with the output.
5. Click [Step], then use "+" or "-" to change the throttle start value.
 When Type is set to [2 POS] or [3 POS], the step can be adjusted.
 When Type is set to [3 POS], you can set the mode to Trigger or TURN.
6. Test to make sure everything is working as expected.

Switching to single direction

1. Click [TR1-FB] or other key icon to enter the submenu; then click [Button Type 2 DIR]. The system will prompt "Switch button type may cause current key setting to be lost, confirm and switch?", click [Yes] to switch [S DIR].
2. Click [TR1-F] or [TR1-B] to display the function setting interface.
3. Click the [Function] or [Function2] icon. Click  at the right side of the corresponding function. Click  to return to the previous level interface.
4. Click the [NOR] option on the right side of [Direction]. Then, [REV] is displayed. It

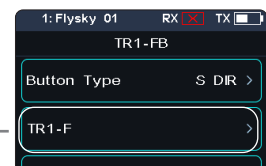
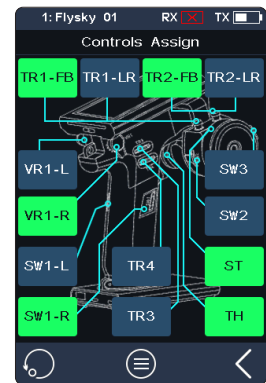

微信公众号



Bilibili



Website



Facebook

indicates the actual operation of this button is reversed with the output.

5. Click[Mode], then set the mode to Trigger or TURN.
6. Test to make sure everything is working as expected.

The functions of VR1-L and VR1-R are the same as above. When the VR type knob is set to 2-position or 3-position, it can be used to control the function on/off. By default, the low position is off, and the high position is on. You can switch the direction by Direction. However, the step is not adjustable.

When the VR knob type is set to Normal, you can customize the effective angle of the knob by Rate and Offset.

[Rate]: Used to set the size of the angle.

[Offset]: Used to set the neutral position of the angle



The keys of SW1L, SW1R, SW2 and SW3 can be used to control the enabling, disabling, or switching of multiple functions. The combination of SW2 and SW3 are used to adjust the values of the selected functions.

Note:

The default key type of the system is [Single Button]. Click the [Single button] icon on the right side of [Button Type] to switch to the combination key.

The operation procedure of this function is basically the same as the TR1-FB key setting.

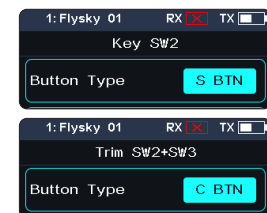

Key Assign

To view detailed information about the function assignment of all keys and knobs.

Click  to enter the [Keys Assign].

You can directly click the corresponding button to set the function.

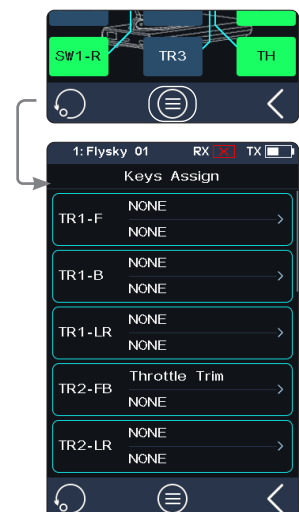

6.8 AUX

Noble Pro has two fixed channels. Channel 1 outputs steering and channel 2 outputs throttle. If you need to increase the fixed channel, you can use this function.

Note: The number of channels is subject to the [Channel Number Definition].

Channel name pre-selection:

1. Click [CH5 NONE] or other channels to enter the interface to set the channel name.
2. Click and then click at the right side of the corresponding channel as needed. Click to return to the previous level interface.
 - The channel will be occupied after selection.

To set the channel name:

3. Click the [Name] option to set the desired channel name. Press [Enter] for confirmation. Click to return to the previous level interface.

A name can be set to any combination of letters, numbers or symbols.

When some functional states are exactly opposite to the model actual state, it can be adjusted by the reverse switch function. After adjustment, the functional state is consistent with the model actual state.

Press to activate reverse function, then You can view the real-time status of functions via the home screen.



4. Sets a control to control the channel. Refer to [ASSIGN] for setting steps.

Click to enter the [Keys Assign]. In this list, you can view detailed information about the function assignment of all keys and knobs. You can directly click the corresponding button function to set the function.

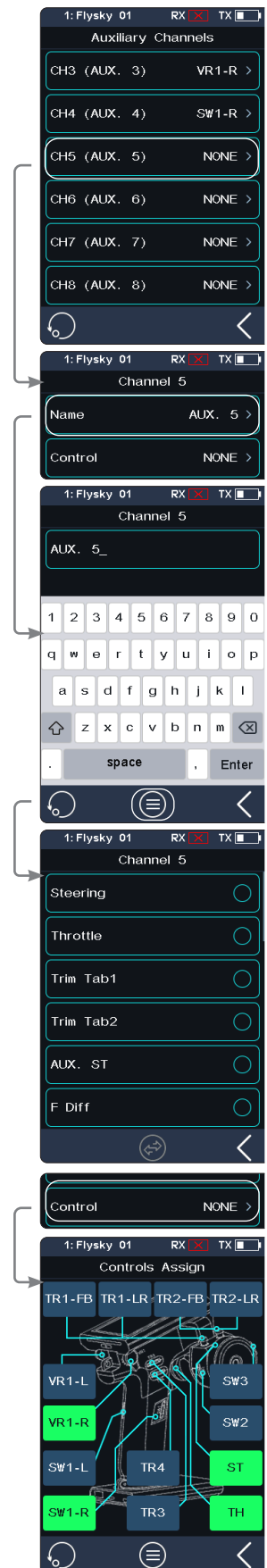

6.9 MODEL

The model functions are used to change, reset, rename, copy or customize the display and sorting of the main menu. The Noble Pro can store multiple sets of models.

Select Model

To select a model.

Tap Select Model, then touch a model from the list.

Auto Search Receiver

The model with successful two-way binding can be switched through the Auto Search Receiver function. Note that the model which is the receiver corresponding to must be in the power-on state.

Click , the system will prompt "Searching for receiver". When the model corresponding to the powered-on receiver is searched, it automatically switches to the model.

Model Name

To name the model.

After clicking [Name: FlySky 01], use the keyboard in the interface to type in a new name. When the setting is finished, click "Enter" to save the setting. Click  to return.

Channel Number Definition

This function is used to select the number of channels. If the larger number of channels is switched to the lower number of channels, the system will prompt "The model will reset need re-binding, Are you sure?". Click "Yes". Switching is successful.

When the lower number of channels is switched to the larger number of channels, model data will not be reset. The system will prompt "After switching you need re-binding, Are you sure?". Click "Yes". Switching is successful.

After choosing [CH2 (Fast)], only two channels for steering and throttle are retained. This makes operations easier and channel delay experiences are richer. It is suitable for new players and players who like different throttle speed experiences.

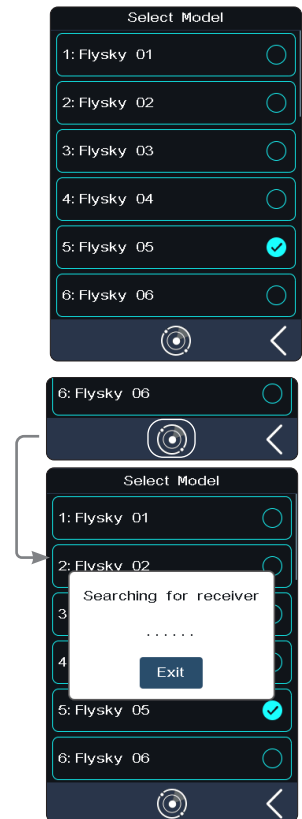

RF Setup

It includes RF protocol setup of the transmitter and receiver and RF module firmware update.

RF Standard

To select RF protocol of the transmitter and receiver.

[AFHDS3 one-way]: It features lower latency, allowing one transmitter to connect multiple receivers. It is applied when the model does not need any return data.

[AFHDS3 two-way]: With the two-way return function, it can return feedback data from receivers and sensors, and realize one transmitter to one receiver.

[Mini-Z(EVO)]: It is compatible with Kyosho miniZ EVO receiver. The number of channels is fixed (two channels: steering and throttle).

[Mini-Z(EVO2)]: It is compatible with Mini-Z RF3V2 receiver to control the cars of Kyosho miniZ EVO. The number of channels is fixed(two channels: steering and throttle).

[Mini-Z(FHSS)]: It is compatible with a Kyosho FHSS receiver to control the cars of Kyosho mini-Z FHSS. The number of channels is fixed (four channels).

FS-RM005 RF module supports a Noble Pro transmitter. It is only compatible with Kyosho Mini-Z (FHSS) cars.

Bind steps:

1. Remove the transmitter base's mobile power supply and insert the RF module into the transmitter base correctly (as shown in the figure on the right).
2. Click [MODEL]. Select the RF Setup as Mini-Z (FHSS).
3. Re-install the transmitter base power supply.
4. Connect the power cord to the transmitter. Press the receiver Bind key while connecting the receiver power supply. At this time, the receiver LED indicator flashes quickly.
 - Operation modes vary with receivers in case of their bind state.
5. Click [RX set], and select [Bind Set]. After the receiver LED state turns to slow flashing, the transmitter will automatically exit the bind state. When the receiver LED is solid on, it indicates the bind is successful.
6. Check whether the servo is working properly. If a binding is required again, repeat the above steps.

Change the RF protocol

1. Click [RF Std.] to enter the submenu.
2. Click at the right side of the corresponding function. Select "Yes" after the prompt box pops up and click to return to the previous interface.
 - If you switch the RF standard, the model will be reset and a binding is required again.

Update RF

The update RF function can be used to update the built-in RF module firmware. After the firmware of the transmitter is updated, you need to update the RF module firmware when the system prompts that the RF fails or the bind of the receiver fails.

Click [Update RF], Click "Yes" after the prompt interface pops up. An update progress bar appears. Wait a few seconds. The update is completed. The transmitter will automatically exit the update interface. If the transmitter cannot enter the update RF status, there may be no RF module or the RF module is faulty.

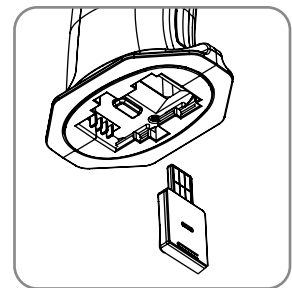
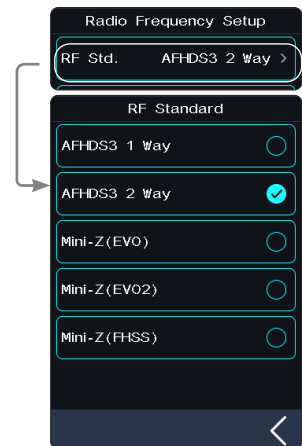

微信公众号



Bilibili



Website



Facebook

Custom Main Menu

You can customize the main menus sorting of and visibility of functions.

Click the small box, to select (show it in the menu) or deselect (hide from menu). If you need to adjust the menu order, select the menu you want to move (highlight is selected), then touch [Move up] and [Move down] to change its position in the menu.

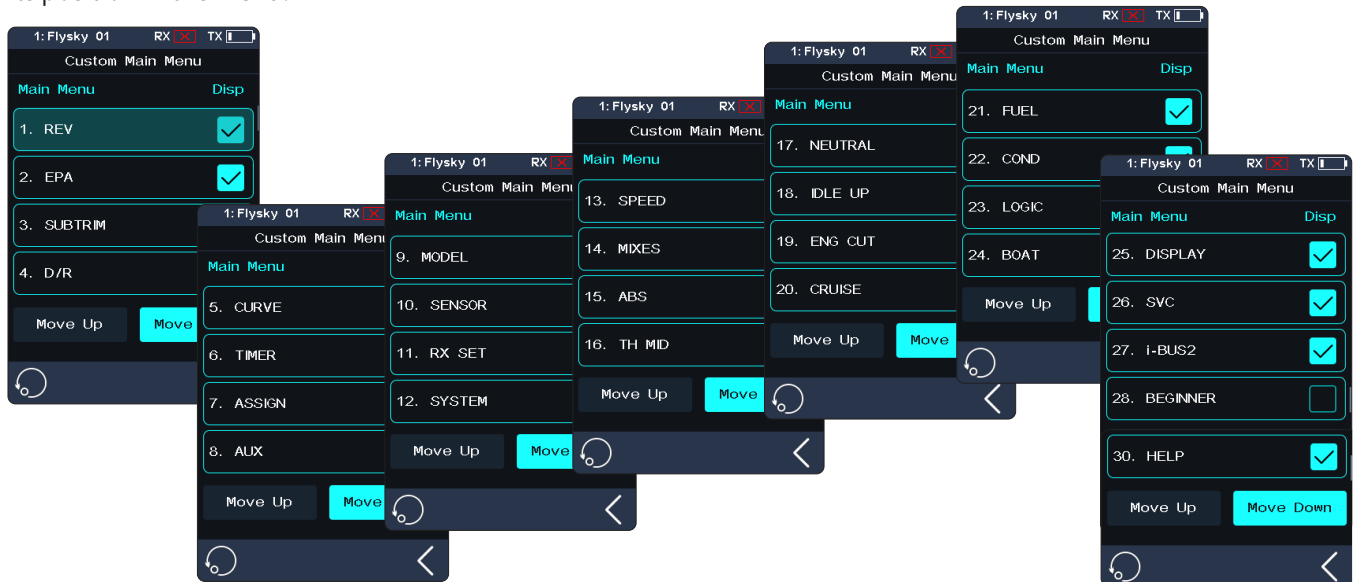

Model Reset

To reset a model.

Click Model Reset, then select Yes after the prompt box pops up to complete model reset.

Copy Model

To duplicate a model.

Click Copy Model, then touch the model to copy from the list. Next select a target slot from the list, this will overwrite everything in that slot. Then click Yes after the prompt box pops up.

Save As Default Data

To set the current model data to user default data.

Click [Save As Default Data], Then click Yes after the prompt box pops up. Note After operation [Factory reset], the data will be restored to the factory default data.

Reset To Default Data

To set the current model data to user default data.

Click [Reset To Default Data], Then click Yes after the prompt box pops up to reset.

Import or Export Model

You can import and export models by logging in to the FlySky official website to download the software (FlySky Assistant) and then operate it on the PC (No need go back to click the menu on the transmitter, you can operate it directly)!



6.10 SENSOR

This function can display the sensor information received by the receiver on the transmitter.

This function shows all sensors connected to the receiver, including sensor type, number and real-time data. It can also be accessed quickly from the home screen.

Display Sensors

This list displays all sensor data connected to this device, including sensor type, number, real-time data, and polarity and extreme values.

[Type]: To show the sensor type.

[ID]: To display the sensor's number.

By default, the number zero in the list includes the TX Voltage, RX Voltage, Signal, RSSI, Noise and SNR.

No. 1 is the return information of the Slave (secondary) receiver.

No. 2 is the first external sensor connected to the receiver, and so on, it supports up to 14 sensors.

This list data is displayed in real time. When the receiver is connected to a sensor, this list will be refreshed to display the new sensor's data. When the sensor is disconnected, the sensor data will not be displayed.

[Value]: To display the data returned by a sensor.

Sensor Limit Value: Displays the extreme value information of the connected sensor. Click  to enter the submenu which displays the limit value.

[Type]: To show the sensor type.

[Polarity]: To display the polarity to be recorded by the corresponding sensor, maximum, minimum, or "/".

[Value]: Record and display the actual limit value of the corresponding sensor.

To clear all records by clicking .

Note: "/" Indicates that the extreme value is not recorded.



Type	ID	Value
TX Voltage	0	3.94V
RX Voltage	0	4.68V
Signal	0	100
RSSI	0	-25dBm
SNR	0	78dB
Noise	0	-103dBm
BVD Voltage	0	0.05V

Type	Polarity	Value
TX Voltage	Min	3.91V
RX Voltage	Min	4.62V
Signal	Min	100
RSSI	Min	-37dBm
SNR	Min	60dB
Noise	Max	-101dBm
BVD Voltage	/	0.05V



微信公众号



Bilibili



Website



Facebook

i-BUS series sensor connection diagram

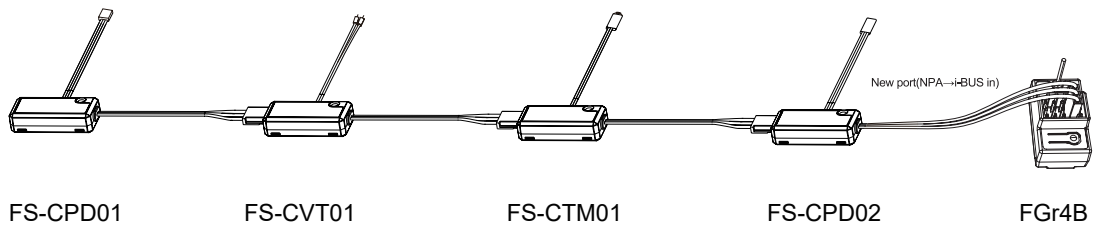
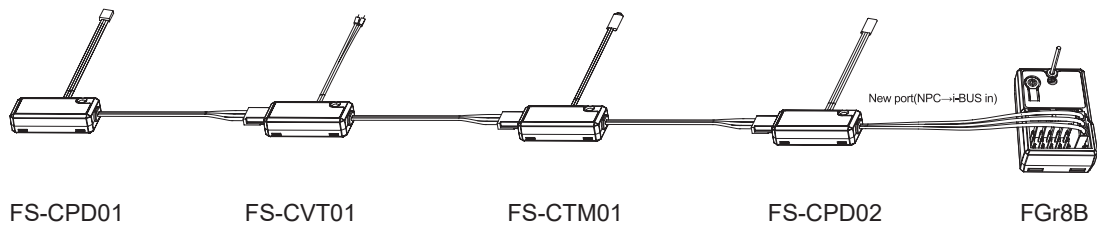

Note:

1. If using the classic version receivers, you must select the [RX Interface Protocol] in the [RX SET] menu and select [i-BUS], save and exit, then connect the sensor to the receiver's i-BUS port. All other steps remain the same.
2. If you use an enhanced version receiver, you need to set the New Port interface to i-BUS in.

Temperature Sensor (FS-CTM01)

Used to monitor the temperature of various components. Alarms can be set.

1. Connect the FS-CTM01 sensor to the receiver or other sensors connected to the receiver using the same method as shown above.
2. Use a spongy double-sided tape to stick the temperature probe to the part you wish to monitor (such as: motor, battery).
3. Turn on the transmitter, enter [SENSOR], then [Display Sensors]. If the "Type" column displays "Temperature" and the [Value] column displays a temperature, then the installation was successful, otherwise repeat the above steps.



Voltage Sensor (FS-CVT01)

It is used to monitor the model's battery voltage. The battery voltage can be monitored through from the transmitter. Alarms can be set.

1. Connect FS-CVT01 sensor to the receiver or other sensors using the same method as shown above.
2. Insert the red and black wire pins into the plug of the battery used for testing. The red wire is the power anode and the black wire is the power cathode.
3. Turn on the transmitter, enter [SENSOR] , then [Display Sensors] menu. If the "Type" column displays "External Voltage" and the [Value] column displays a voltage then the installation was successful, otherwise repeat the above steps.

Speed Sensor (FS-CPD01, FS-CPD02)

The speed sensor is applied to test the speed of the motor.

- "Motor Speed" indicates that the sensor is testing the motor speed; "0rpm" is the speed measurement value.

Magnetic Induction Speed Sensor (FS-CPD01)

1. Connect the FS-CPD01 sensor to the receiver or other sensors using the same method as shown above.
2. Place the sensor next to the magnet, which is fixed at the position of the axial rotation to be tested (e.g. inside the wheel hub of the model car).
3. Place the sensor within 2 mm of the magnet, with the south or north pole of the magnet parallel to the sensor.
4. Turn on the transmitter, and select [SENSOR] - [Display Sensors]. Turn the wheel. When the [Type] column shows RPM and the RPM value (0rpm) in the [Value] column changes. It indicates that installation is successful. Otherwise, repeat the above steps.

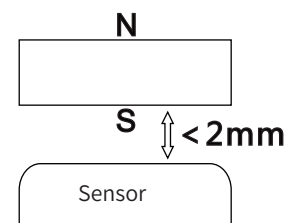
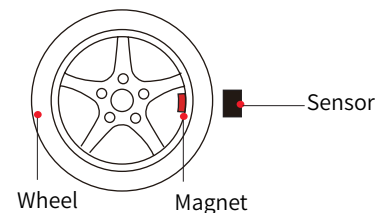

Light induction Speed Sensor (FS-CPD02)

1. Connect the FS-CPD02 sensor to the receiver or other sensors using the same method as shown above.
2. Fix the sensor and the reflective sticker at the position of the axial rotation to be tested. Keep the sticker flat and perpendicular to the sensor probe. Keep a moderate distance between the sensor probe and the sticker.
3. Turn on the transmitter, and select [SENSOR] - [Display Sensors]. Turn the wheel. When the [Type] column shows RPM and the RPM value (0rpm) in the [Value] column changes. It indicates that installation is successful. Otherwise, repeat the above steps.

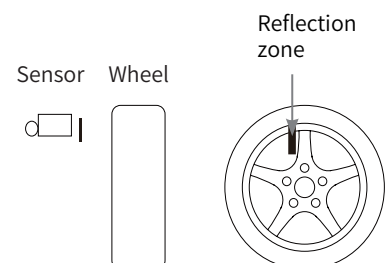

微信公众号



Bilibili



Website



Facebook

i-BUS2 series sensor connection diagram



Note:

1. The i-BUS2 series sensors are only compatible with AFHDS 3 enhanced version receivers. Take the FS-iBS01 sensor connection diagram as an example. The method for connecting other i-BUS2 sensors is the same.
2. The i-BUS2 series sensor must be connected to the New Port of the receiver, and set the New Port interface protocol to i-BUS2 via [RX SET]>[Receiver Interface Protocol].

i-BUS2 Optical Perception Sensor(FS-iBS01)

It is used to monitor the model's speed, such as motor speed. Alarms can be set.

- "Motor Speed" indicates that the sensor is testing the motor speed; "0rpm" is the speed measurement value.
1. Use 3M stickers to fix the optical perception sensor at the appropriate location of the model as shown in the figure. And make the optical perception detection element perpendicular to the reflective surface of the motor rotor. It should be noted that the fixed surface should be flat. You can also use a cable tie to tie it to the model. In this case, you should control the force.
 2. Connect the sensor to the receiver using the same method as shown above.
 3. Turn on the transmitter, enter [SENSOR] , then [Display Sensors] menu. When the [Type] column shows RPM and the RPM value (0rpm) in the [Value] column. It indicates that installation is successful. Otherwise, repeat the above steps.
 - The distance between the optical perception detection element and the propeller or rotor is not more than 50 mm or 30 mm (with a light shield).

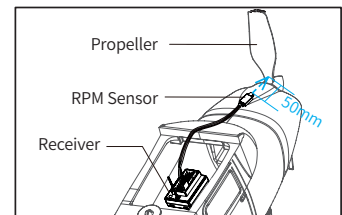

Note: Please refer to the FS-iBS01 manual for more details.

i-BUS2 Altitude Sensor(FS-iBA01)

It is used to monitor the model's altitude. Alarms can be set.

- "Air Pressure" indicates that the sensor is monitoring air pressure; "Height" means the height measurement, "Altitude" is the altitude measurement.
1. Use 3M stickers to fix the altitude sensor at the appropriate location of the model. It should be noted that the fixed surface should be flat. You can also use a cable tie to tie it to the model. In this case, you should control the force
 2. Connect the sensor to the receiver using the same method as shown



above.

3. Turn on the transmitter, enter [SENSOR] , then [Display Sensors] menu. When the [Type] column shows Air Pressure,Height, Altitude and their values in [Value] column. It indicates that installation is successful. Otherwise, repeat the above steps.

Note: Please refer to the FS-iBA01 manual for more details.

i-BUS2 Temperature Sensor(FS-iBT01)

It is used to monitor the model's temperature. Alarms can be set.

1. Use 3M stickers to fix the temperature sensor at the appropriate location of the model. It should be noted that the fixed surface should be flat. You can also use a cable tie to tie it to the model. In this case, you should control the force.
2. Use soft glue to stick the temperature detecting element on the parts to be detected, for example, motor, ESC or engine.
3. Connect the sensor to the receiver using the same method as shown above.
4. Turn on the transmitter, enter [SENSOR] , then [Display Sensors] menu. When the [Type] column shows Temperature and the value in [Value] column. It indicates that installation is successful. Otherwise, repeat the above steps.

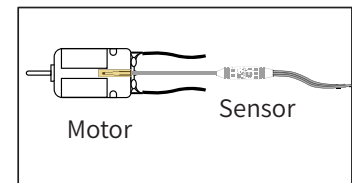

Note: Please refer to the FS-iBT01 manual for more details.



微信公众号



Bilibili



Website



Facebook

Choose Sensor



This function allows you to select the sensor to be displayed on the main screen and high and low alarm values for that sensor.

There are multiple sensor function settings under this function, such as [TX Voltage], [RX Voltage], [Signal Strength] and [RSSI], for setting high and low alarm values of the corresponding sensor. During the operating process of the transmitter, we cannot always pay attention to whether the power state of the receiver is sufficient. When the voltage of the receiver is too low, it may cause the power of the receiver to run out by continuing to use. Therefore, the low voltage alarm of the receiver can be set according to the demand to remind us that the power is too low and pay attention to charging.

For example, the Signal Strength Indication (RSSI). It refers to the distance between the transmitter and the model determined by received signal strength. A low signal strength indicates a weaker signal received by the receiver. This may cause the model to lose signals. A high signal strength indicates that the signal received is too strong, and this may interfere with the signals of the receiver and cause the model to lose control. Therefore, users can also choose to set the strong alarm alert.

Setup:

[TX voltage]

1. Enter this menu then touch  to enable this function. When this function is enabled, the icon will change to .
2. Click [Low Alarm] to select. [Value] is the corresponding status low alarm value. Touch the "+" or "-" icons to change the trigger value. The setting of [High Alarm] is the same.

[RX voltage], [Signal Strength], [RSSI] can all be set using the above instructions.

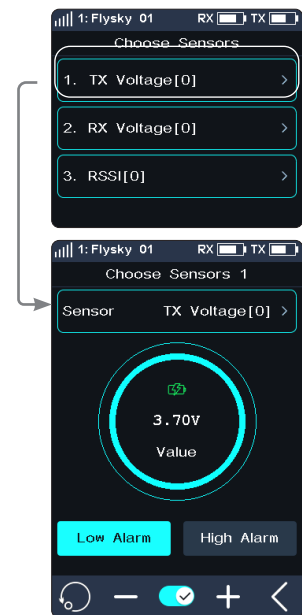

Data Record

Note: Before using this function, note that [RF Standard] needs to be set to [AFHDS3 2 Way].

This function is used to display and set data-record information.

To set the sensor to be recorded. Click to enter the setting interface.

To select the sensor to be viewed after clicking here, then the relevant data will be displayed in the upper coordinate.

Reset icon

Click to clear all recorded data.

It can also assign controls to reset data via [ASSIGN].



To display the actual page number of the coordinate diagram.

The start/stop/reset of Data Record can be controlled by an assigned control via [ASSIGN]. When a control is assigned, click the control to pause the data record, and hold the control for 2S to reset the record.

When the function is paused, swap the screen left and right to turn the page and view the related records.

To display data for the selected sensor. The horizontal axis represents the time, and the vertical axis represents the sensor value.

To disable or enable the function.



You can set the sensor to be recorded through Data Record Set.





[Record Duration]: Selects the maximum duration of a data record.

[Curve1~4]: Selects the function displayed the curve. Four curves can be set.

[Max Value]: Sets the maximum value corresponding to the function, that is, the value corresponding to the top of the vertical axis in the coordinate. If function of curve is set to Non-channel, this function item appears.

[Min Value]: Sets the value corresponding to the bottom of the vertical axis in the coordinate. If function of curve is set to Non-channel, this function item appears.

Setup:

1. Click [Data Record], then touch  to enable this function. When this function is enabled, the icon will change to .
2. Click  to enter data record set menu.
3. Click the curve to enter, then select a item as your desired. Click  to return.
4. Click [Max Value], then touch the "+" or "-" icons to change the value. The setting of [Min Value] is the same.



Supported Devices, Default Values and Setting Ranges of Data Record

Devices	Type	Default Value		Related Items for Setting		
		Min Value	Max Value	Setting Range	Step	Unit
Transmitter	Voltage	3	5	0~10	1	V
Receiver	Voltage	4	6	0~10	1	V
	BVD Voltage	5	10	0~100	1	V
Voltage Sensor	External Voltage	5	10	0~100	1	V
Temperature Sensor	Temperature	0	80	-100~200	10	°C
Altitude Sensor	Altitude	0	100	-1000~1000	10	m
RPM Sensor	Rotational Speed	0	5000	0~99900	100	rpm
	Speed	0	60	0~300	10	km/h
GPS	Speed	0	60	0~300	10	km/h
	Altitude	0	100	-1000~1000	10	m
	Acceleration	0	10	-20~20	1	m/s ²
MKS Servo	Angle	-80	80	-100~100	10	°
	Angular Velocity	-200	200	-1000~1000	10	°/s
	Voltage	4	6	0~10	1	V
	Current	0	10	0~100	1	A
PowerHD Servo	Temperature	0	80	-100~200	10	°C
	Voltage	4	6	0~20	1	V
	PWM Duty Cycle	0	100	0~100	10	/
HW ESC	Voltage	5	10	0~100	1	V
	Current	0	10	0~1000	1	A
	Rotational Speed	0	5000	0~99900	100	rpm
	Electricity Consumed	0	5000	0~99900	100	mAh
	ESC Temperature	0	80	-100~200	10	°C
	Motor Temperature	0	80	-100~200	10	°C



微信公众号



Bilibili



Website



Facebook

Speed And Distance

This function is used to detect motor wheel revolutions and distance traveled.

[Speed Sensor]: Select the target sensor. If the sensor and receiver are connected, the sensor will appear in this menu automatically. You can choose between two speeds or [None].

[Set Rotation Length]: If a speed sensor is installed on the wheel, you need to define the rotation length. This length will be used to calculate the distance traveled. Click "+" or "-" to adjust the length.

[Reset Odometer 1]: Odometer 1 is used to record the distance traveled.

[Reset Odometer 2]: Odometer 2 is used to record the total driving distance, that is, it is the cumulative distance.



Speed Sensor Set

This function is used to set the number of reflective spots on the corresponding sensor.

[Speed Sensor]: Select the sensor.

Click it to enter, then select the sensor. Click  to return.

[Reflective Spot]: To set the number of sensor reflective spots. Click "+" or "-" to adjust the length.

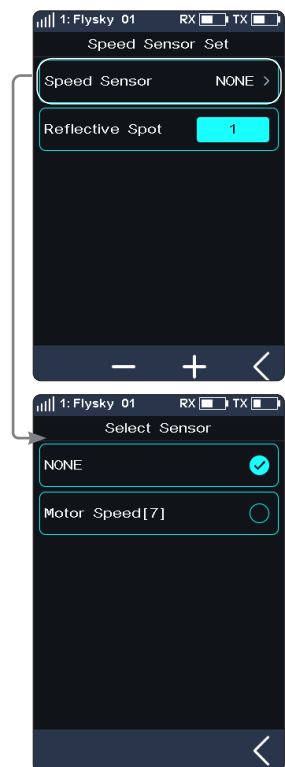

Altitude Zero Set

This function is used to set the current height to 0 m base height.

[Altitude Sensor]: To display the ID of the sensor. If multiple altitude sensors are connected, by default, this is sensor with the smallest ID.

[Current Height]: Display the real time height information after performing zero adjustment. otherwise, it is the actual altitude information.

After performing zero adjustment, the height information before and after zero adjustment will displayed in [Sensor List]. That is, it is height and altitude.

Click  to reset the current altitude to the actual altitude. After clicking, Select "Yes" after the prompt box pops up.



GPS Set

This function is applicable to GPS module of i-BUS2protocol. Through this function, you can set the standard time zone, perform gyroscope level calibration, and view GPS parameter display interface to get relevant information.  icon will appear in the top bar of the menu.

[UTC Select]: Sets UTC. Tap UTC select to enter, and tap an appropriate time zone. Then click  to return.

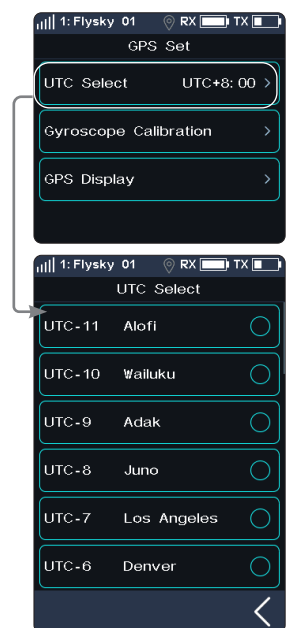

[Gyroscope Calibration]: Sets UTC. Calibrate the gyroscope. Before calibration, please connect the GPS sensor to the device correctly and make sure the device is placed horizontally. Tap Gyroscope Calibration to enter, then click Calibration. The system will calibrate automatically. When calibration succeeds or fails, the system prompts a pop-up screen with the success or failure of calibration. Recalibrate it in case of failure.

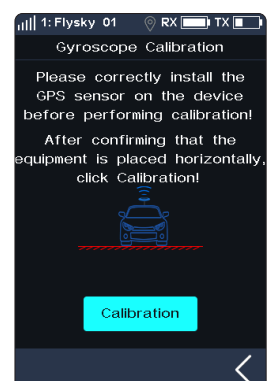

微信公众号



Bilibili



Website



Facebook

[GPS Display]: To display the information returned by the GPS sensor.

To display the number of satellites returned by GPS.

When the number of displayed satellites is more than 10, the GPS positioning accuracy is high, otherwise there is positioning error.

To show whether the positioning is successful or not. If the icon is blue indicating the positioning is successful, the icon is gray, then the positioning is failure.



To display the date and time in 24-hour clock.

Model data displaying area

To display the real-time latitude and longitude of the model.

To display the real-time latitude and longitude of the starting point.

Reset Icon
Reset the position of starting point to default value.



Azimuth angle shows the relative orientation of the model relative to the starting point.

Set the data source of yaw angle.

When checked, the data is from the gyroscope angle for calculation. If unchecked, the data comes from the actual motion condition.

1. The direction indicated by the green icon represents the real-time moving direction of the model. The center point indicates the starting position, and the outer circle indicates the relative orientation of the model. Click "+" or "-" to change the offset angle and the step is 10°.
2. The azimuth angle can be displayed in the home dashboard area through customization.

Attitude angle displays the real-time attitude information of the model relative to the horizontal position, including the pitch angle parallel to the direction of the connection line between the vehicle head and tail and the roll angle perpendicular to this line.

1. "+" indicates pitching up or rolling right; "-" indicates pitching down or rolling left.
2. The attitude angle can be displayed in the home dashboard area through customization.



Curr and Vol Sensor Set (Current and Voltage Sensor Set)

This function is adapted to i-BUS2 protocol current and voltage sensors, to reset sensor data and related max/min data.

[All Data]: Resets all data.

Tap [All Data], then select "Yes" after the prompt box pops up.

[Limit Value Reset]: Resets all extreme value.

Tap [Limit Value Reset], then select "Yes" after the prompt box pops up.

[Voltage CAL]: Calibrates the battery voltage. Note that properly connect the sensor's detection line to the device to be detected before starting calibration.

Setup:

1. Tap [Voltage CAL] to enter the next level interface;
2. Tap [Calibration], the system prompts that the calibration is successful. Click "OK" to finish the calibration.

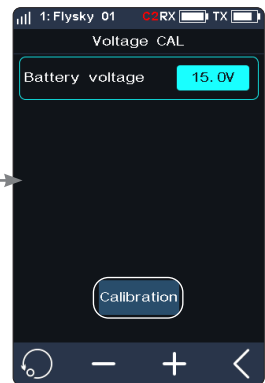
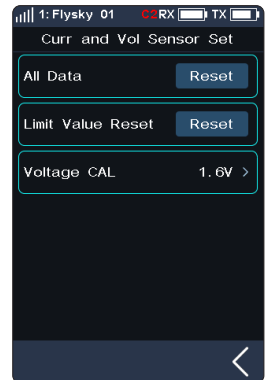

微信公众号



Bilibili



Website



Facebook

6.11 SPEED

This function allows you to set the steering speed, forward speed, brake speed and response speeds of CH3 to CH18.

The Condition function can be used for SPEED function, and you can set the rate parameter for both condition 1 and condition 1 respectively.

Note: the number of channels controlled is subject to the [Channel Number Definition].

[Steering]: Changes the corresponding speed of the servo when the steering channel is outputting at fast speed. The minimum delay is 0.00s, and maximum delay is 10.00s. The adjustment step is 0.01s.

This function can be used for adjustment when the vehicle is operated with fast steering, which may cause the vehicle to lose control or when the vehicle structure cannot withstand a too fast steering speed.

[Forward]: Sets the response speed of the throttle channel.

This function can be used to imitate models with slow acceleration and deceleration response (for example, large trucks).

[Brake]: Used for vehicle models.

The [Steering Speed Turn], [Steering Speed Reset], [Throttle Speed Go], [Throttle Speed Reset], [Brake Speed Go] and [Brake Speed Reset] can be adjusted after assigning VR and TR keys or knobs in the [Key Settings] function. A window will pop up when you adjust the real-time value by keys.

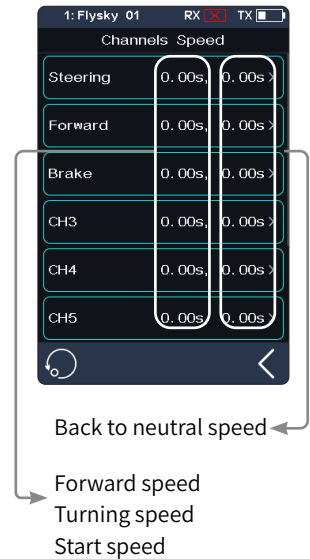

Channel Speed - Steering

Setup:

[Turn Speed]: Slow down channel output speed when the steering wheel is moving from the neutral position to maximum travel.

[Return speed]: Slow down channel output speed when the steering wheel returns to the center position.

1. Click [Turn Speed] or [Return Speed]. This item is highlighted when selected.
2. Click the "+" or "-" icon to change response duration as needed. And click the "+" or "-" icon to accelerate the adjustment duration.
3. Verify that the settings are normal as expected.

Progress bar 1: Show the channel output speed after the delay (as shown on the right).

Progress bar 2: Show the actual speed before the delay takes effect (as shown on the right).

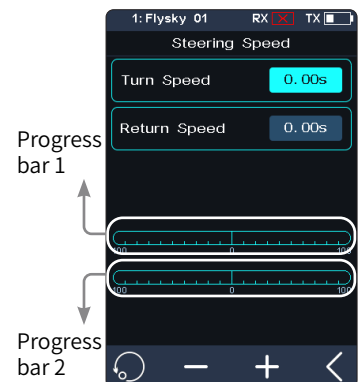

Channel Speed-Back/Brack

This function is only applicable to normal mode. It is not displayed in ship mode.

Setup:

[Go Speed]: Sets the speed of the throttle brake.

[Return speed]: Set the speed at which the throttle brake returns to the center position.

1. Click [Go Speed] or [Return Speed]. This item is highlighted when selected.
2. Click the "+" or "-" icon to change the response duration as needed. Press the "+" or "-" icon to accelerate adjustment duration.
3. Verify that settings are normal as expected.

Progress bar 1: Show the channel output speed after the delay (as shown on the right).

Progress bar 2: Show the actual speed before the delay takes effect (as shown on the right).

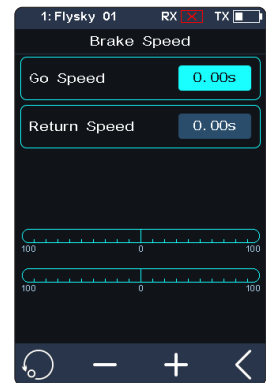

Channel Speed - Forward/Throttle

This function is used to set the delay of the throttle start and return-to-neutral.

[Go Speed]: Sets the speed of throttle acceleration.

[Return Speed]: Sets the speed at which the throttle returns to the neutral position.

[Point P1]: Means the division point between the first forward travel and the second forward travel. The default point is 30%, and adjustable range is 0-99%.

[Point P2]: Means the division point between the second forward travel and the third forward travel. The default point is 60%, and the adjustable range is 1-100%.

[L]: The first travel.

[M]: The second travel. It can be set under the menu of mode 2 and mode 3.

[H]: The third travel. It can be set under the menu of mode 3.

Setup:

1. Click the option that needs to be set. This item is highlighted when selected.
2. Click the "+" or "-" icon to change the response time or the percentage of the corresponding point as required. Press the "+" or "-" icon to accelerate adjustment of the corresponding value.
3. Verify the settings are normal as expected.
 - The percentage of point P1 differs from the percentage of point P2 by at least 1%. The lower the percentage, the slower the throttle channel responding to the throttle trigger operation.
4. Verify that settings are normal as expected.

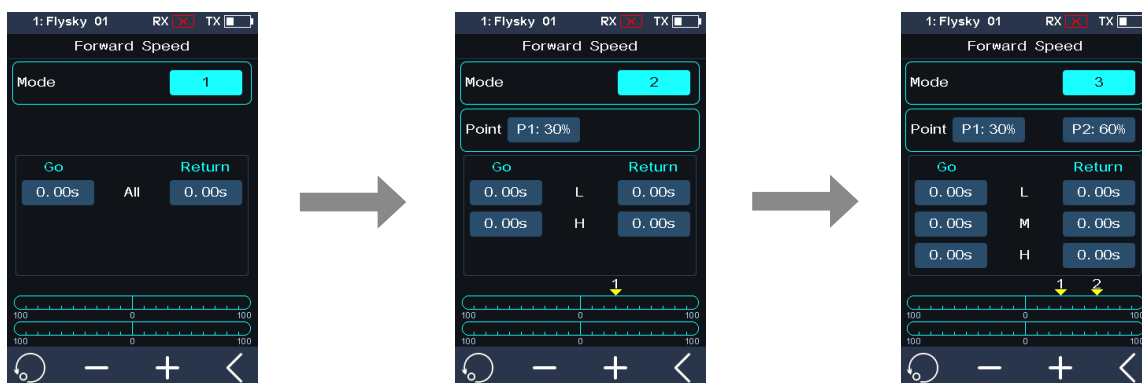

微信公众号



Bilibili



Website



Facebook

When the ship mode is enabled, the related menus are below.

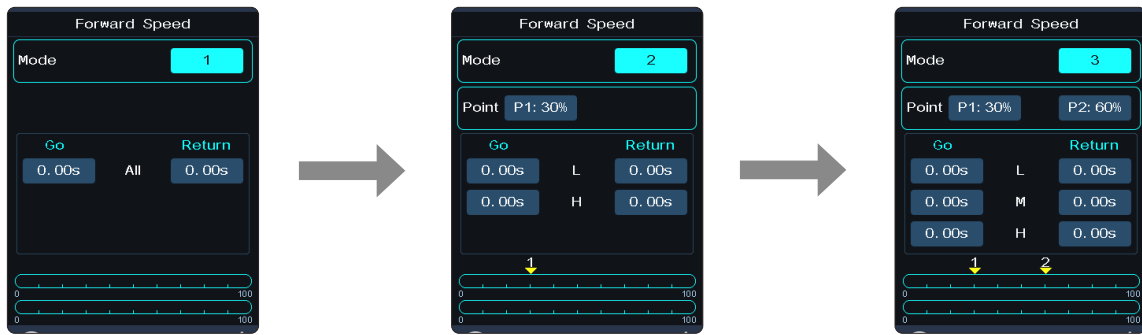

Channel Speed - CH3-CH8

This function is used to set the delay time of CH3-CH18 forward and return-to-neutral.

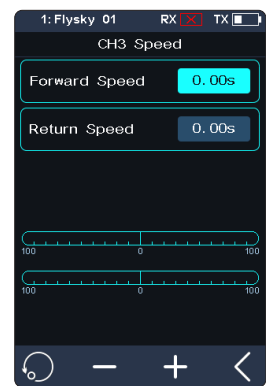

6.12 MIXES

This function allows you to set 5 mixing functions, that is, [4WS Mixing], [Track Mix], [Drive Mix], [Brake Mixing], and [Programming Mixes].

4WS Mixing

Used to set the wheels that control steering of the vehicle, front, rear or all four wheels.

This function is applicable to crawler with steering on both front and rear wheels.

By default, the front wheel steering is used in this function.

By default, the function is disabled.



[Mix Rate]: Set the amount of mixing from the steering channel mixing to the mixed channel. The adjustment range is 0-100%.

Setup:

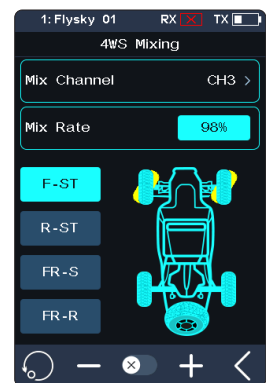
1. Click [Ch3] on the right side of [Mix Channel]. Click the right side on the corresponding channel. After selection, the channel will be occupied. Click to



return to the previous level interface.

- Each channel can only be assigned one mixing function. It is not allowed to conflict with other Func Assign channel. When the selected channel is assigned with other mixing functions, the system will give a pop-up window reminder.
2. Click the "+" or "-" icon to change the ratio as required. Press the "+" or "-" icon to accelerate the ratio adjustment.
 3. Click  to enter Controls Assign menu, then select the steering type as required. You can select [Steering Mix Mode] in the [Assign] function, and assign SW keys to switch four different functions. Alternatively, you can select [Steering Mix Rear], [Steering Mix Same] or [Steering Mix Reverse], to realize fast switch between this function and [Steering Mix Front] through SW key. Click  to return, after this function is enabled, the icon will change to .
 - You can select [4WS Mixing Rate]in[ASSIGN], assign VR, TR key or knob for adjustment, and when adjusting by key, a pop-up window will appear in the adjustment by pressing the key, prompting the real-time value.
 4. Verify the settings are normal as expected.

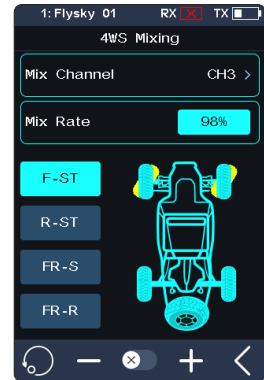

Track Mix

This function is applicable to models such as tracked vehicles and tanks, and allows one trigger or steering wheel to control the left and right tracks to move forward or steering differently at the same time.

This function allows you to set the rates of forward, backward, left and right separately. The rate adjustment range is 0-100% and the adjustment step is 1%.

The left progress bar shows the channel value of CH1 left track. The right progress bar shows the channel value of CH2 right track. The figure on the left indicates the state of operating the throttle forward separately.

Setup:

1. Select the check box on the right side of [Track Mixing] to enable this function. After the function is enabled, the icon will be change .
2. Click the rate you want to set. The selected option is highlighted.
3. Click "+" or "-" icon to change the ratio as required. Press the "+" or "-" icon to accelerate rate adjustment.
 - The rate can be adjusted by selecting [Track Mixing Forward], [Track Mixing Backward], [Track Mixing Left] or [Track Mixing Right] in the [Key Setting] function, with assigning VR and TR keys or knobs for adjustment. A pop-up window will appear in the adjustment by pressing the key, prompting the real-time value.

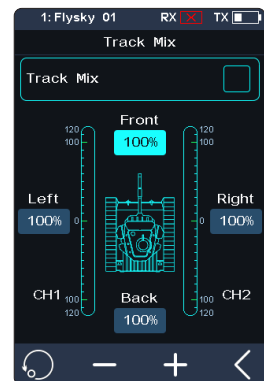

微信公众号



Bilibili



Website



Facebook





Drive Mix

Drive mix is used to set the way to control the vehicle engine drive, including three drive modes: rear drive, front and rear hybrid drive, and front drive. By default, rear drive is used.

Front drive has a shorter braking distance, which is suitable for emergency braking. In Rear drive, the front wheels can focus on steering, which is more suitable for vehicle drift. The F-R Drive (front and rear hybrid drive) is to drive the vehicle by starting all four wheels together, which can provide more traction to improve power of the vehicle in acceleration, hill climbing, and other roads.

[Mixing rate]: Include front rate (F) and rear rate (R) (100:100=F100%:R100%). The rate is only used when front and rear drive are mixed. The adjustment range of both front and rear rate is 0-100%, and the adjustment step is 1%.

Setup:

1. Click [Ch4] on the right side of [Mixing Channel]. Click the corresponding channel as required. This channel will be occupied after selection. Click  to return to the previous level interface.
 - Each channel can only be assigned one mixing function. It is not allowed to conflict with other Func Assign channel. When the selected channel is assigned with other mixing functions, the system will give a pop-up window reminder.
2. Click the "+" or "-" icon to change the rate as required. Press the "+" or "-" icon to accelerate the ratio adjustment.
 - When the mixing ratio is 100%:100%, the ratio of [R] decreases when you click "+", and the ratio of [F] decreases when you click "-". In any state, the percentage of [F] and [R] is kept at 100%.
3. Select the drive mode as needed. The figure on the right indicates the state of rear drive mode.
4. Click  to enter Controls assign menu. You can select [drive mix rate] under the function of [ASSIGN], assign VR and TR keys or knob for adjustment, A pop-up window will appear in the adjustment by pressing the key, prompting the real-time value. Click  to return, after this function is enabled, the icon will change to .
5. Verify the settings are normal as expected.

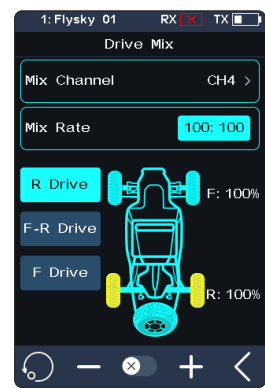



Brake Mixing

This function has two sets of brake mixing controls, to use multiple servos to control brakes; for example, models using different servos to control the front and rear brakes.

If your model uses multiple channels to control the brakes together, you can use this function to control the brake channel as a mixer channel for the throttle channel.

Setup:

1. Click [Brake Mixing 1 Off] option to enter the submenu.
2. Click [CH3] on the right side of [Mix Channel]. Click  on the right side of the corresponding channel as needed. This channel will be occupied after selection. Click  to return to the previous level interface.
 - Each channel can only be assigned one mixing function. It is not allowed



to conflict with other Func Assign channel. When the selected channel is assigned with other mixing functions, the system will give a pop-up window reminder.

3. Perform the settings by following the steps of setting the [EXP] and [ABS] function.
4. Use the servo display function. Verify that the settings are normal as expected.

You can select the menu corresponding to brake mixing under the [ASSIGN] function, assign VR, TR key or knob for adjustment. A pop-up window will appear in the adjustment by pressing the key, prompting the realtime value. Select [Brake Mixing 1 EXP Setting], [Brake Mixing 1 A.B.S.] or [Brake Mixing 2 EXP Setting], [Brake Mixing 2 A.B.S.] to assign SW keys to achieve two sets of brake mixing functions to enable/disable quickly.

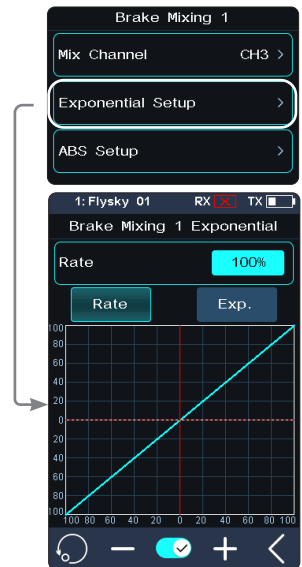

Programming Mixes

The Mixing function can be used to set the mix-control relationship between channels, containing a total of 8 groups of mixing relationships.

Setup:

1. Click [Mixing 1] or other mixing options as needed to enter the setting interface.
2. Click to enable this function. When this function is enabled, the icon will change to .
3. Click [Master Channel], select a primary channel from the list. The primary channel will affect the secondary channel.
4. Click [Slave Channel] and select a secondary channel from the list.
5. Select [Low Side Mixing] or [High Side Mixing] as needed. Click the "+" or "-" icon to change the percentage to adjust the amount of low end or high end mixing. Click to return to the previous menu when the setting is complete.
6. Click [Offset]. Then click the "+" or "-" icon to change the offset associated with the master channel and the slave channel.
7. Repeat the above operations to set other mixing controls.

Assign VR, TR keys or knobs in the [ASSIGN] function to adjust 8 groups of programmed mixing controls of [Low Side Mix], [High Side Mix] and [Offset] rates. A pop-up window will appear in the adjustment by pressing the key, prompting real-time value. In addition, it is possible to quickly enable or disable Mix 1 to Mix 8 functions by using the SW key.



微信公众号



Bilibili



Website



Facebook

6.13 ABS

A.B.S. stands for auto breaking system. This function is used to stop the wheels from locking which can lead to loss of control or a skid. A.B.S. manages this by regulating the amount of pressure the breaks use, which is done by pumping the breaks on and off rather than a constant force.



The Condition function can be used for ABS function, and you can set the ABS parameter for both condition 1 and condition 1 respectively.

There are six sub menus for A.B.S. function setting, [Brake Return], [Delay], [Cycle Length], [Trigger Point], [Duty Cycle], and [Steering Mix].

In the submenus, pulses are shown as a square wave, the peaks indicating brake on, and troughs in-dicating reduction in braking. As the value changes, the square wave will change to represent the function's current settings.

The trigger point is represented as a white line on the graph.

Below the graph is a bar that shows the real-time braking position. When this function is active and the brake is applied, the green bar will oscillate in real time showing the A.B.S. in action.

The function is disabled by default. Click  to enter Controls Assign menu. Assign a control to enable or disable the function. When this function is enabled, the icon will change to .



Brake Return

Control the reduction of braking during each pulse. Can be set to any value between 0% and 100%. By default it is set to 50%. If set to 60%, when the brakes are active; the system will remove 60% of the brakes strength on each pulse.

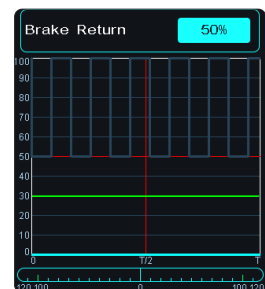

Delay

Determine how long it takes for the A.B.S. system to take effect. At a setting of 0%, the A.B.S. system will take effect as soon as the brake is applied. The higher the value, the longer it will take for the A.B.S. to function.

When the value is set to 0%, there will be no delay, meaning the breaks will be applied as soon as they are triggered. The maximum setting of 100% will result in a delay of 2 seconds.

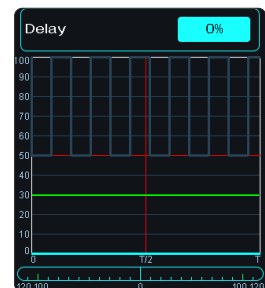

Cycle Length

Increase or decrease the time between pulses. It can be set to any value between 20% and 100%. By default it is set to 50%. The higher the value, the longer the pulse. The maximum setting of 100% will result in a cycle length of 0.5 seconds.

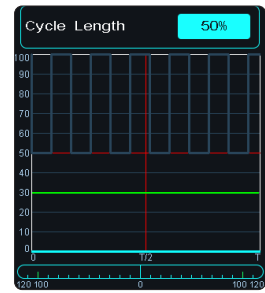

Trigger Point

Configure the point at which the A.B.S. starts to function. It can be set to any value between 20% and 100%. By default it is set to 30%. The higher the percentage, The closer the trigger position of the A.B.S. is to the full braking position.

0%-100% represents the entire braking travel movement of the throttle trigger.

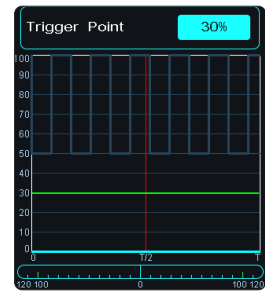

Duty Cycle

Change the length of each pulse and the gap between them. Adjustment range is from -4 to +4 cycles. By default it is 0. When the value is changed, the peak and trough lengths of the brake pulse's square wave change accordingly.

Adjusting the brake to release rate.

When the duty cycle is set to "0", the rate is 1: 1;

When the duty cycle is set to "1", the rate is 1: 2;

When the duty cycle is set to "-1", the rate is 2: 1.

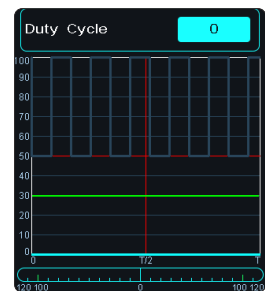

Steering Mix

A.B.S. can be enabled or disabled automatically while turning. This function mixes braking and steering to turn reduce the A.B.S. or replace it with a constant braking pressure.

The percentage represents the trigger position through its entire range of movement. E represents inside, N represents outside; if 50% N is set, the ABS function is to turn off when within 50% (10% N-50% N), and outside 50% (50% N-100% N) is to turn on the ABS function;

If 50% E is set, the ABS function will be turned on within 50% (10% E-50% E), and the ABS function will be turned off outside 50% (50% E-100% E).



Setup:

1. Touch  the enable function icon to enable this function.
2. Touch a setting to select it.
3. Touch the "+" or "-" icons to change the value.
4. Repeat as needed.
5. Test to make sure everything is working as expected.



微信公众号



Bilibili



Website



Facebook

6.14 TH MID

The throttle middle function is used to set the neutral position of the throttle and brake to correct the problem of unequal throttle travel and brake travel of some models. If the neutral position is not set correctly, the model may start acceleration and driving directly after power-on.

Setup:

1. Click the "+" or "-" icons to change the percentage as needed.
2. Verify the settings are normal as expected.

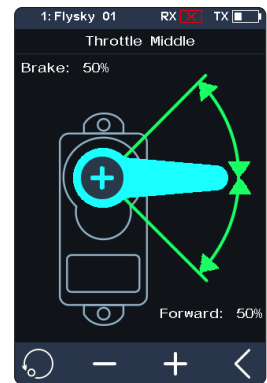

6.15 NEUTRAL

Throttle Neutral creates a configurable dead zone around neutral position for the throttle channel.

[Forward]: When it exceeds the dead zone, the throttle channel will output this value directly to accelerate forwards.

[Dead Zone]: The range of the dead zone. By default, the value is 0%.

[Backward]: When it exceeds the dead zone, the throttle channel will can be braked or ouput this value directly to accelerate forwards.

Setup:

1. Touch "Forward", "Dead Zone" or "Backward", select it.
2. Use the + and - icons to to change the percentage as needed.
3. Repeat with other settings as needed.
4. Test to make sure everything works as expected.

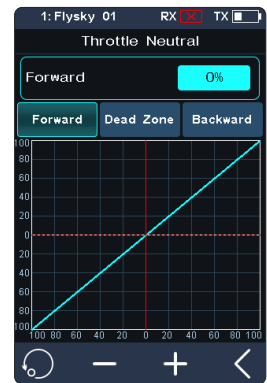



6.16 IDLE UP

The Throttle Idle Up function is used to set the engine idle when the trigger is in the neutral position. After setting the Idle Up function. Idle Up function makes sure that the engine always has some throttle in order to keep it from stalling.

This function is disabled by default.

[Lock Mode]: When the lock mode is disabled, the channel data continues to decrease when the trigger is pulled back. When lock mode is enabled, pull back the trigger, and the channel data locks to the set value.

Setup:

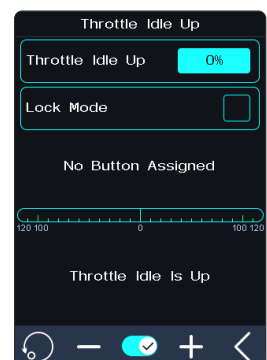

1. Click  to enter Controls Assign menu. Assign a control to enable or disable the function. When this function is enabled, the icon will change to .
2. Click the "+" or "-" icons to change the percentage as needed.
3. Test to make sure everything works as expected.



6.17 ENG CUT

When Engine Cut is triggered via a button it sets the throttle channel to a predefined position.

Setup:

1. Click  to enter Controls Assign menu. Assign a control to enable or disable the function. When this function is enabled, the icon will change to .
2. Click the "+" or "-" icons to change the percentage as needed.
3. Test to make sure everything works as expected.

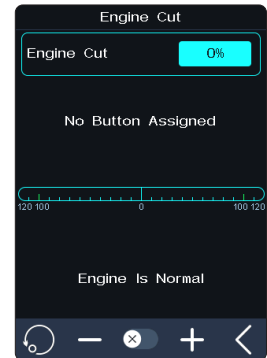

6.18 CRUISE



When the cruise function is enabled, the throttle channel remains the channel value output as power-on.

When the vehicle travels at the desired speed, the cruise function can be enabled, and the vehicle will continue to travel at the same speed after it is enabled.

The function interface displays the percentage of throttle channel output value in real time.

When the function is enabled, the system exits the fixed speed cruise if the trigger is detecting the braking state. At the same time, a pop-up window will appear, indicating that "Cruise control off".

Setup:

1. Click  to enter Controls Assign menu. Assign a control to enable or disable the function. When this function is enabled, the icon will change to .
 - Assign SW key (when TR1, TR2 key is in one-way mode, it can control the function to enable or disable) to enable/disable the cruise function quickly. A pop-up window will appear, indicating the current status.
 - Assign TR key (when SW2 and SW3 are in the state of key combination, the value can be adjusted) to adjust the value of the fixed speed cruise. A pop-up window will appear in the adjustment by pressing the key, prompting real-time value.
2. Click the "+" or "-" icons to change the percentage as needed.
 - The percentage cannot be adjusted when cruise function is not enabled.

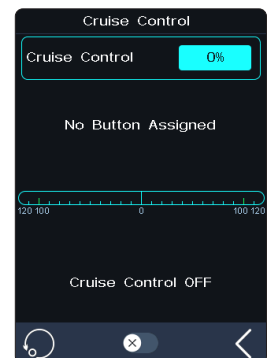

微信公众号



Bilibili



Website



Facebook

6.19 FUEL This function is available for version 1.0.3 or later.

The fuel consumption function is applicable to fuel vehicles, displaying the real-time fuel consumption. After this function is enabled, the  will be displayed in the status bar at the top of the main interface.

[Remaining Fuel]: Displays the actual remaining fuel quantity of the model vehicle in percentage.

[Tank Capacity]: Sets the capacity of the fuel tank of the model vehicle.



[Min Fuel C](Min fuel consumption): Sets the fuel consumption corresponding to the minimum throttle of the model vehicle.

[Max Fuel C](Max fuel consumption): Sets the fuel consumption corresponding to the maximum throttle of the model vehicle.

[Fuel Exp](Fuel consumption Exponential): Sets the rate of throttle trigger action to fuel consumption.

[Alarm Fuel]: Sets the fuel alarm. When the fuel is smaller than the set value, the transmitter will send an alarm.



Setup:

1. Click  to enable the function. When this function is enabled, the icon will change to .
2. Click the "+" or "-" icons to change the percentage as needed.
3. Test to make sure everything works as expected.





6.20 COND This function is available for version 1.0.3 or later.

You can set some functions and enable the condition mode. It supports two groups of condition mode in total(C1 and C2). You can set the condition mode in six functions, that is, [Dual ratio], [Curve], [Channel speed], [ABS], [Trim], and [Channel direction]. When the condition mode is enabled, the control must be set by [Key setting] to switch the condition mode. The default condition mode is C1.

When the function is enabled, the condition mode icon ( or ) is displayed in the status bar at the top of the main interface.

In practice, the setting parameters of the functions are different for the same function when a model vehicle runs on different roads. In this case, the condition mode can be switched to invoke different setting parameters.

Setup:

1. Tap the function.
2. Click  to enable the function. When this function is enabled, the icon will change to .
3. Set a control via ASSIGN function to switch between two conditions.
4. Access D/R function, then set the related parameters of D/R under condition 1.

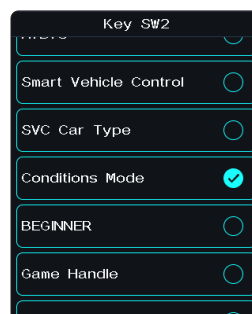
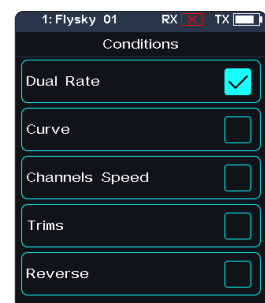

5. Switch to condition 2, then set the related parameters of D/R under condition 2.

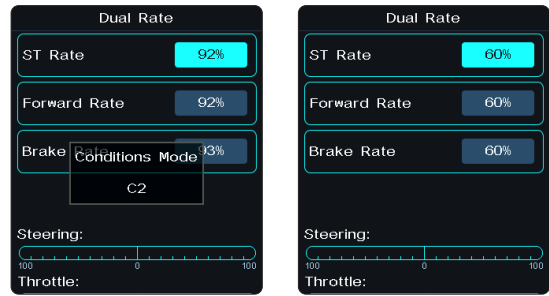

6.21 LOGIC This function is available for version 1.0.3 or later.

A logic switch is a virtual switch consisted of 2 switches.

If there is any mathematical logic relationship between certain switch controls and the other two switch controls, this function can be used to express this logic and use it as a logic switch in control.

The system supports to set two groups of logic switches in total. There are three logic definitions between two switches: AND, OR and XOR. [AND] If switch 1 and switch 2 are active, then the logic switch will be on. If either switch 1 or switch 2 is off, or switch 1 and switch 2 are both off, the logic switch is off. [OR] If either switch 1 or switch 2 is active, or switch 1 and switch 2 are both on, then the logic switch will be on. If switch 1 and switch 2 are both off, the logic switch will be off. [XOR] If either switch 1 or switch 2 is active, then the logic switch will be on, but if switch 1 and switch 2 are both active or off, the logic switch will be off.

[Logic Switch 1 or 2]: Sets the logic switch and click to enter the setting menu.

[Switch 1 or 2]: Sets a switch of the logic switch. Click to enter the submenu. then select an appropriate switch, click to return to the previous menu.

[Logic Relationship]: Sets the logic relationship. Click to enter the submenu. then select an appropriate logic relationship, click to return to the previous menu.

[Channel]: Sets a channel corresponding to the logic switch.

The logical relationship between logical switches are as following.

Switch	Logic Relationship											
	AND				OR				XOR			
Switch1	OFF	OFF	ON	ON	OFF	OFF	ON	ON	OFF	OFF	ON	ON
Switch2	OFF	ON	OFF	ON	OFF	ON	OFF	ON	OFF	ON	OFF	ON
Logic Switch	OFF	OFF	OFF	ON	OFF	ON	ON	ON	OFF	ON	ON	OFF

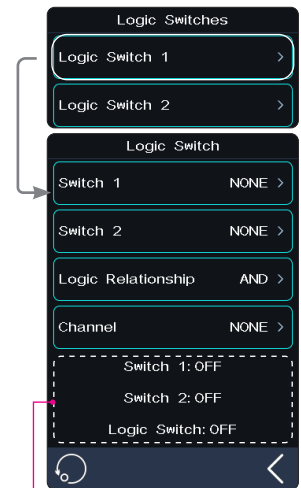

Status display: Displays the status of the two switches and the status of the logical switch after logical operation.

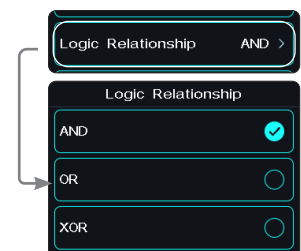
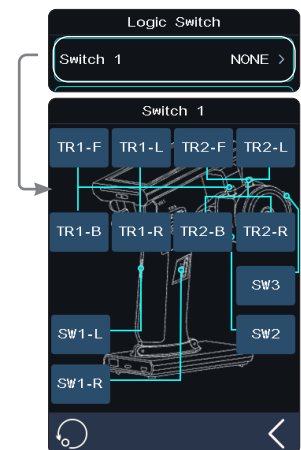

微信公众号



Bilibili



Website



Facebook

6.22 BOAT

This function is used only when you are using a model boat. When this function is active, the throttle channel is set to its lowest position and the brake functionality is disabled.

To enable this function, select [Boat] to switch to boat mode. When switching is successful, [Normal Mode] is changed to [Boat Mode]. The check box is selected.

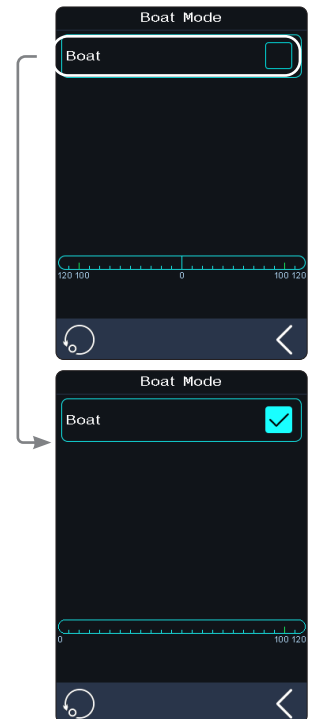

6.23 DISPLAY

This function displays the model's channel output and can be used to test output and servo range.

Press to start servo test mode, which will move all the channels slowly through their entire range of motion. Press to turn off servo test mode.

WARNING	<ul style="list-style-type: none">Make sure the model engine is powered off while the test function is activated.
----------------	---

Click to enter the channel display interface. In this list, you can view the data progress bar of all channels and the percentage data of channels.

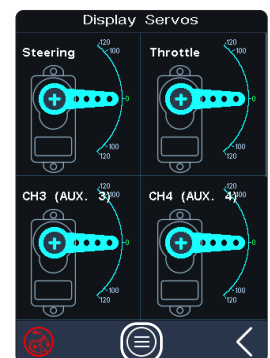

6.24 SVC

The receivers configured with this function are INr4-GYB (built-in gyroscope) and GMr (with gyroscope interface).

After the transmitter has bound with the receiver in two-way mode, press the SVC to access the function, coming along a prompt for gyroscope level calibration. It is recommended that the user should follow the prompt on the interface to complete the gyroscope calibration when using the gyroscope for the first time.

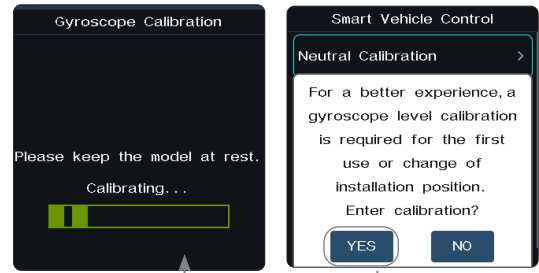

Neutral Calibration

Used for gyroscope to calibrate steering and throttle neutral to make the best driving condition when the vehicle is driving normally.

Before enabling the intelligent vehicle control function, you need to adjust the vehicle's steering servo volume, neutral trim and throttle neutral to the best driving condition. After completion, start the [Smart Vehicle Control] function for neutral calibration. Every time you change the trim or throttle curve, you need to calibrate the neutral position. The steering throttle should be placed in the neutral stationary state during the calibration process.

Reverse

You can set the positive and negative direction of the gyroscope in the mix-control of the direction channel.

ESP Mode

Used for model assisted stability. Two modes are available: normal/lock.

[Normal]: When the vehicle is yawing or steering, the gyroscope automatically provides an opposite compensation to control the servo to keep it stable or prevent drifting according to the angular velocity generated.

[Lock]: If the steering wheel is return-to-center, the gyroscope will control the servo in the opposite direction according to the yaw angle when the vehicle is yawing, to make it go back to the expected direction (if the steering wheel is not return-to-center in the "Lock mode", it will be the same as the "Normal mode").

Steering Gain

Used to change the sensitivity of the mixing direction.

Throttle Gain

Used to change the mixing throttle sensitivity.

Priority

Used to set the control ratio between steering wheel control and gyroscope in the steering, i.e., turning radius. In direction turning by using the steering wheel, the steering angle will be reduced due to the influence of gyroscope mixing. When

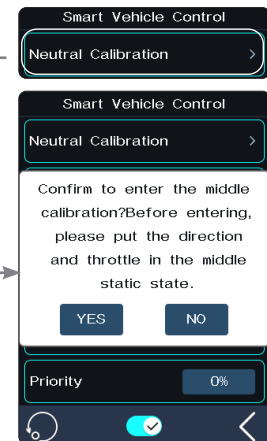
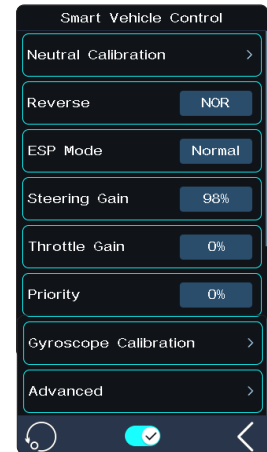

微信公众号



Bilibili



Website



Facebook

the value is 0%, the mixing control is the strongest, that is, the turning radius is the largest. When the value is 100%, the mixing control is 0, that is, the turning radius is the smallest.

Gyroscope Calibration

Used for the first time to enable the gyroscope via binding or gyroscope calibration required after replacement. The model keeps a stable and stationary state. Click calibration. The receiver flashes twice and exits automatically. This indicates that the calibration is successful.

(The above are the adjustable parameters when the transmitter is adapted to the GMr receiver and FS-GY01 gyroscope, and it is also adjustable when it is adapted to the INr4-GYB receiver.)

Advanced

To adapt INr4-GYB receiver compatible with model drift cars, etc. You can set type of the model cars, and customize parameters for [ST Wheel Gain], [Damper Point], [Damper] and [Filter].



[ST Wheel Gain]: Adjustment of intervention ratio of steering operation to gyro control, It is more sensitive in the steering control when the value increases.

[Damper Point]: Adjusts the servo to the damper point in front of the target angle position. In the damping interval, the servo oscillation speed will be slowed down. The higher the value, the larger the interval in which the servo speed is slowed down.

[Damper]: Slow down the servo speed in the damper point, and adjust the damping effect in the damper point. The higher the value, the slower the servo slowing down in the damper point. As a result, it takes longer time for the servo to reach the target angle. This parameter needs to be set together with [Damper point] to achieve the best result.

[Filter]: Used to suppress jitter. The higher the value, the stronger the jitter suppression.

Setup:

1. Tap  to enable this function. When this function is enabled, the icon will change to .
 - If the gyroscope is not connected, this function cannot be activated, and the system prompts "The current receiver is not properly connected to the gyroscope".
2. Click [Neutral calibration]. A pop-up box will appear "Are you sure you want to enter neutral calibration? Put the steering and throttle in the neutral stationary state before entering". Click "Yes". The transmitter enters the calibration state. The system prompts successful calibration with sound reminder.
3. If you want to change the direction of action, please click [Reverse]. If the function is set to reverse, it will show "Reverse";
 - The method of replacing EPS is the same as above.
4. Under this function, you can also set the percentages of [Steering Gain], [Throttle Gain], and [Priority]. The adjustable percentages range is 0% to 100%. After selecting the option, click the "+" or "-" icon to change the percentage.
5. Click [Gyroscope calibration]. A pop-up box will appear, indicating "Are you sure you want to start the calibration". The system prompts successful calibration

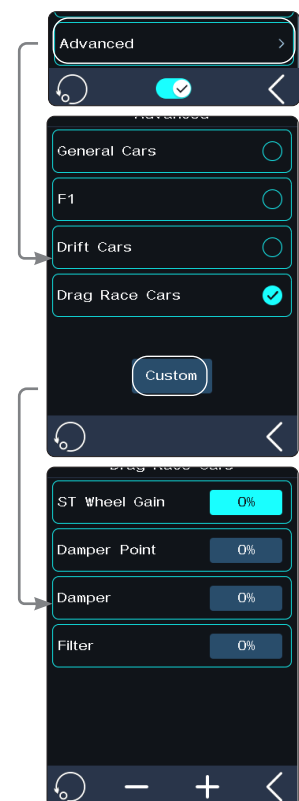
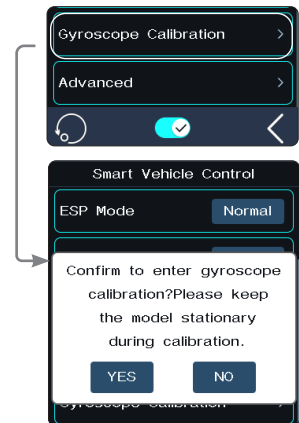

with sound reminder.



- When calibrating the gyroscope, please make sure the model is in a stable and stationary state.
6. Tap [Advanced], then select a type for the model car. After clicking [Custom], tap an item you want to set among [ST Wheel Gain], [Damper Point], [Damper] and [Filter]. Afterwards, click the "+" or "-" to set to the desired value.

6.25 BEGINNER

The beginner mode is suitable for entry level players to improve the safety of operations by limiting the amount of throttle servo.

This function is hidden by default. You need to enable it manually via [MODEL]>[Custom Main Menu].

Setup:

1. Go to the [Custom Main Menu] menu under the [MODEL] menu, and select the [Beginner] check box. After selection, this function is displayed on the menu interface.
2. Find the function in the menu and click  to enable this function. When this function is enabled, the icon will change to .

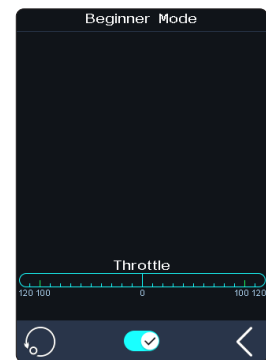

6.26 i-BUS2 This function is available for version 1.0.3 or later.

The i-BUS2 device settings function is used to set up the i-BUS2 devices, such as FS-iBH07 Hub or i-BUS2 protocol servo.

- At the transmitter side, you firstly need to set the receiver interface to be connected to the iBUS2 device as i-BUS2 via [RX interface protocol] function.

If the transmitter is normally connected to the i-BUS2 HUB, you can set it as PWM converter.

If the transmitter is normally connected to the i-BUS2 sensor type device, you can access the sensor setting interface through this function.

If the transmitter is normally connected to the i-BUS2 type servo or ESC, you can set the relevant function parameters, monitor data, and assign channels for controlling devices.

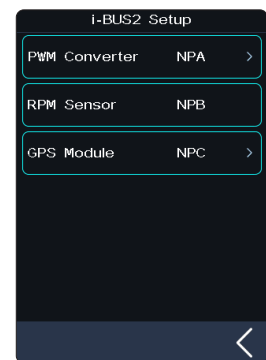

FS-iBH07 Extender

When the transmitter detects the i-BUS2 HUB device, the i-BUS2 HUB device can be set as a PWM converter or reset it back to the i-BUS2 HUB device via this function.

Setup:

1. Click [i-BUS2 Setup] to enter the setting menu.



微信公众号



Bilibili



Website



Facebook

2. Tap [i-BH07 Extender NPA], then click [Set to PWM converter]. After click [OK] in the pop-up window, tap [PWM Converter NPA].
3. Tap [Set to i-BUS2 Extender] to set it back to HUB. Click a channel to set as the output channel of the converter.
4. Tap  to return, a prompt pop-up window comes along with it "Whether to set the frequency of PWM converter synchronous", then click [YES] or [NO] to exit. If you select YES, it will be synchronous, otherwise, it's in the contrary.
 - The voltage returned from the extender can be displayed in real time in the [Sensor] menu.
 - When a servo is connected to the interface set to i-BUS2 protocol, it will display the servo type and the interface in [i-BUS2 Setup] menu.



i-BUS2 SENSOR

When the transmitter detects an i-BUS2 sensor, you can set the function parameters of the sensor in this function. Refer to 6.10 SENSOR for more details.

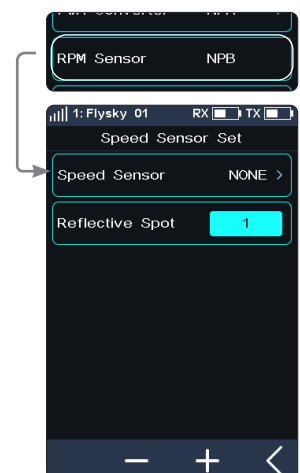

i-BUS2 SERVOS (FXS260/380)

When the transmitter detects the i-BUS2 FXS260/380 servo, you can use this function to set the relevant function parameters of the servo, monitor the information returned from the servo, and assign the channel for controlling the servo.

Servo Setup

Sets the function parameters to adjust the corresponding servo.

[Soft Start]: Sets the response speed of the servo instant startup.

[Thermal Protection]: Enables/disables the thermal protection function of the servo.

[Power]: Sets the output power of the servo when it is working.

[Boost]: Sets the voltage of the servo instant startup, so as to change the startup strength of the servo.

Setup:

Select the function item, then click the "+" or "-" icon to change the percentage or the option.



Data Sense

Monitors the return information from the corresponding servo.

Tap  to enter the Data Sense interface.

Channel

Assigns the corresponding channel to control this servo.

Tap [Channel: Steering >] to enter, then tap  at the right side of the appropriate channel. Afterwards, click  to return to the previous interface.



微信公众号



Bilibili



Website





Facebook



i-BUS2 SERVOS (PowerHD)

When the transmitter detects an i-BUS2 servo (PowerHD), you can use this function to set the relevant function parameters of the servo, monitor the information returned from the servo, and assign the channel for controlling the servo.

The settings of PowerHD servo parameters are similar to those of the FXS260/380. Refer to the description of FXS260/380 servos. You can save PowerHD servo parameters as two sets of configuration parameters. Two sets of commonly used parameters can be saved as Configurations 1 and 2, respectively. Both can be switched by setting a control.

Setup:

1. Two sets of commonly used parameters can be set and saved as Configurations 1 and 2 by tapping Save config 1 or Save config 2, respectively.
2. Tap  to enter Config Switch Switch interface.
3. Select a control, then tap  to enable this function. When this function is enabled, the icon will change to . Then the two sets of configurations can be switch by this control.

Click  to reset the settings to the default data, that is, data of Configuration 1. If the data of Configuration 1 is not set when you click  to reset the data. The system prompts to save the data of Configuration 1 first.

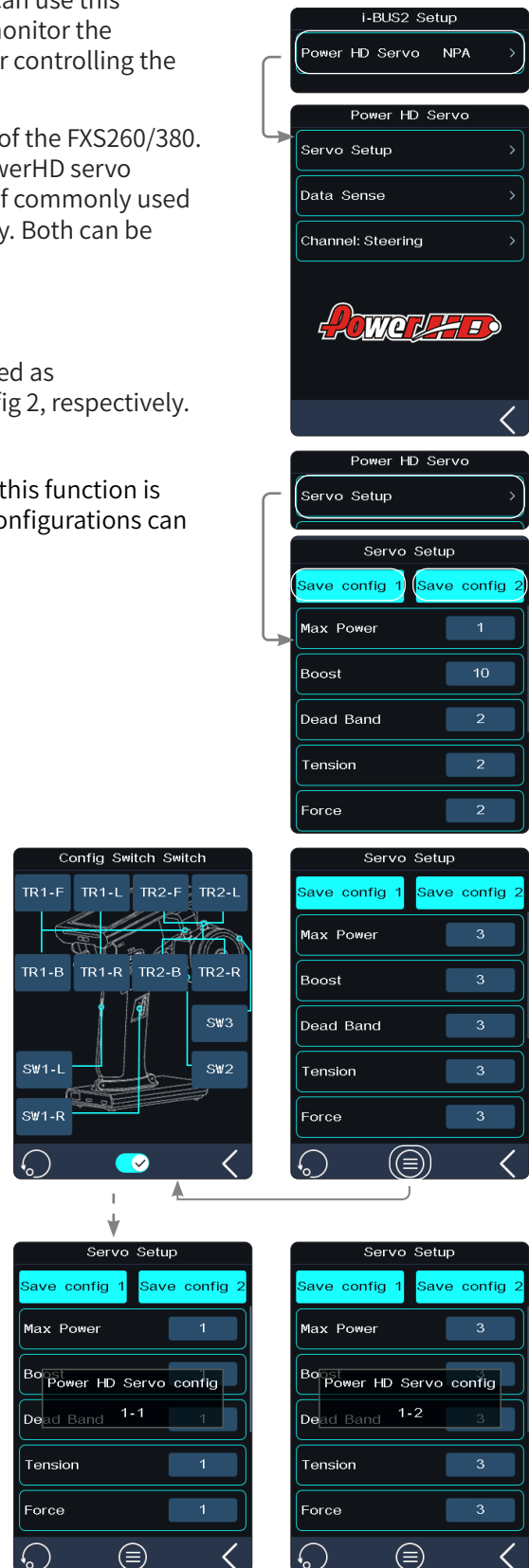

About the setting of PowerHD servo on Data Sense and Channel, Refer to the description of FXS260/380 servos.





i-BUS2 ESC (XERUN AXE R2)

When the transmitter detects an i-BUS2 i-BUS2 XERUN AXE R2 ESC, you can use this function to set the relevant function parameters of the ESC.

Servo Setup

Sets the function parameters to adjust the corresponding ESC

Note: To ensure correct operations, you must click  to confirm the updated parameters after the parameters are set. Then, click  to return. The parameter settings of ESC will take effect (at the same time, the ESC will make an audible prompt).

Setup:

Select the function item, then click the "+" or "-" icon to change the percentage or the option.



Data Sense

Monitors the return information from the corresponding ESC.

Tap  to enter the Data Sense interface.

Channel

Assigns the corresponding channel to control this ESC.

Tap [Channel: Steering >] to enter, then tap  at the right side of the appropriate channel. Afterwards, click  to return to the previous interface.

Note: For details about ESC parameters, see the corresponding manual of ESC.

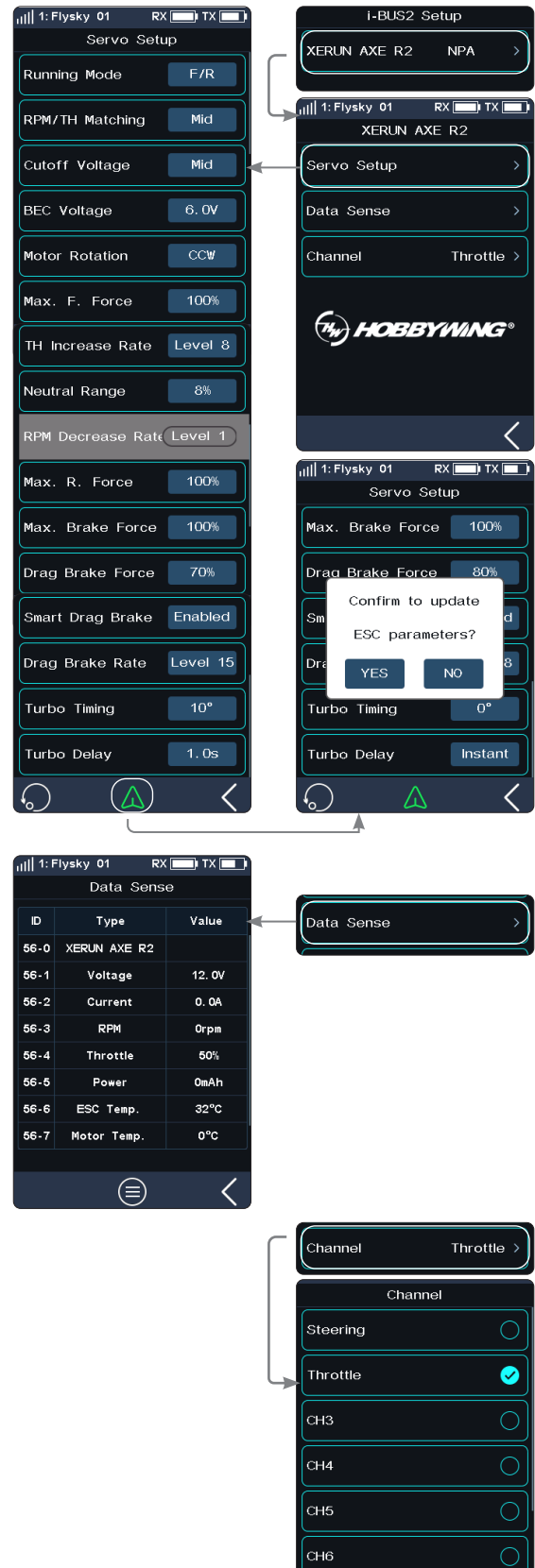

微信公众号



Bilibili



Website



Facebook

6.27 HANDLE This function is available for version 1.0.3 or later.

It is used to allocate and monitor the controls of the external USB devices of the base. To replace the transmitter controls with external USB device controls to control the transmitter's channels or functions, use the [HANDLE](gamepad) function.

Assign Control

Used to assign a channel or function to the selected control.

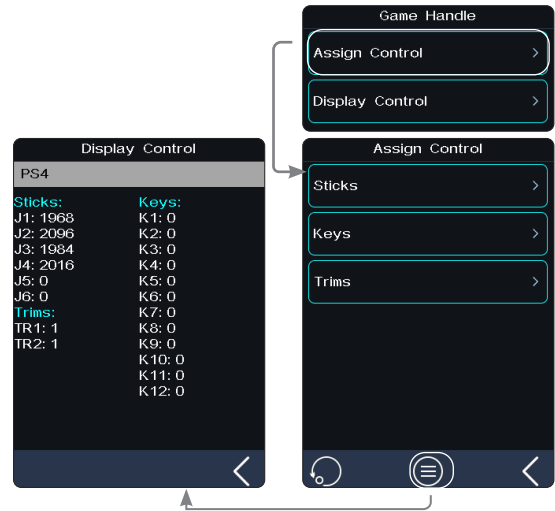

Sticks

The joystick control assigns the channel or function, to allow users to set relevant functions.

[Function] : Sets the function of the selected control.

[Direction]: Sets the data direction of the selected control. It can be set to NOR or REV.

[Dead Zone]: Sets the neutral dead zone value of the automatic self-centering joystick.

Setup:

Tap the stick to enter, then click the "+" or "-" icon to change the percentage or the option.

Tap to enter the Display Control interface, to allow users to monitor all control information, such as name and status.



Keys

The button control assigns the channel or function, to allow users to set relevant functions.

[Mode] : Sets the effective button mode. It can be set to Turn or Trigger, the Trigger mode is the default mode.

For the [Function] and [direction] descriptions, refer to the descriptions of Sticks.

The settings of Keys are similar to those of the Sticks, refer to the description of the Sticks.

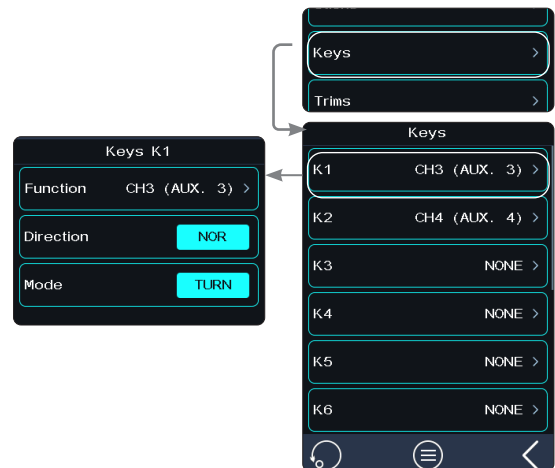

Trims

The trim control assigns the channel or function, to allow users to set relevant functions.

[Step] : Sets the valid value for each operation of the trim control.

For the [Function] and [direction] descriptions, refer to the descriptions of Sticks.

The settings of Keys are similar to those of the Sticks, refer to the description of the Sticks.

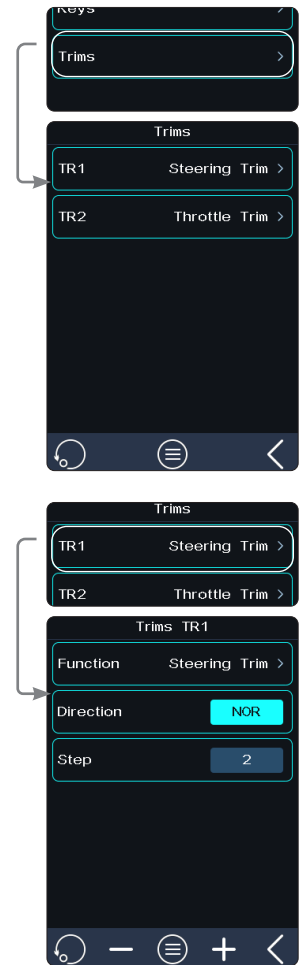

Display Control

Displays the raw data and assignment status of all controls.

Setup:

Tap [Display Control] to enter. Then you can view the related information.

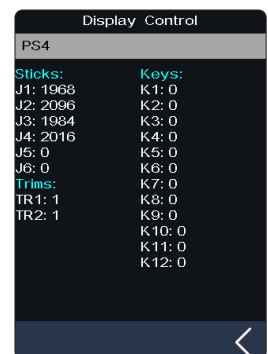

微信公众号



Bilibili



Website



Facebook

6.28 HELP

To obtain the user manual via this function. Users can contact us through social accounts listed on the interface. Users can call up the QR code and scan the code according to their needs.

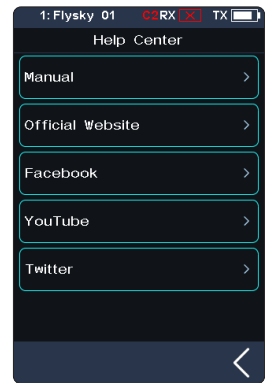

7 RX SET

7.1 Bind Set

This function is used to adjust the transmitter to the bind state so that it can bind with the receiver.

Noble Pro supports a dual-receiver mode. The ex-factory bind settings of the transmitter and receiver are completed successfully.

If you need to re-bind, please follow the following steps for the bind between the transmitter and receiver.

Classic Version (take FGr4P as an example)



Classic version receiver mode is only applicable to adaptations between the transmitter and receivers such as FGr4, FGr4S, FGr4P, FTr4, FTr10 and FTr16S.

1. Insert the bind cable into the receiver's Bind port, and plug the power cable into any other port. At this time, the receiver LED will flash quickly.
2. Turn on the transmitter. Click  and enter the [RX SET], and select [Bind Set] in the menu.
3. Click [Classic RX]. Then click [Start Bind]:
 - When the RF standard selection is AFHDS 3 2 way, the receiver LED is solid on, indicating the bind is successful. The transmitter will automatically exit the bind interface.
 - When the RF standard selection is AFHDS 3 1 way, the receiver LED flashes slowly, after the receiver LED becomes slow flashing, then put the transmitter to exit the binding state. At this time, the receiver LED is solid on indicating the binding is successful.
4. The bind is successful. Take off the bind line and power cord from the receiver.
5. Reconnect the power cord to the receiver. Check whether the servo is working properly. If a bind is required again, repeat the above steps.



Enhanced Version (take FGr8B as an example)

In the use of an enhanced receiver, if one receiver cannot meet the demand, you can use the dual-receiver mode.

1. Press the Bind button on the receiver for seconds, and then connect the power cord to any interface on the receiver. At this time, the receiver LED will flash quickly.
 - Please make sure your transmitter is not connected to other receivers before binding.
2. Turn on the transmitter. Click  and enter the [RX SET], and select [Bind Set] in the menu.
3. Click [Enhanced RX]. The system prompts "After switching you need re-binding, Are you sure?". Then click [Yes].
4. Click [Set Start CH]. And click  on the right side of the corresponding channel. After selection, this channel will become the first channel to receive transmitter signals. Click  to return to the previous level interface.

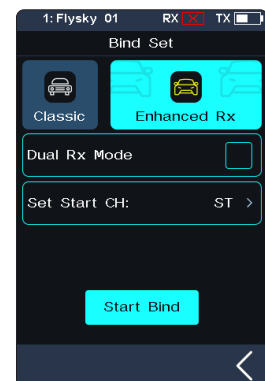

微信公众号



Bilibili



Website



Facebook

5. Click [Start Bind]:
 - When the RF standard selection is AFHDS 3 2 way, the receiver LED is solid on, indicating the bind is successful. The transmitter will automatically exit the bind interface.
 - When the RF standard selection is AFHDS 3 1 way, the receiver LED flashes slowly, after the receiver LED becomes slow flashing, then put the transmitter to exit the binding state. At this time, the receiver LED is solid on indicating the binding is successful.
6. The bind is successful. Take off the power cord from the receiver.
7. Reconnect the power cord to the receiver. Check whether the servo is working properly. If a bind is required again, repeat the above steps.
 - If you want to use the dual receiver mode, click the check box on the right side of [Dual Receiver Mode]. The icon will change to and then the transmitter will enter dual receiver mode. After selection, bind the transmitter with the primary receiver and the secondary receiver in turn.

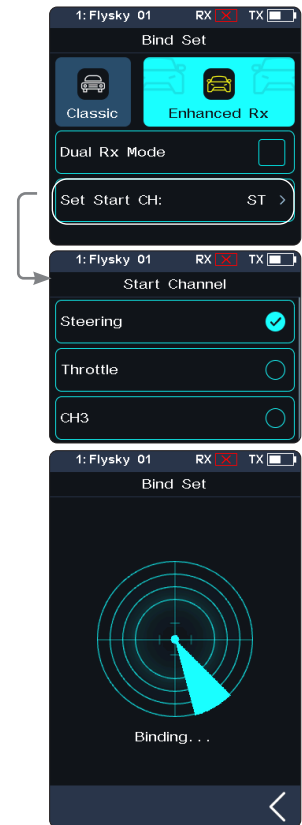

• This binding procedure only applies to the Noble Pro transmitter and FGr4P/FGr8B receivers. Different receivers have different binding procedures. Please refer to our official website for more information and relevant user manuals.

• Our products are updated regularly, check on website for the latest updates and features.

Two Receivers Mode

For a standard car and boat model, the FGr8B receiver with 8 channels can satisfy the requirements.

This function can be used when you have two models that you want to control with the same transmitter.

For some models with more complex functions, such as excavators (loaders) with extended fuel lines, dump trucks with hydraulic booms, etc., the FGr8B receiver with 8 channels is not enough. It needs to be determined according to the number of functions. You can assign two receivers to the vehicle base function and the boom base function, and then switch between them with Noble Pro's [Dual Rx Mode] function. Noble Pro has only 18 output channels. When the number of combined dual receiver channels exceeds the number of channels pre-selected by the transmitter, extra channels cannot be used.

- Disconnecting one receiver in dual receiver mode does not affect the connection of the other receiver.

Note: When there is a stable two-way communication established between the transmitter and the receiver, the transmitter recognizes the receiver as a non FLYSKY receiver, the system will prompt and interrupt the communication.

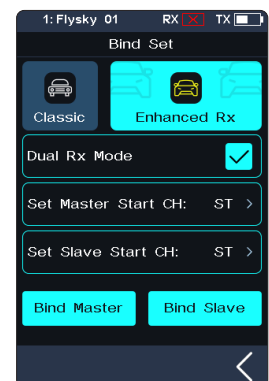

7.2 Steering Force

This function is used to adjust the amount of steering force when the servo is steered. This function can be set when the transmitter RF Setting is set to [Mini-Z(FHSS)]. It will be hidden when the RF is set to other standards.

Setup:

Click "+" or "-" to change the percentage of steering force. The adjustment range is 0-100%, and the adjustment step is 1%. It also can be adjusted by assigning TR/VR key or knob in [ASSIGN] function.

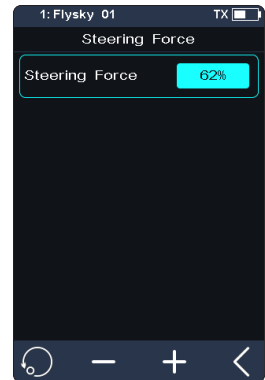

7.3 Gyro Gain

This function is used to adjust the gain of the gyroscope on the receiver. This function can be set when the transmitter RF Setting is set to [Mini-Z(FHSS)]. It will be hidden when the RF is set to other standards.

Setup:

Click "+" or "-" to change the percentage of gyroscope gain. The adjustment range is 0-100%, and the adjustment step is 1%. It also can be adjusted by assigning TR/VR key or knob in [ASSIGN] function.

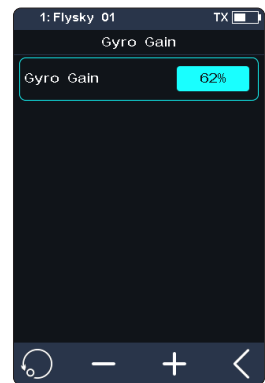

7.4 Steering ICS This function is available for version 1.0.3 or later.

This function is used to set the parameters of the gyroscope mixing direction channel of the vehicle control base board.

This function can be set when the transmitter RF Setting is set to [Mini-Z(EVO2)]. It will be hidden when the RF is set to other standards.

Setup:

1. Tap the function item you want to set.
2. Click "+" or "-" to change the option or value.



微信公众号



Bilibili



Website



Facebook

7.5 Throttle ICS This function is available for version 1.0.3 or later.

This function is used to set the parameters of the gyroscope mixing steering channel of the vehicle control base board.

This function can be set when the transmitter RF Setting is set to [Mini-Z(EVO2)]. It will be hidden when the RF is set to other standards.

Setup:

1. Tap the function item you want to set.
 - For function [Reverse Limit] and [Brushless], tap it repeatedly to select between OFF and ON.
2. Click "+" or "-" to change the option or value for other functions.



7.6 Select Receiver This function is available for version 1.0.3 or later.

This function is used to update the firmware of Mini-Z RF3 V2 receiver.

This function will appear when the transmitter RF Setting is set to [Mini-Z(EVO2)]. And it will be hidden when the RF is set to other standards.

Setup:

1. Tap [Update Receiver] to enter.
2. Click [Update] to start.

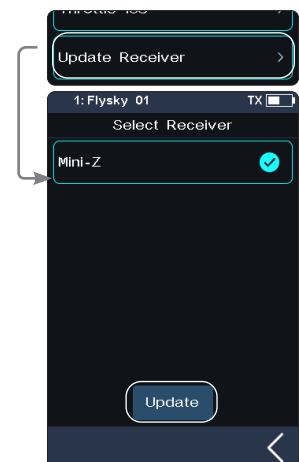

7.7 RX Interface Protocol

This function is used to set the receiver output mode.

Classic Version Receiver Interface Protocol

When the adapted receiver is FGr4, FGr4S, FGr4P, FTr4, FTr10 and FTr16S, The output protocols of [CH1 interface] and [Serial port protocol] can be set respectively. [CH1 Interface] can be set to PWM or PPM. [Serial] can be set to i-BUS or S.BUS (please refer to [7.10 i-BUS Setting] for specific i-BUS setting).



CH1 Interface

Sets the output protocol of CH1.

Setup:

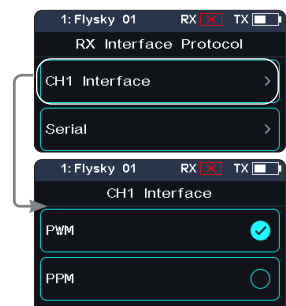
1. Click [CH1 Interface].





- Tap  on the right side of the corresponding protocol. Click  to return to the previous level interface.

Serial

Sets the output protocol of serial interface.

Setup:

- Click [Serial].
- Tap  on the right side of the corresponding protocol. Click  to return to the previous level interface.

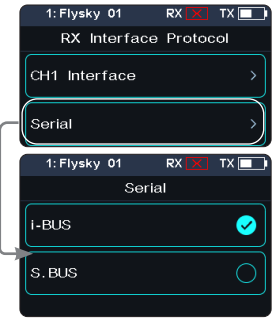

Enhanced Version Receiver Interface Protocol

When the adapted receiver is another enhanced version receiver, the output protocol of the receiver NPA/NPB/NPC/NPD interface can be set.

In dual receiver mode, the interface protocols of the Master and the Slave receiver can be set respectively.

For the NPA/NPB/NPC/NPD interface of the Master receiver, the output modes include PWM, PPM, S.BUS, i-BUS in, i-BUS out and i-BUS2.

- When the NPA interface is set to PPM output, the other interfaces support PWM, S.BUS, i-BUS in, i-BUS out and i-BUS2 signal output.

The output modes for the Slave receiver NPA/NPB/NPC/NPD interface are PWM, PPM, S.BUS, i-BUS out and i-BUS2.



- When the RX i-BUS 2 HUB simulator function is disabled, you can select only once for PPM, S.BUS, i-BUS in, i-BUS out and i-BUS 2 signals in multiple new ports. For example, if NPA is set to i-BUS out, NPD/NPC/NPB/NPA should not be set to i-BUS out.
- The simultaneous conflict of i-BUS and i-BUS 2 transmission information is prohibited. When any new port is set to i-BUS out or i-BUS in, other new ports should not be set to i-BUS 2. If any new port is set to i-BUS 2, other new ports should not be set to i-BUS out or i-BUS in.
- When the RX i-BUS 2 HUB simulator function is enabled, multiple new ports can be set to one type of signal, such as NPA ~ PWM, NPB ~ PWM, NPC ~ i-BUS 2 HUB, and NPD ~ i-BUS 2 HUB.

[i-BUS in]: Connects to i-BUS sensor.

[i-BUS out]: Connects to i-BUS extension receiver or other i-BUS signal recognition device.

[i-BUS2]: When the receiver i-BUS2 HUB simulator function is disabled, only 1 i-BUS2 signal output is allowed. When the receiver i-BUS2 HUB simulator function is enabled, 1-4 i-BUS2 signal outputs can be selected.

Setup:

- Click [Receiver Interface Protocol]. When the bind setting is in dual receiver mode, select the Master receiver or the Slave receiver to enter the submenu.
- Select [NPA] or other options. Click  on the right side of the corresponding protocol. Then click  to return to the previous level interface.

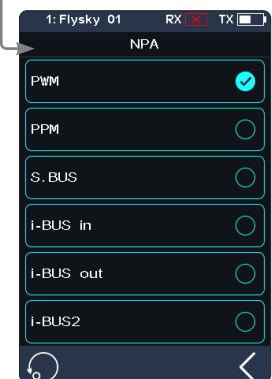
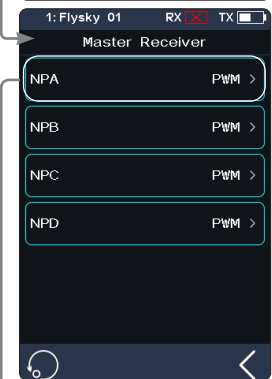

微信公众号



Bilibili



Website



Facebook

7.8 Failsafe

The Failsafe function can be set in the following three ways:



- Set to disable the signal output of i-BUS-out and PPM protocol interfaces in case of out-of-control, i.e., no output at i-BUS-out & PPM interfaces in case of losing control.
- Set failsafe values channel by channel: Free/Fixed value/Hold.
- [Set all fixed value channels], namely, you can set the output values of all channels controlled by a control to the current value, and this value will be output when the system is losing control.



Failsafe Test Function

Used to simulate the out-of-control case, when the model is out-of-control, the transmitter will shut down the RF, then the model will enter the out-of-control state. All channels will output according to failsafe settings.

Setup:

1. Tap , a popup window comes along with it as shown. Press and hold  over 1S, then the system turns off RF. And the receiver output channel value according to failsafesettings.
2. Release , the RF is on and the connection is restored.

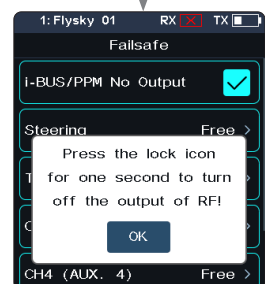

i-BUS&PPM No Output

This function is for i-BUS and PPM signals. After [i-BUS/PPM No Output] is enabled, regardless of the setting of the failsafe, these two types of failsafe signals are always no output. If the function is disabled, after losing control, you can set by channel: set to fixed value or keep the last output value. By default, this function is enabled.

Tap at the right side of [[i-BUS/PPM No Output], the check box next to right of the option is not ticked, it indicates that the function is disabled.

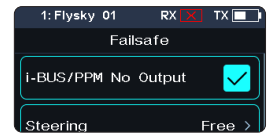

Set A Separate Channel

Used to set the output signal states of channels respectively: Free means that there is no output in case of out-of-control; Hold means the last channel value is kept in case of out-of-control; Fixed Value means that you can set the failsafe output value by moving the control, then the value set will output in case of out-of-control.

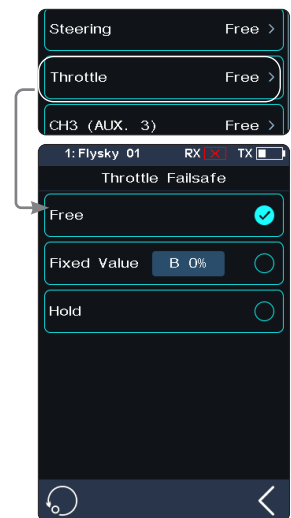

Set All Fixed Value Channels

Can be used to set the output value of all channels controlled by a control that has been set to a fixed value after out-ofcontrol.

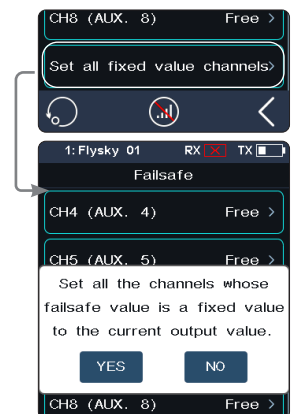

Note: Gas powered models are slightly different when it comes to failsafe setup.

Gas powered: It is recommended to set failsafe for the vehicle's brake, that is, set the throttle channel output value of the vehicle as if braking.

Battery Powered: 1. It is recommended that the failsafe is set so that it stops the vehicle, that is, set the throttle channel value of the vehicle in a neutral position.

2. It is also possible to set the failsafe to auto brake in case of signal loss.

- Some ESCs also use breaking as reverse, make sure to check this with your model.



微信公众号



Bilibili



Website



Facebook

7.9 Servos Frequency

This function is used to select the frequency of channel data PWM signals. The function includes analog servo (95 Hz), digital servo (380 Hz), and custom frequency. You can select or set the correct output frequency value according to the servo used. By default, the system adopts the digital servo. The custom frequency adjustment range is 50-400 Hz.

The servos frequency varies slightly with the connected receivers.

For the Classic Version Receiver

1. Click [Servos Frequency].
2. Click on the right side of the corresponding function. Click to return to the previous level interface.
 - If the transmitter RF Setting is set to [AFHDS 3 1 way], modify the servo response speed and then press the exit button. The system prompts "It takes effect after bind or re-bind. Are you sure you want to bind?"
3. If you choose [Custom], click the "+" or "-" to adjust the frequency.

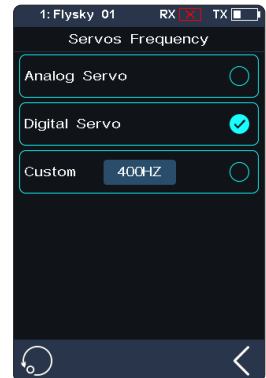

For the Enhanced Version Receiver

[SR]: One of the specifications in the servo frequency (PWM frequency is 833 Hz).

[SFR]: One of the specifications in the servo frequency (PWM frequency is 1000 Hz).

Note: the conventional servo response speed (PWM frequency) is 50-400 Hz. The delay of the whole system will be greatly improved when SR and SFR are selected. Make sure that the adapted servo supports the corresponding frequency. Otherwise, it may cause the servo not to work properly or even damage the servo.

Set A Channel

Sets PWM frequency for a channel.

[Synchronized with RF]: The digital signal of low frequency is synchronized with the digital signal of radio frequency.

Setup:

1. Click [Steering Digital Servo] or other options to enter the function setting interface.
2. Click on the right side of the corresponding servo frequency according to the actual state of the adapted receiver. Click to return to the previous level interface.
 - Click the check box on the right of [Synchronized with RF]. The icon will change to . The servo frequency of this function will be synchronized to RF after it is checked.
3. If you choose [Custom], click "+" or "-" to adjust the frequency value.



Set All Channel

Sets PWM frequency for all channels.



7.10 i-BUS2 Setup

This function is used to set up the i-BUS2 devices. For details, see 6.26 i-BUS2 section.

7.11 i-BUS Setup

This function is used to set up the i-BUS expansion module.

The i-BUS function is mainly used for servo expansion. If a cable is too short or the number of servos exceeds the outputs for the receiver, the i-BUS module provides a convenient option for expansion. When using the i-BUS receiver, make sure that it is powered separately to ensure that servos have sufficient power.

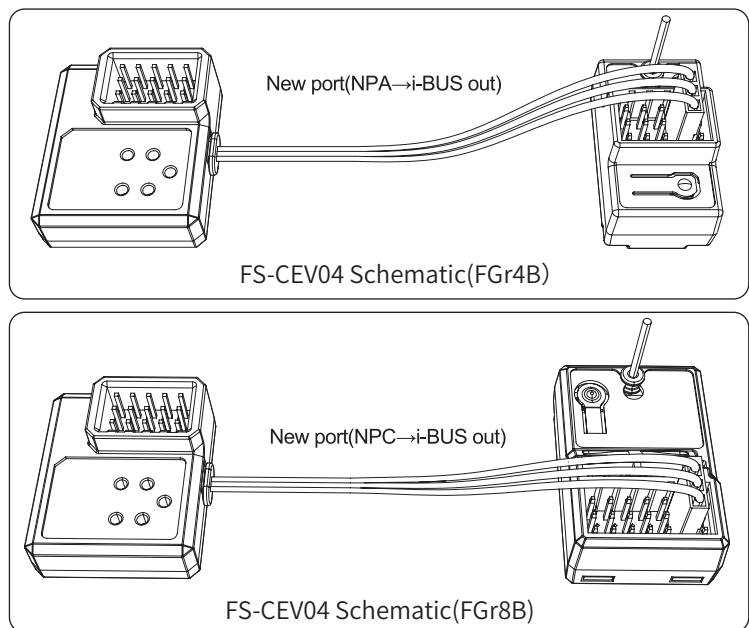

Setup:

1. Turn on the transmitter and enter [MODEL], then tap [Channel Number Definition], and select the number of channels to be set (optional 2、4、6、8、10、12、18 channels, the system defaults to 8 channels).
2. Go to [RX SET] and bind the transmitter and receiver.
3. Tap [RX Interface Protocol] and select [i-BUS out].
4. Connect the FS-CEV04 to the FGr8B/FGr4B receivers' [i-BUS out] interfaces.
5. Touch [i-BUS Setup] and select the channel to be assigned, (touch "channel X", the system display a "Assigning channel X, Press the corresponding key on the serial BUS receiver to assign"). Use the appropriate tool to press the K1, K2, K3 or K4 button on the FS-CEV04 to assign the selected channel to C1, C2, C3 or C4. If successful, the transmitter will display: "Channel assigned to interface X / Servo X".
6. Connect the servo to the corresponding port and check if it is working as expected.
7. Repeat the above steps as needed.

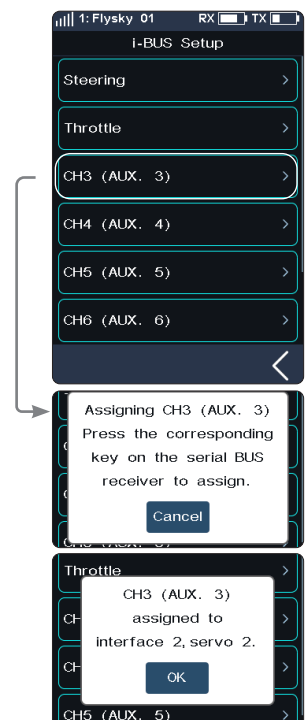

7.12 Config PWM Converter

This function allows you to configure the corresponding receiver to a PWM converter. After the setting is successful, the receiver is used as a PWM converter, and the interfaces output PWM signals.

Note: This function is not available for all receivers. For the classic receiver, only the FGr4 and FTr10 receivers are available.

[i-BUS To PWM]: This feature is adapted to classic version or enhanced version receivers to config as PWM converter. For the classic version receivers, after it is set as a PWM converter, its SENS interface is connected to the interface of the receiver outputting i-BUS or i-BUS out. For the enhanced version receivers, after it is set as a PWM converter, its NPA interface is connected.

[i-BUS2 To PWM]: This feature is adapted to enhanced version receivers to config as PWM converter. After it is set as a PWM converter, its NPA interface is connected the interface of the receiver outputting i-BUS2. And you can set related parameters through [i-BUS2], refer to 6.26 i-BUS2 section.

i-BUS To PWM

Setup:

1. Enter the interface of Config PWM Converter and tap [i-BUS To PWM].
2. Tap [Start Channel] to enter the setting interface, then set the start channel for the PWM converter.
 - For example, if the receiver has 4 channels, and since one of channels is used as an extension interface, then the start channel of the PWM converter can be set to "4".
3. Tap [Servos Frequency Digital] to enter the setting interface to set the servo frequency for the PWM converter. Then click [Start Config], the configuring interface comes along.
4. Put the receiver to enter the bind mode, after the LED status of the receiver changes from fast flash to two-flash-one-off, it indicates the configuration is finished. Then click  to return.

If you set the receiver as a i-BUS2 PWM converter, there are not need to set [Start Channel] and [Servos Frequency].



7.13 RSSI Output Setup

Through this function, you can select a channel to output the signal strength value of the receiver. After the function is enabled, the selected channel does not perform the output of transmitter's corresponding channel function, but outputs the receiver's signal strength value. This feature is necessary for FPV players with autopilot. We recommend you to select the CH14 or any auxiliary channel. You can make corresponding adaptations in the settings to view the RSSI information on FPV glasses.

Setup:

1. Tap the check box on the right side of [ON] to enable this function.
2. Click [Output Channel] to enter, and tap on the right side of the corresponding channel. Click to return to the previous level interface.

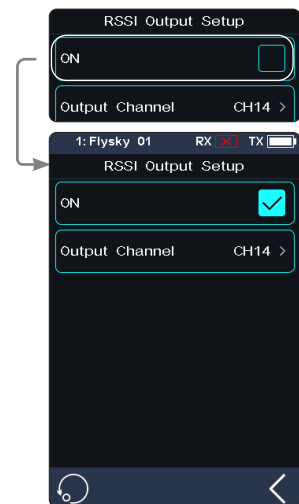

7.14 RX Battery Monitor

This function is used to detect the voltage status of the receiver or corresponding battery.

Set the high and low battery voltages according to the actual usage of the receiver battery and the remaining battery level displayed through the icon in the upper right corner of the interface. The transmitter will promptly send an alarm according to battery conditions.

When the receiver or sensor battery voltage is lower than the [Alarm voltage] alarm value, the transmitter will report "The receiver voltage is low".

[Sensor]: The voltage of the Voltage sensor is used as the voltage of the receiver. [Internal Voltage], [External Sensor Voltage], [BVD Voltage] or [ESC Power] can be selected. After selection, it can be displayed and alarmed through the transmitter.

Setup:

1. Tap [Rx Battery Monitor] to enter the setting interface.
2. Click [Sensor] to enter and select an internal or external sensor.
3. When set the Sensor as the voltage sensor, then set the [Low voltage], [Alarm voltage], and [High voltage] values; When set the Sensor as the ESC Power, [Alarm Power] and [Full Power] can be set.
 - [Low Voltage]: It is corresponding to receiver battery level which is 0%; [High Voltage]: It is corresponding to receiver battery level which is 100%.
 - [Alarm Power]: It is corresponding to power in case of the alarm; [Full Power]: It is corresponding to ESC battery level which is 100%.

Notes:

1. [ESC Power] is only applicable for Hobbywing XERUN AXE R2 ESC.
2. When multiple XERUN AXE R2 ESCs are connected, the setting is for the first ESC connected.
3. [Internal Voltage] is corresponding to the voltage of the receiver; [External Sensor Voltage] is corresponding to the voltage detected by the FS-CVT01 sensor; [BVD Voltage] is corresponding to the voltage detected through BVD function; [ESC Power] is corresponding to the power of XERUN AXE R2 ESC.

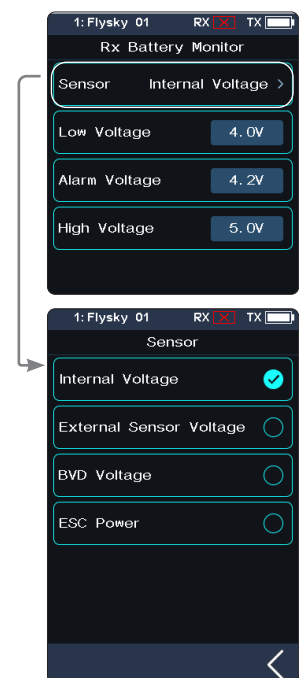

微信公众号



Bilibili



Website



Facebook

7.15 Range Test

This function is used to test whether wireless communication between the transmitter and the receiver is normal.

As the actual remote control distance between transmitter and receiver is far, it is hard to test whether the radio frequency is normal by controlling a distance of several hundred meters between the transmitter and receiver in practice. Theoretically, the remote control distance in this function will be reduced to 30-40 meters. So, you can test whether wireless communication between the transmitter and the receiver is normal at a close distance when the function is enabled. This can save testing time.

Setup:

1. Make sure the transmitter and receiver are bound.
2. Enter the [Range Test] menu and press the SW1-R button.
3. One person stands in place with the model in hand, and the other person holds the transmitter and gradually moves away to 30-40 meters and walks around with this distance as a radius centered on this model.
 - Please make sure the transmitter is installed with phone holder, with use of the standard version firmware.
 - Make sure that the transmitter antenna is unobstructed and that there are no objects or sources of interference between the transmitter and the receiver.
4. Check the RSSI on the transmitter. If the signal strength is high and stable, it means that the radio frequency of this system works normally.



7.16 BVD Voltage Calibration

The BVD voltage is calibrated before delivery from the factory. This function can be used when there is an excessive deviation between the detected and actual voltages. The BVD voltage value can be adjusted from 0V to 100 V.

Note: This function is not available for classic version receivers. Pay attention to correctly connect the BVD cable to the anode and cathode terminals of the battery. The connection diagram is as follows.

Setup:

Connect the BVD detection line correctly before setting, and then perform calibration.

Note: please refer to the voltage value of multimeter for calibration.

1. Click [BVD Voltage Calibration] to enter the function setting interface.
2. Click the "+" or "-" to change the battery voltage value as needed.
3. Click [Calibration]. After successful calibration, click [Yes] in the pop-up window reminder.

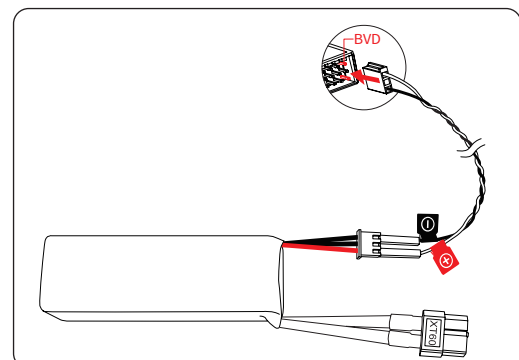
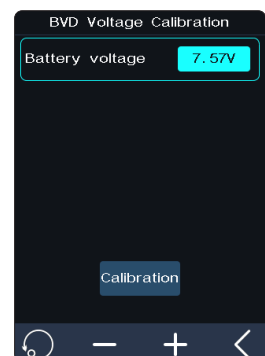

7.17 Low Signal Alarm

This function is used to enable or disable the low signal alarm function.

[Low Signal Alarm]: If checked, the system will alarm automatically if the signal strength of the receiver is lower than 30.



7.18 Update Receiver

After the transmitter has updated the firmware, and at the time, it can not bind with the receiver, then the receiver firmware is needed to be updated.

Setup:

Touch [Update Receiver]:

- Some receivers such as GMr need to be updated with "Flysky Assistant".
- If the transmitter has successfully coded and the connection is established, if the receiver is the latest version, a pop-up prompt will appear [The current version is the new version, no upgrade is required!]. If the transmitter is an old version, a pop-up prompt [Are you sure to update the receiver?]. Click [OK] to update the receiver;
- If the receiver and the transmitter are not connected, then enter the receiver selection interface, check the receiver to be connected and pop up a prompt [Please connect XX or enable XX enter the mandatory update mode]. Click [OK]!



After entering the update state, When the progress is 100%, it indicates the update is successful.

Note: You must update the transmitter's firmware before updating the receiver's firmware.

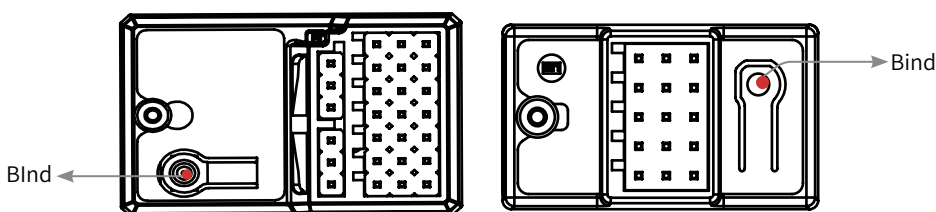
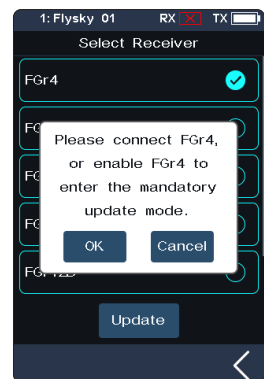

The steps of the forced update of the receiver are as follows:

1. Press and hold the bind key on the receiver over ten seconds while powering on the receiver, then release the bind key after the receiver LED works in flash-three-one-off state repeatedly.
2. Power on the transmitter and select [Update Receiver]. Click on the right side of the corresponding receiver. Select "OK" on the pop-up box. Click [Update] to enter the update state.
3. When the update has finished, the receiver LED flashes slowly.



微信公众号



Bilibili



Website



Facebook

8. SYSTEM

8.1 Theme This function is available for version 1.0.3 or later.

It is used to set the overall color style of the system, with 4 options.

Setup:

1. Touch [Theme] to enter the menu.
2. Select a theme as your desired.
3. Touch  to save.

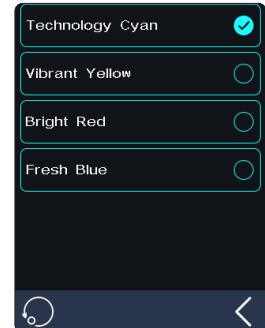

8.2 Wallpaper This function is available for version 1.0.3 or later.

It is used to set the wallpaper of home screen and main menu.

[Home Screen Wallpaper]: Sets the wallpaper of home screen.

[Main Menu Wallpaper]: Sets the wallpaper of the main menu.

Wallpaper preview: Wallpaper preview: To preview the wallpaper in full screen and hide the option, click the area outside the corresponding function option. Click again to exit the preview.

Setup:

1. Touch [Wallpaper] to enter the menu.
2. Select a wallpaper as your desired.
3. Touch  to save.

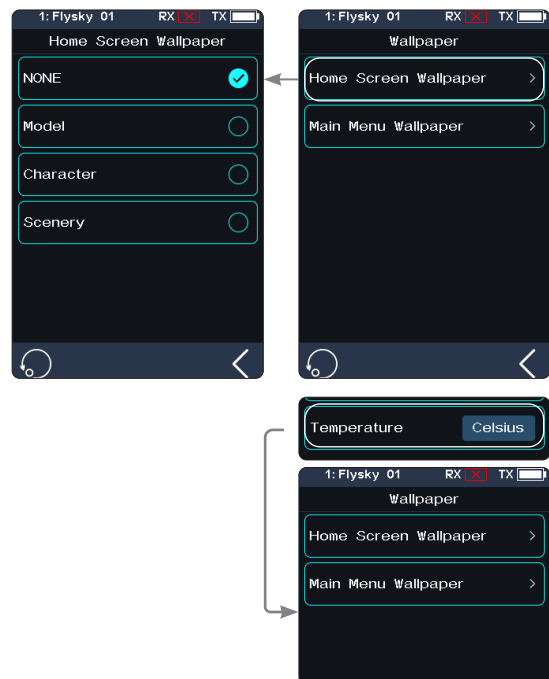

8.3 Units

Choose what units to use for length and temperature.

[Length]: Select between metric and imperial system. The default is Metric.

[Temperature]: It can be selected in Celsius and Fahrenheit. The default is Celsius.

The box highlighted in light green is the currently selected setting.

Setup:

1. Touch "unit" to enter the menu.
2. Select a unit from the list.
3. Touch  to return to the previous menu.

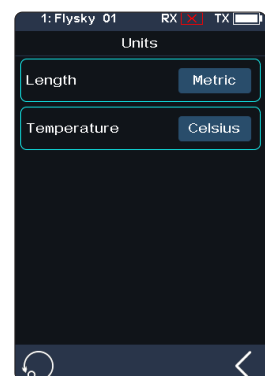

8.4 Backlight Adjustment

This function controls the backlight brightness.

Note: Turning the brightness up will use more power and as such will lead to reduced battery life.

[Backlight Timeout]: Select the delay time. That is, when there is no action, the screen is reduced to a minimum brightness state after the corresponding backlight delay time, with options of 5 seconds, 10 seconds, 30 seconds, 1 minute, 2 minutes, 5 minutes, 10 minutes of backlight delay and normal light.

[Max Backlight]: The adjustment range is 10%-100%. Click the "+" or "-" icon to change the percentage as required.

[Mini Backlight]: The adjustment range is 0% -50% (the screen is not bright at 0%). The adjustment method is the same as above.

Then, click  to return to save.

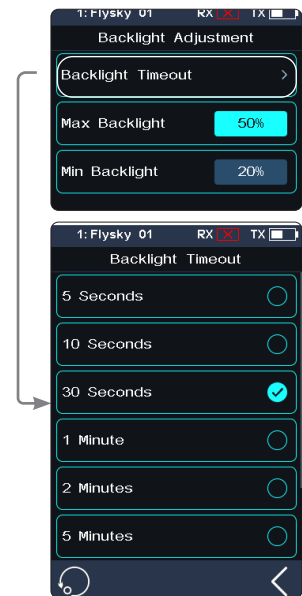

8.5 Sound

This function is used to turn on or off sound of different function, including system sound, alarm sound, power-on/power-off sounds, and etc.

[Volume]: To set the volume.

Tap [Volume], then select the desired volume from the list. Touch  to return to the previous menu, and save it.

[System Sound]: To turn on or off system sound.

Click the option box on the right side of the interface. The icon will change to , indicating that the system sound is enabled.

[Alarm Sound]: To turn on or off alarm sound.

[Trim Sound]: To turn on or off power on/off sound.

[Timer Sound]: To turn on or off timer related prompt sound.

[Sensor Sound]: To turn on or off sensor alarm related prompt sound.

[Menu Operation Sound]: To turn on or off prompt sound when a touch screen operation takes effect.

[Alarm sound] and [Power On/Off sound] are the same as above.

Note: For details about how to set other functions, refer to system sound settings.



微信公众号



Bilibili



Website



Facebook

8.6 Vibration

This function is used to enable or disable the system vibration and alarm vibration function and adjust intensity of vibration levels.

[Vibrate Level]: To set the intensity of vibration level.

Tap "Vibrate Level" then select the desired strength from the list. Touch  to save.

[System Vibrate]: To turn on or off system vibration.

Tap the box at the right of "System Vibrate". If there is a check in the box, indicating the function is enabled.

[Alarm Vibrate]: To turn on or off alarm vibration.

[Power on/off Vibrate]: To turn on or off power on/off vibration.

[Trim Vibrate]: To turn on or off the trim operation of the prompt vibration.

[Timer Vibrate]: To turn on or off timer related prompt vibrations.

[Sensor Vibrate]: To turn on or off sensor alarm related prompt vibrations.

[Menu Operation Vibrate]: To turn on or off prompt vibration when a touch screen operation takes effect.

Note: For details about how to set other functions, refer to system vibration settings.

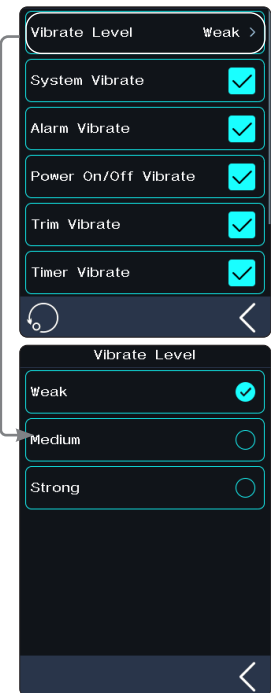

8.7 LED

The LED function can change the color of the LED strip above the power button of the transmitter, the power indicator and the brightness adjustment of the strip.

Type selection

To set the color of the LED, or to turn on or off the LED.

Setup:

1. You can choose to turn off the LED.
2. LED can be used for power indication (displaying different colors according to current battery voltage);
 - High-green
 - Medium-yellow
 - Low-red
3. Select a color from the list.

Brightness control

To set the LED brightness.

Touch the "+" or "-" icon to adjust the LED brightness. After setting, tap  to save and exit.

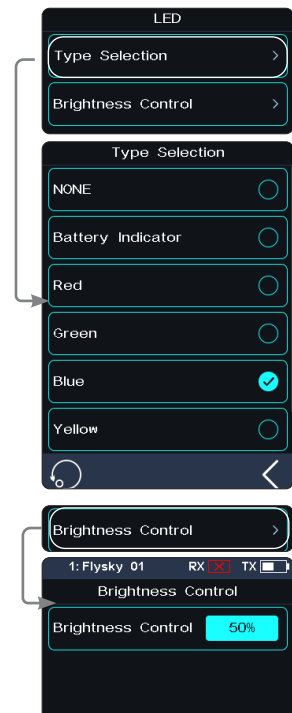

8.8 Auto Search Receiver

This function is available for version 1.0.3 or later.

When the Power on auto search receiver is checked. You can make settings to automatically switch to the model corresponding to the currently powered on receiver which has connected to the transmitter in two-way mode.

Setup:

Tap the box at the right of the [Auto Search Receiver]. If there is a check in the box, indicating that the function is active.

Note: In the auto search of receiver, you must ensure that only one model that needs to be controlled is powered on (power off other models).

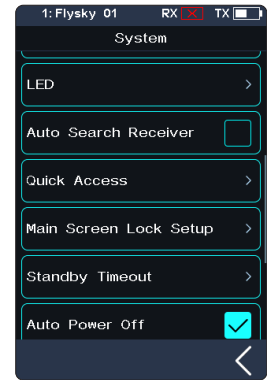

8.9 Quick Access

This function is used to set up the Up, Down, Left and Right quick sliding screen functions of the main interface. Users can customize the sliding screen interface according to their needs.

[Bottom Bar Display]: It is used to set whether to display the bottom bar of the main screen.

The [Home-Screen Quick Access] can help users find setting interfaces quickly. For example, when users want to check the lap counting time after the function is enabled in the model operations, users can use this function to enter the timer interface quickly.

Setup:

1. Enter in the function interface, click the corresponding function option to choose it; and select NONE to avoid quick operation;
2. Click , so you can save the settings.



8.10 Main Screen Lock Setup

This function is used to set the state of the transmitter after the main interface is locked.

[Touch Screen]: It can prevent the transmitter screen from being touched by mistake, because this may change the parameters that have been set.

[Touch Screen + Set]: Only channels are controllable after selection. This can avoid changing the set parameters when someone else perform operations or accidentally toggles a switch for personal reasons.

[Touch Screen+Set+CH]: After locking, all knobs, keys, or trims are unavailable. This can prevent others from modifying channel data when operating on behalf of others or changing setting parameters by accidentally toggling a switch for personal reasons.

You can click on the right of the corresponding function according to your needs. If it becomes , indicating the function is enabled.

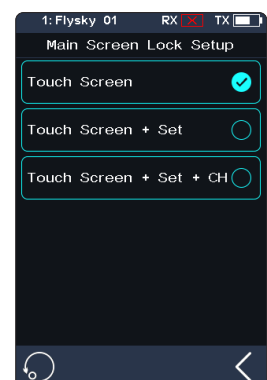

微信公众号



Bilibili



Website



Facebook

8.11 Standby Timeout

This function is used to set idle alarm intervals or no idle alarm. 5 options: [NONE], [3 Minutes], [5 Minutes], [10 Minutes] and [20 Minutes]. [NONE] means no idle alarm. The time to alert can be selected as desired. The default is 3 minutes.

Click [Standby Timeout] to enter settings, select alarm time as required, and click on the right of the option. For example, if you set the alarm time to 3 minutes, the system will give a vibration and audio alarm when the transmitter is idle for 3 minutes. You can set the on/off and volume of the sound, and the on/off and level of the vibration in [8.5 Sound] and [8.6 Vibration] in [System Settings].

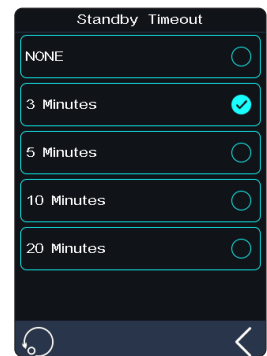

8.12 Auto Power Off

If the transmitter is powered on for a long time, the transmitter battery may be used up. If the system detects that the transmitter is not used for a long time, it will be automatically shut down.

If no operation is detected within five minutes, the system starts playing no operation sound, Auto Power Off will turn off the transmitter if no receiver is connected .

To toggle Auto Power Off touch the box to the right of the setting. If there is a check in the box, indicating that the function is active.



8.13 Stick Calibration

Stick Calibration calibrates the throttle trigger and steering wheel so that their center and outer positions are correct.

The blue bar is the channels current position and the calibrated range will be the same color like the background.

Setup:

1. Move the steering wheel and throttle trigger as far as they can go in each direction. Then release them to make them back to netrual position.
2. Touch to save and return to the previous menu.

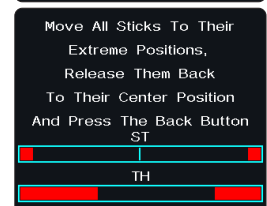
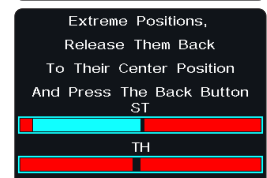
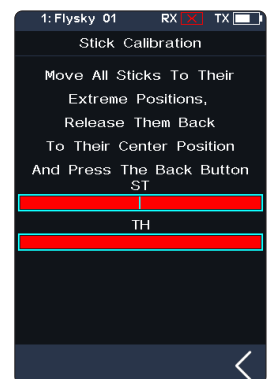

8.14 Firmware Update

Updates the transmitters firmware. In case of updating the firmware of the transmitter, use this function to put the transmitter to enter updating mode first, then upgrade the transmitter's firmware.

 WARNING	<ul style="list-style-type: none"> • Use the micro USB cable shipped with the transmitter. • Do not unplug the micro USB cable while the firmware is updating.
--	--

When the firmware is updating, never disconnect the USB cable to the transmitter.

Setup:

1. Download and open the newest official software.
2. Connect a transmitter with a computer by USB cable.
3. Touch [Firmware Update], after which "Updating the transmitter firmware may cause model data to be restored to factory default values. Are you sure?" will be displayed. Touch "Yes", to enter update mode.
4. After completing the above steps, click [Update] in the software on your computer to start the update.
5. The transmitter will power on again when the updating process is completed. Then remove the USB cable and close the firmware.

Note: The model data will be reset after the firmware update. Back up the mode data before you perform firmware updating. If the transmitter is not recognized by the official software, there may be a version problem occurred.

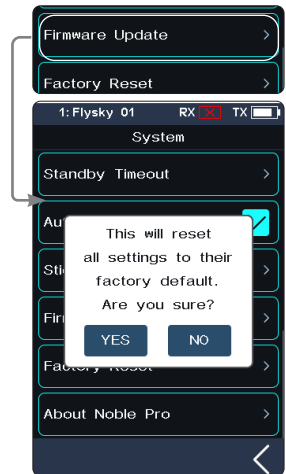

8.15 Factory Reset

Factory Reset resets all of the transmitter settings and functions back to their factory default state.

Setup:

Touch "Factory Reset", then touch "YES" when prompted.

Note: To avoid errors, do not use this function during operation.

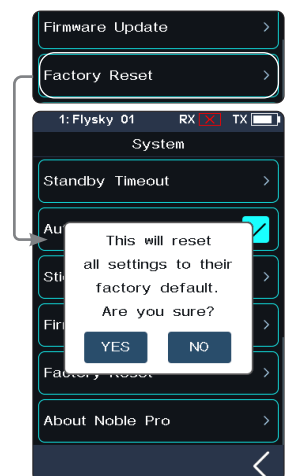

8.16 About Noble Pro

This function contains basic information such as product name, firmware version, version date, hardware and RF library version.



微信公众号



Bilibili



Website



Facebook

9. Transmitter Specifications

This chapter includes specifications for Noble Pro transmitters, FGr8B receiver and FGr4B receiver.

9.1 Transmitter Specification (NB4)

Product Model	NB4 Pro
Product Name	Noble Pro
Number Of Channels	Optional: 2 (Fast), 4, 6, 8, 10, 12 or 18.
Adaptive Models	Cars, Boats, Robots or Ironclads
RF	2.4GHz ISM
Maximum Power	< 20dBm (e.i.r.p.) (EU)
2.4GHz Protocol	A FHDS 3
Distance	> 300m (without stand)
Channel Resolution	4096
Battery	1S / (4.2V) Lithium Polymer Battery + 18650 Dual Battery
Charging Interface	Micro USB and Wireless Charging
Low Voltage Alarm	< 3.65V
Antenna Type	Single Built-in Antenna
Display	HVGA 3.5-inch TFT Color Screen, Resolution 320 * 480, LCD White Backlight, Capacitive Touch Screen
Simulator	USB Simulator
Data Interface	Micro USB
Temperature Range	-10°C ~ +60°C
Humidity Range	20% ~ 95%
Online Update	Yes
Color	Black
Dimensions	120x144x274 mm
Weight	670g (Includes the mobile phone holder.)
Certifications	CE, FCC ID:N4ZFG400, MIC,RCM



9.2 Receiver Specification (FGr4B)

Product Model	FGr4B
PWM Channels	4
RF	2.4GHz ISM
2.4GHz ISM Protocol	AFHDS 3
Adaptive Transmitters	All Transmitters With AFHDS 3 Protocol
Antenna Type	Single Antenna
Input Power	3.5-9V/DC
Data Output	PWM/PPM/i-BUS/S.BUS/i-BUS2
Temperature Range	-10°C ~ +60°C
Humidity Range	20% ~ 95%
Online Update	Yes
Dimensions	17*29*16.6mm
Weight	6.4g
Certifications	CE, FCC ID: N4ZFGR4B000

9.3 Receiver Specification (FGr8B)

Product Model	FGr8B
PWM Channels	8
RF	2.4GHz ISM
2.4GHz ISM Protocol	AFHDS 3
Adaptive Transmitters	All Transmitters With AFHDS 3 Protocol
Antenna Type	Single Antenna
Input Power	3.5-9V/DC
Data Output	PWM/PPM/i-BUS/S.BUS/i-BUS2
Temperature range	-10°C ~ +60°C
Humidity Range	20% ~ 95%
Online Update	Yes
Dimensions	35*23.3*13.3mm
Weight	9.4g
Certifications	CE, FCC ID: N4ZFGR8B



微信公众号



Bilibili



Website



Facebook

10. Package Contents

The accessories included are different in different versions, please consult your dealer for details.



11. Instructions

11.1 Brake Pad Replacement and Angle Adjustment

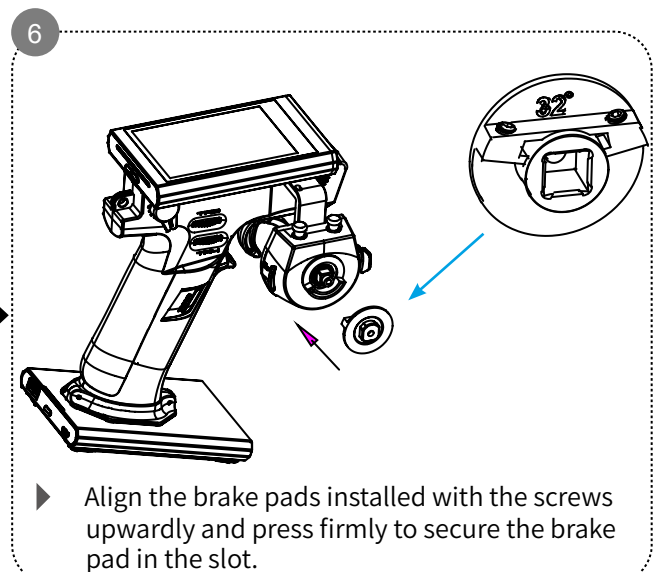
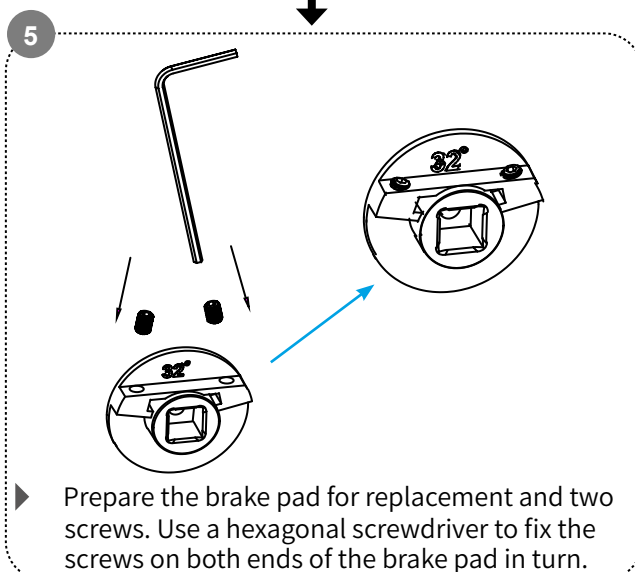
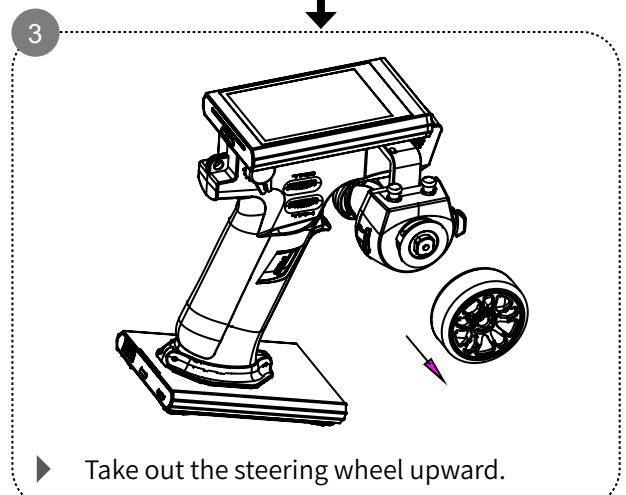
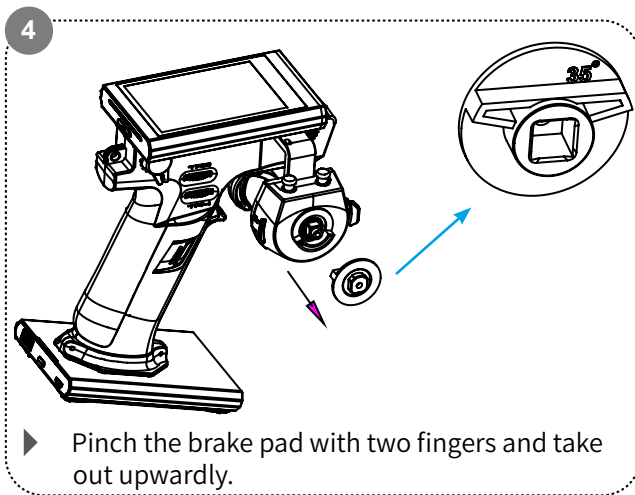
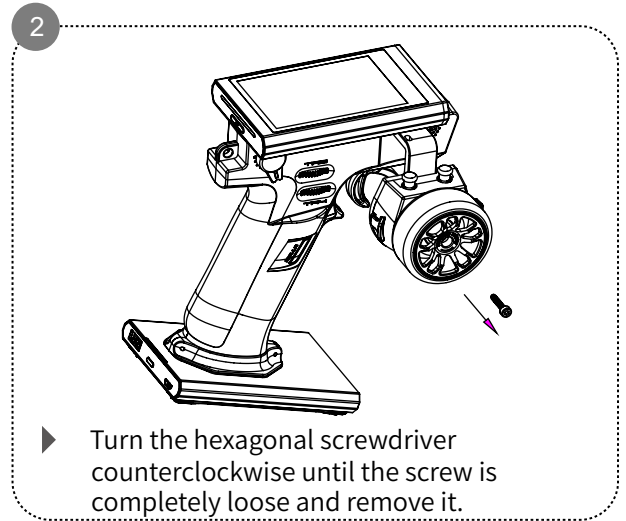
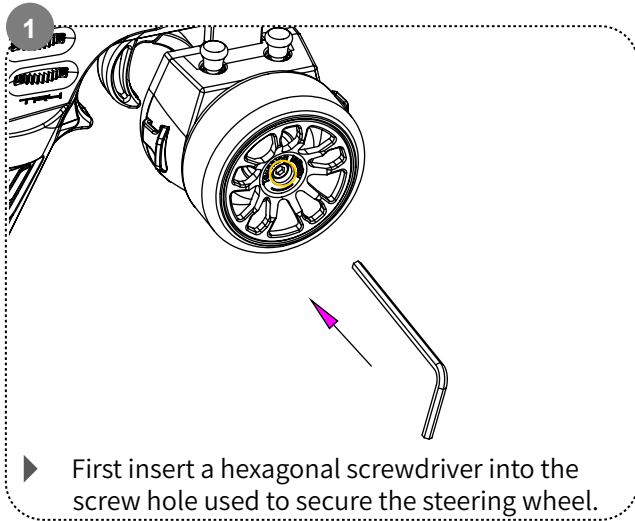

微信公众号



Bilibili



Website



Facebook

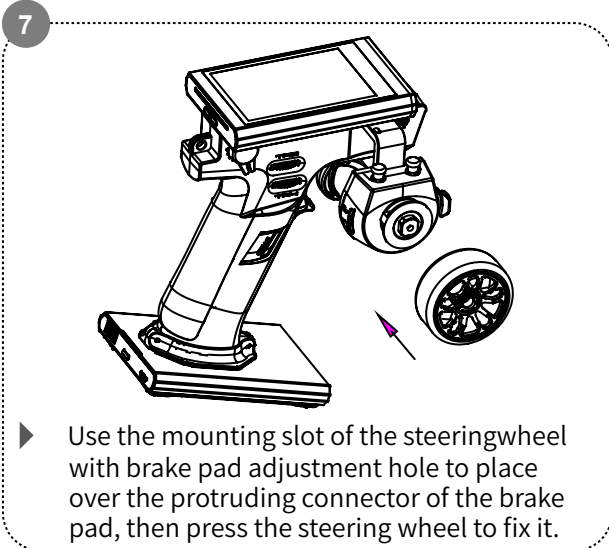

- ▶ Use the mounting slot of the steering wheel with brake pad adjustment hole to place over the protruding connector of the brake pad, then press the steering wheel to fix it.

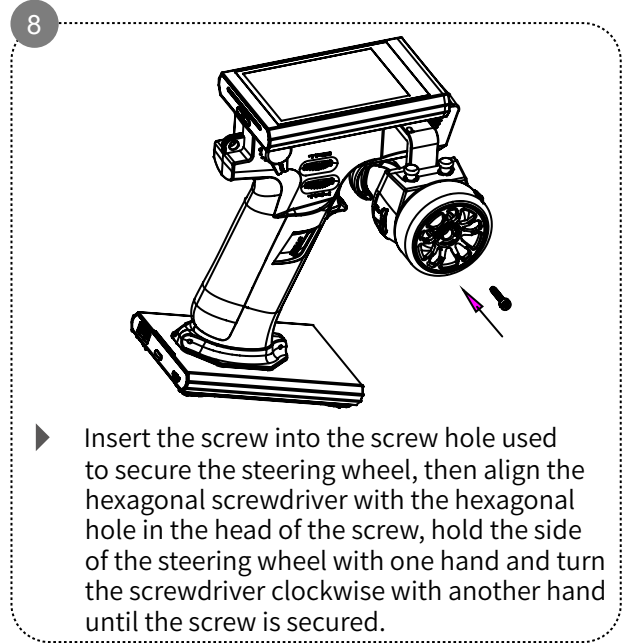

- ▶ Insert the screw into the screw hole used to secure the steering wheel, then align the hexagonal screwdriver with the hexagonal hole in the head of the screw, hold the side of the steering wheel with one hand and turn the screwdriver clockwise with another hand until the screw is secured.

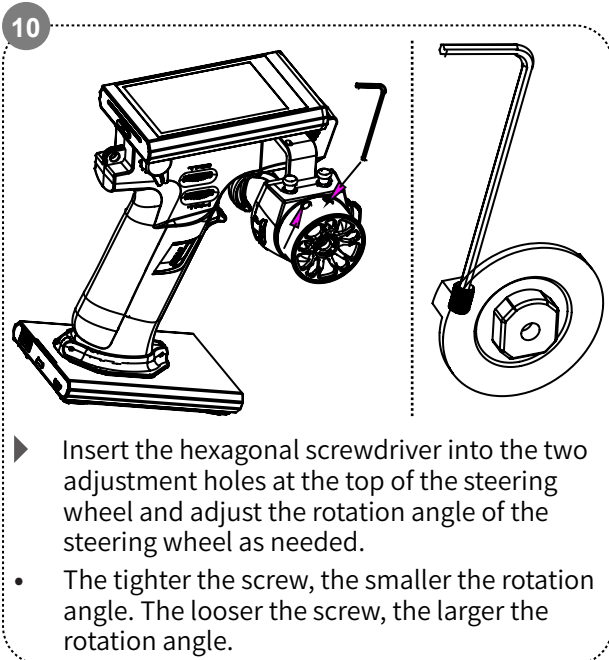

- ▶ Insert the hexagonal screwdriver into the two adjustment holes at the top of the steering wheel and adjust the rotation angle of the steering wheel as needed.
- The tighter the screw, the smaller the rotation angle. The looser the screw, the larger the rotation angle.

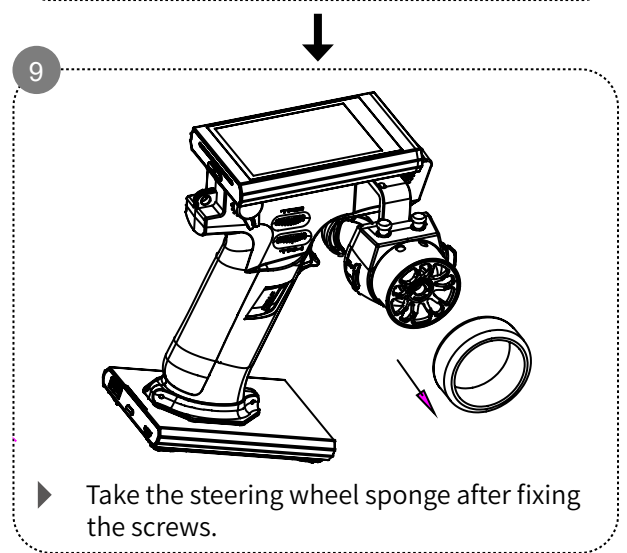

- ▶ Take the steering wheel sponge after fixing the screws.

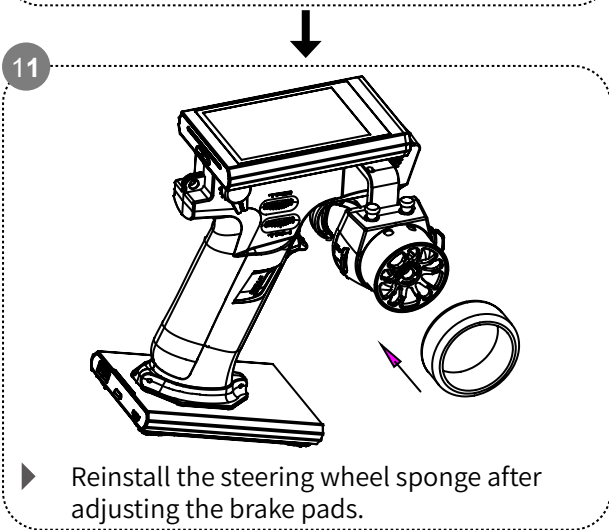

- ▶ Reinstall the steering wheel sponge after adjusting the brake pads.

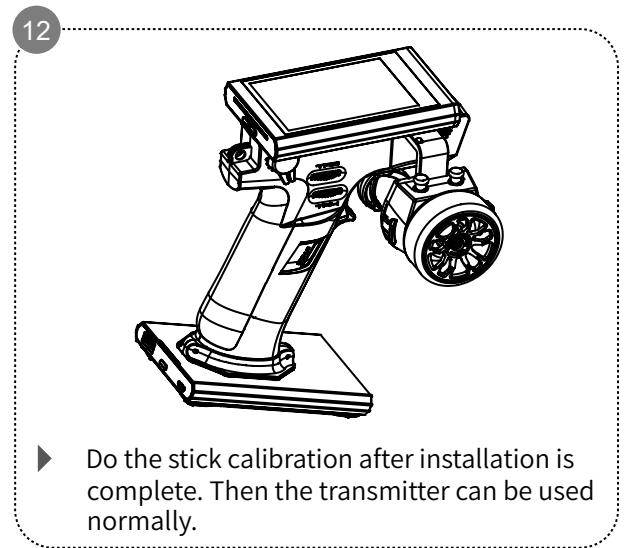

- ▶ Do the stick calibration after installation is complete. Then the transmitter can be used normally.

! Pay attention to your strength in the process of replacing the brake pads. Remember not to damage accessories. Please refer to the above steps to replace the brake pads, to ensure that the brake pads can be used normally.



11.2 Installation of Mobile Phone Holder

1

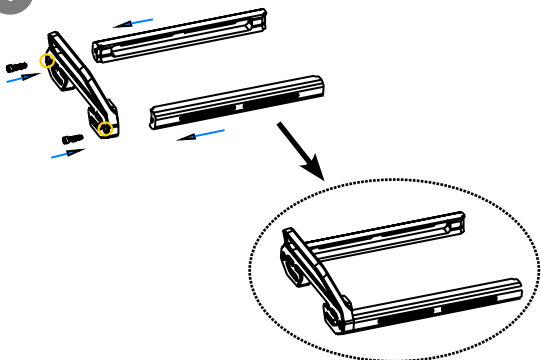

▶ Insert the screws into the screw holes on both sides of the bottom holder shell. Connect the left and right sides of the holder shell in turn. Use a hexagonal screwdriver to turn clockwise until the screws are fixed.

2

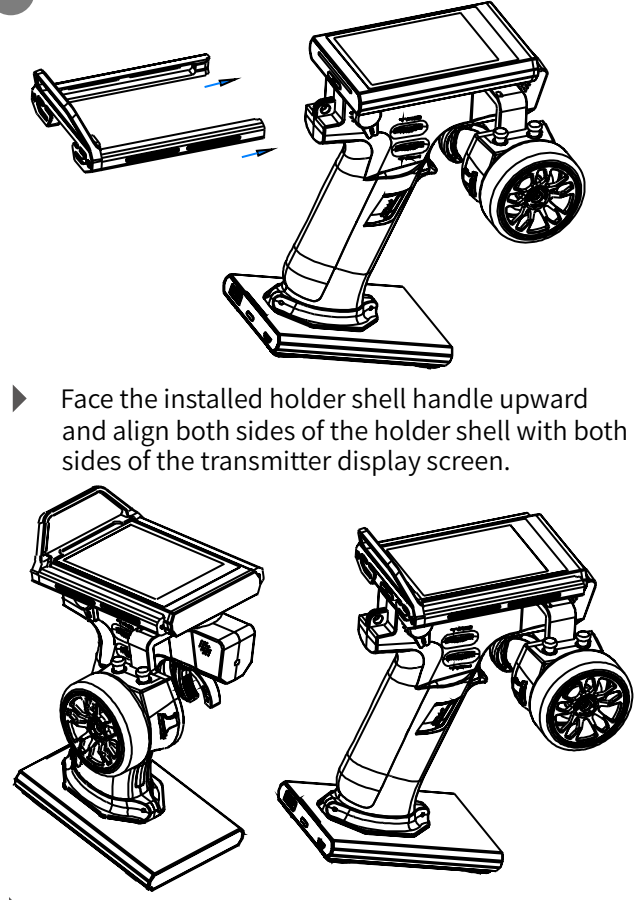

▶ Face the installed holder shell handle upward and align both sides of the holder shell with both sides of the transmitter display screen.

▶ Gently push the holder shell until both sides of the holder shell can completely cover the display screen.

3

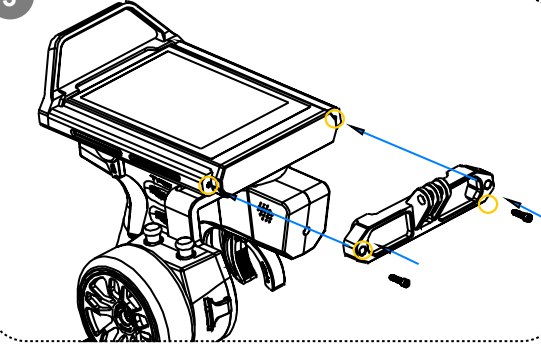

▶ Connect the holder shell with the holder connector to the top of the screen. Press the holder shells on the left and right sides by hand and insert the screws into the screw holes.

4

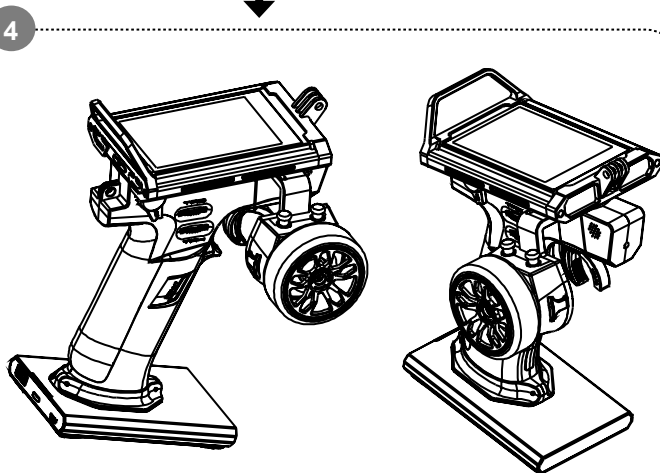

▶ Turn the screwdriver clockwise in sequence to secure the screws on the left and right sides.

5

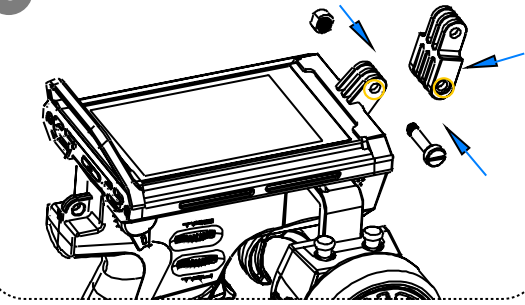

▶ Connect the holder connector to the holder head on the transmitter. Align the connection hole and insert the long screw. Set the nut on the other end of the screw and gently install the nut clockwise by hand to make it fixed.

- Choose whether to install the connector as required.
- Pay attention to the direction of the connector.



微信公众号



Bilibili



Website



Facebook

6

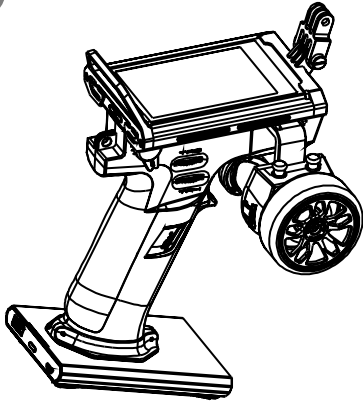

- ▶ Ensure the holder connector is installed.

7

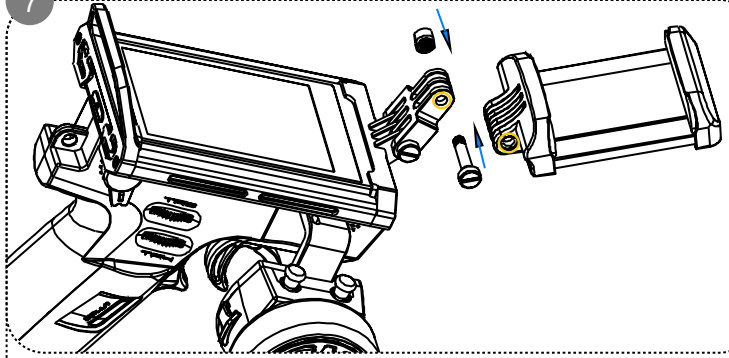

- ▶ Connect the phone holder to the other end of the holder connector. Align the connection hole and insert the long screw. Set the nut on the other end of the screw and gently install the nut clockwise by hand to make it fixed.

8

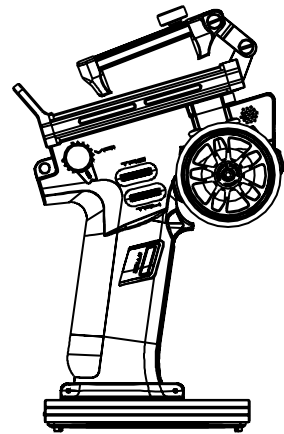
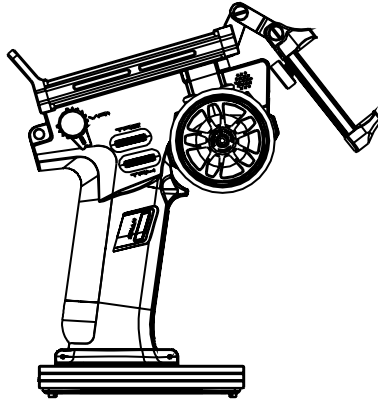
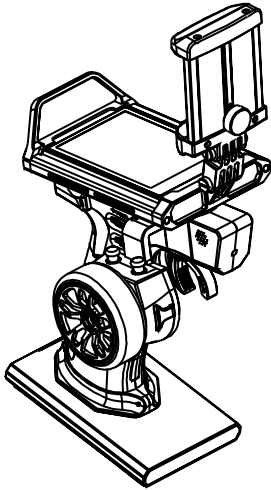

- ▶ After installation, twist the holder to ensure the holder is flexible and is firmly fixed.

11.3 Disassembly of Mobile Phone Holder

1

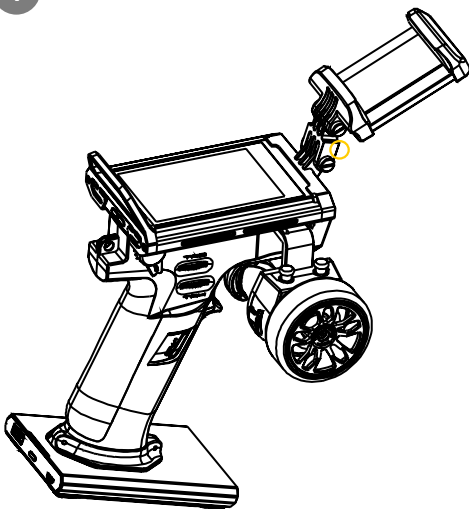

2

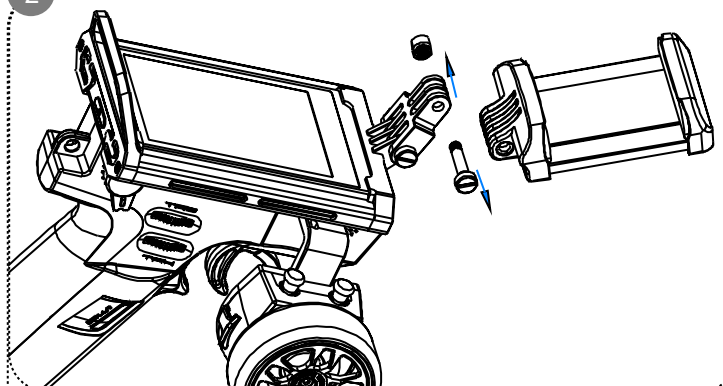

- ▶ Gently unscrew the nut connecting the holder connector and the phone holder counterclockwise by hand until the nut is completely loose. Then remove the screw, nut and holder.



3

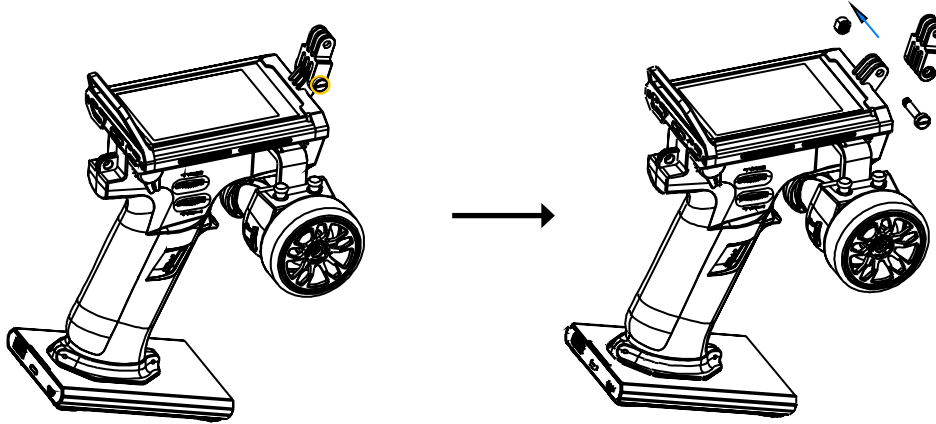

- ▶ Gently unscrew the nut connecting the holder connector and the holder shell counterclockwise by hand until the nut is completely loose. Then remove the screw, nut and holder.

4

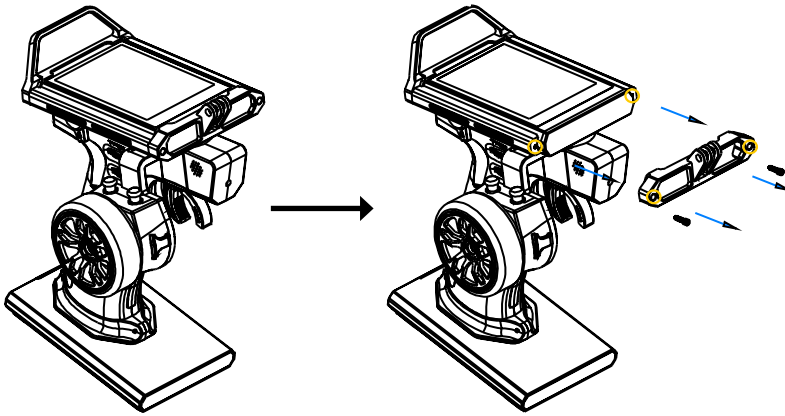

- ▶ Use a screwdriver to connect the screws on both sides of the top of the screen. Gently turn the screwdriver counterclockwise until the screws on both sides are completely loose. Remove the screws and take off the top holder shell.

5

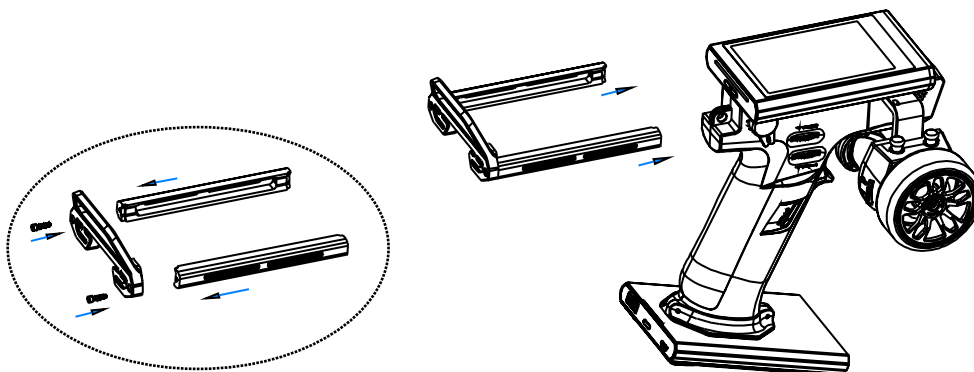

- ▶ Gently remove the remaining holder shell. Do not scratch the sides of the transmitter screen. Remove the screws on both sides of the holder shell with the handle in turn.



Pay attention to your strength in the Disassembly of Mobile Phone Holder process. Remember not to damage accessories.



微信公众号



Bilibili



Website



Facebook

11.4 Wireless Charging Function and Precautions

Wired Charging Method

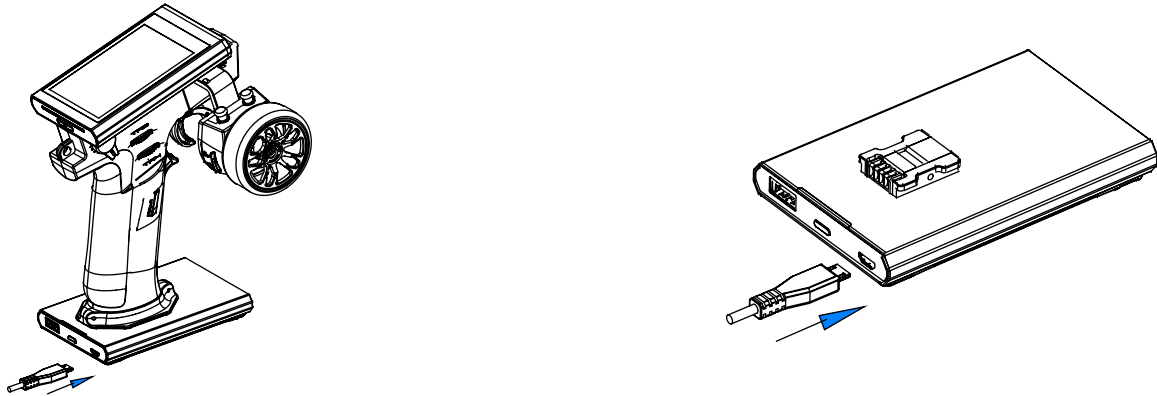

▶ The transmitter base can be charged directly by connecting the micro USB cable.

Wireless Charging Method

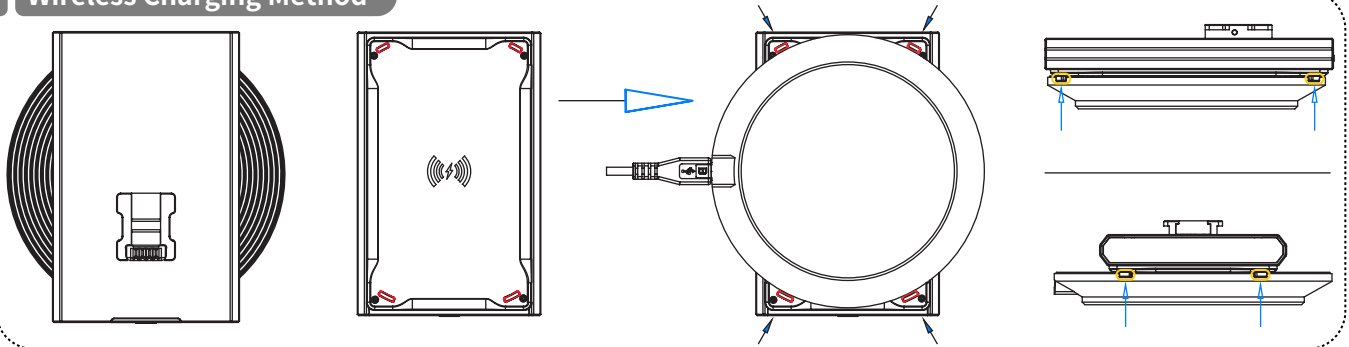

- The four bumps of the transmitter base should be connected to the base of the wireless charging transmitter.
- When the transmitter base indicator of the wireless charger is blue, it indicates the connection is successful and there is ongoing charging.
- When the transmitter base indicator of the wireless charger is red, it indicates the transmitter base is not connected, or the connection failed.
- When the transmitter base indicator of the wireless charger is blue and solid on, it indicates that the battery is fully charged. It takes about 8.5 hours to fully charge in the entire system (including the transmitter, base, and wireless charger base).

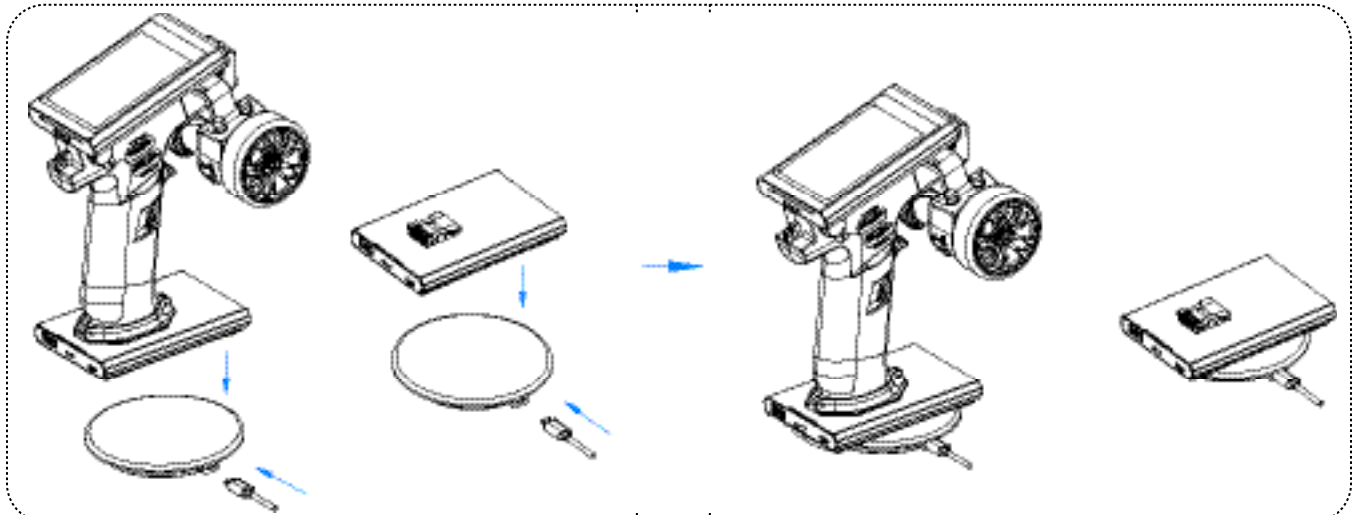

! If the transmitter base of the wireless charger is not used properly, it will lead to ineffective charging, or the charging efficiency may be affected. There are the following non-standard operations: transmitter base is not aligned with the wireless charger base, the base may be tilted, or the four bumps are not connected to the base.



11.5 Replacing VR1 Knob as a Three-position Switch

1

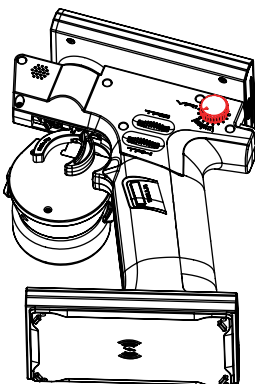

► Make sure that the knob needs to be replaced with a three-position switch.

2

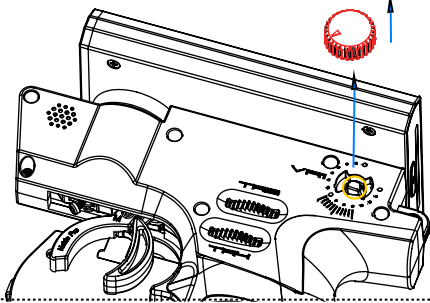

► Turn the knob clockwise until the knob is loose. Pinch the knob with the thumb and index finger and then lift it upward to remove the knob.

3

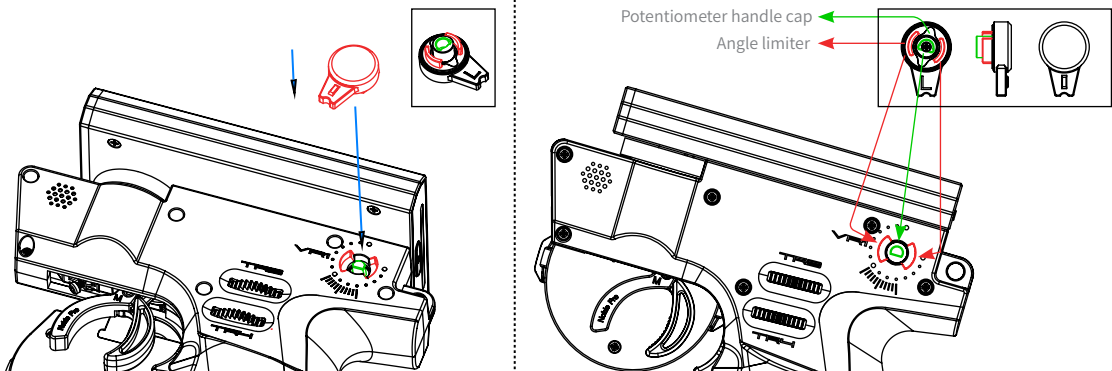

► Prepare a three-position switch to be replaced by first aligning the angle limit flap of the three-position switch with the angle limit slot on the transmitter, then align the potentiometer handle cap of the switch with the potentiometer handle of the transmitter. When the angle limit flap and the potentiometer handle cap are aligned at the same time, press the switch firmly by hand.

4

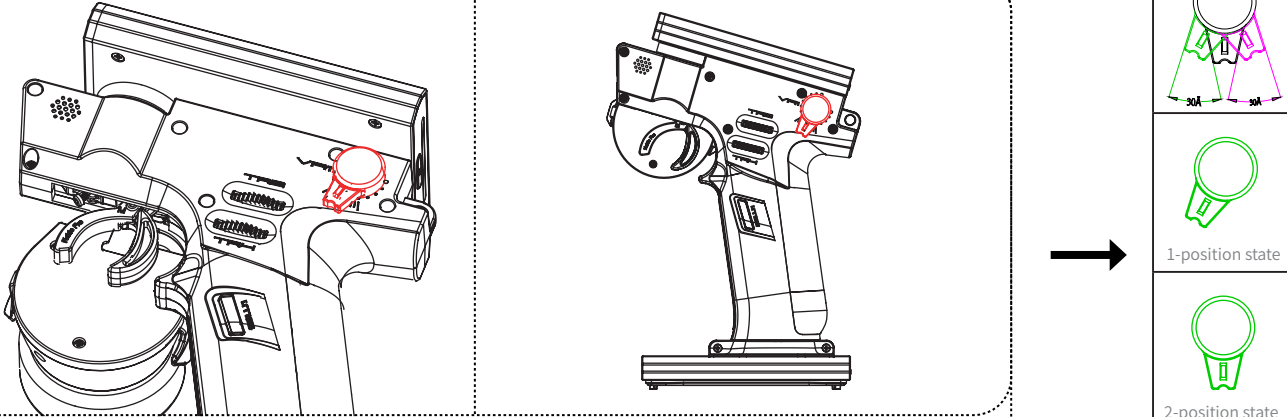

► After installation, turn the knob left and right to test if it is installed correctly.

! Pay attention to your strength in the process of replacing the three-position switch to avoid damaging accessories.
Please refer to the above steps for installation. Make sure the product can work properly after installation.



微信公众号



Bilibili



Website



Facebook

11.6 Replacing the 3-position Switch as VR1 Knob

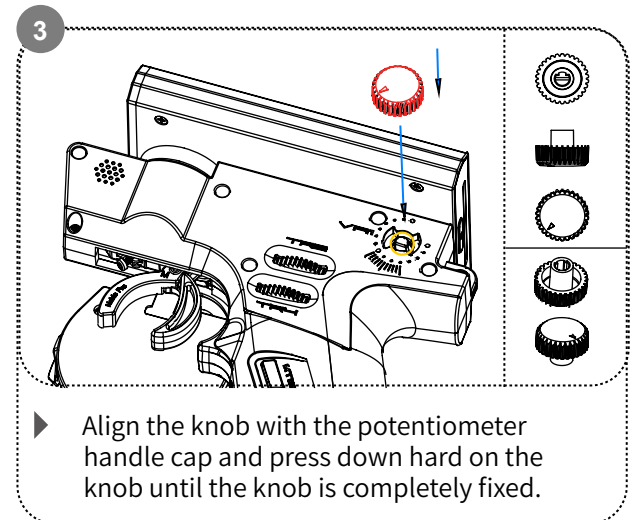
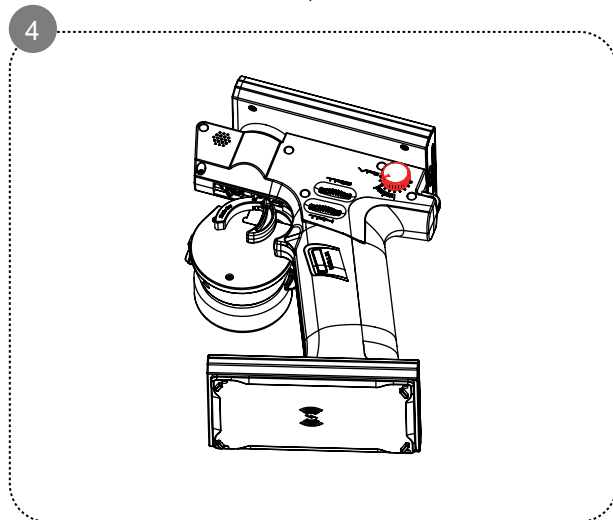
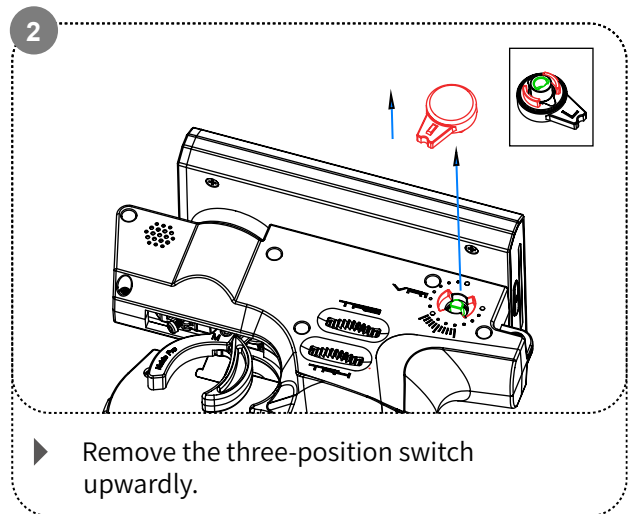
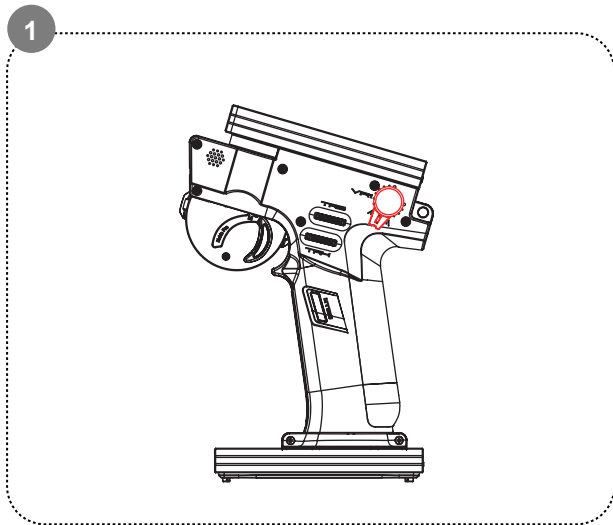

12. Certification

12.1 DoC Declaration

Hereby, [Flysky Technology Co., Ltd.] declares that the Radio Equipment [Noble pro(Noble Pro)] is in compliance with RED 2014/53/EU.

The full text of the EU DoC is available at the following internet address: www.flyskytech.com/info_detail/10.html

12.2 CE Warning

The antenna(s) used for this transmitter must be installed to provide a separation distance of at least 20 cm from all persons and must not be co-located or operating in conjunction with any other transmitter. End-users and installers must be provided with antenna installation instructions and transmitter operating conditions for satisfying RF exposure compliance

12.3 Environmentally friendly disposal

Old electrical appliances must not be disposed of together with the residual waste, but have to be disposed of separately. The disposal at the communal collecting point via private persons is for free. The owner of old appliances is responsible to bring the appliances to these collecting points or to similar collection points. With this little personal effort, you contribute to recycle valuable raw materials and the treatment of toxic substances.

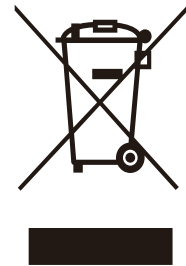

CAUTION

RISK OF EXPLOSION IF BATTERY IS REPLACED BY AN INCORRECT TYPE.
DISPOSE OF USED BATTERIES ACCORDING TO THE INSTRUCTIONS



微信公众号



Bilibili



Website



Facebook

12.4 FCC Statement

This equipment has been tested and found to comply with the limits for a Class B digital device pursuant to part 15 of the FCC rules. These limits are designed to provide reasonable protection against harmful interference in a residential installation. This equipment generates, uses and can radiate radio frequency energy and, if not installed and used in accordance with the instructions, may cause harmful interference to radio communications. However, there is no guarantee that interference will not occur in a particular installation. If this equipment does cause harmful interference to radio or television reception, which can be determined by turning the equipment off and on, the user is encouraged to try to correct the interference by one or more of the following measures:

- Reorient or relocate the receiving antenna.
- Increase the separation between the equipment and receiver.
- Connect the equipment into an outlet on a circuit different from that to which the receiver is connected.
- Consult the dealer or an experienced radio/TV technician for help.

To assure continued compliance, any changes or modifications not expressly approved by the party responsible for compliance could void the user's authority to operate this equipment.

This equipment complies with Part 15 of the FCC Rules. Operation is subject to the following two conditions:

- (1) This device may not cause harmful interference, and
- (2) This device must accept any interference received, including interference that may cause undesired operation.

Caution!

The manufacturer is not responsible for any radio or TV interference caused by unauthorized modifications to this equipment. Such modifications could void the user authority to operate the equipment.

1. Move all your channels to the desired position.
2. Select [All channels] and then [Yes] in the confirmation box.





www.flysky-cn.com

Copyright ©2023 Flysky Technology Co., Ltd.

Release date: 2023-04-03



微信公众号



Bilibili



Website



Facebook



FCC ID: N4ZFG400

Manufacturer: ShenZhen FLYSKY Technology Co., Ltd.
Address: 16F, Huafeng Building, No. 6006 Shennan Road, Futian District, Shenzhen, Guangdong, China