

INSTRUCTION MANUAL

PROGBOX SK-300046



INTRODUCTION

Thank you for purchasing SkyRC Program Box (SK-300046). Please read this entire operating manual completely and attentively as it contains important information. SkyRC Program Box is a very sophisticated electronic device that controlled by high performance microprocessor.

With compact size and easy operation, SkyRC Program Box offers six-in-one functions:

1. ESC Setting
2. LiPo Battery Monitor
3. Input PPM Signal Monitor
4. Servo Tester
5. Motor KV/RPM Tester
6. PC Interface - Link ESC to PC



FUNCTION

1. ESC Setting: It can work as a Program Box, an individual device which can be used to programming the ESC, and the option of each parameter is displayed on the LCD screen;
2. LiPo Battery Monitor: It can check the total cell number, total voltage, each cell voltage, highest voltage and lowest voltage and the voltage difference between the highest voltage and lowest voltage.
3. Input PPM Signal Monitor: It can check the output voltage from the receiver and the receiver's PPM signal width and frequency.
4. Servo Tester: It can check the input voltage, servo travel position and peak current.
5. Motor KV/RPM Tester: It can check the motor KV, RPM and input voltage.
6. It can also work as SkyLINK, an USB adaptor which can be used to link the ESC with a PC, and the user can update the firmware of the ESC or programming the ESC by SkyLINK software on PC.

SPECIFICATIONS

- Input Voltage (ESC Setting): 6-10VDC
- Input Current (ESC Setting): 500mA
- Idle Current (ESC Setting): <20mA
- Operating Temperature: 0-40°C
- Storage Temperature: -10 — 60 °C
- Operating Humidity: 10 - 90%RH
- Storage Humidity: 20 - 75%RH
- Protection Class: IP20
- Dimension: 85x48.5x11.8mm
- Weight: 40g

APPLIATION

There are four keys on the front panel,

ENTER : You could press this key to enter into the referred menu or confirm your selection.

▲ And **▼** : You could press these two keys to go to previous page and to go to next page or change the value of referred item.

ESC : You could press this key to go back to previous menu.

1. ESC Setting

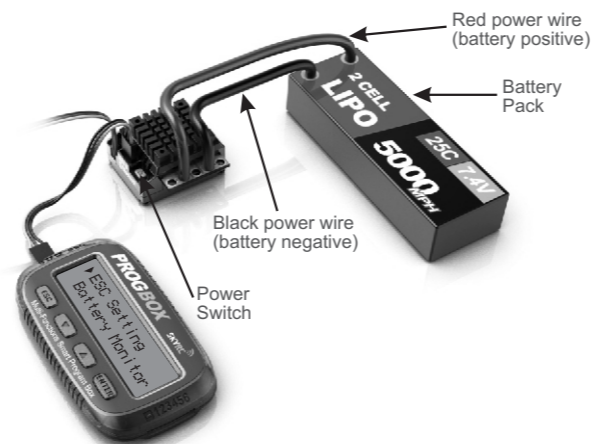

Connect the Program Box as the diagram above, turn on the ESC and do as follows, Press **ENTER** key to enter different programmable items, press **▲** and **▼** key to browse all the options and press **ENTER** key to confirm your selection and then the screen will go back to main programmable menu.

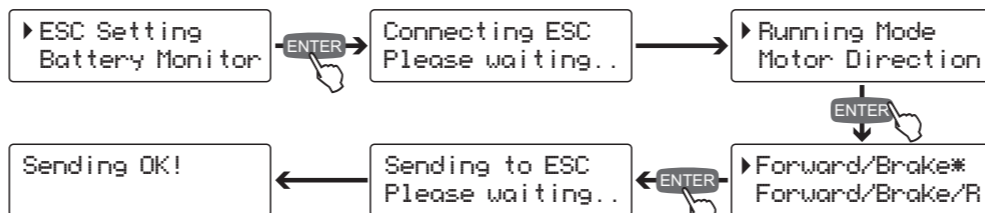

When the screen displays the programed item, you could press "ESC" key to main programmable menu and start to program next item.

Note: The programmable items differs depends on 1/10th, 1/8th and 1/5th ESC. Concerning to screen above, we take SkyRC Toro 1/10th 120A ESC(SK-300044) as example.

2. Battery Monitor

It could check the total cell number, total voltage, each cell voltage, highest voltage and lowest voltage and the voltage difference between the highest voltage and lowest voltage.



LiPo Battery Connection Diagram

Connect the Program Box and the battery as the diagram above, monitor battery voltage as follows,

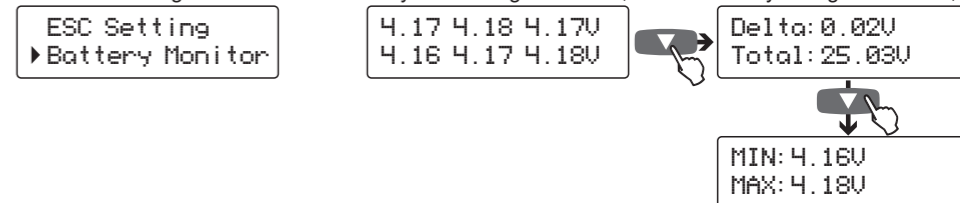

3. PPM Monitor

It can check the output voltage from the receiver and the receiver's PPM signal width and frequency. Connection



Connect the Program Box with the ESC, receiver as the diagram above, and turn on the ESC and the transmitter.

Please note that the Program Box must be inserted in to the Throttle Channel and the ESC can be inserted to any channel of the receiver as it is used to supply power to the receiver.

When it connects the battery, ESC, receiver, it could check the output voltage from the receiver and the receiver's frequency and the neutral pulse position.

At this time, hold full throttle and hold full brake to check the receiver's PPM signal width.

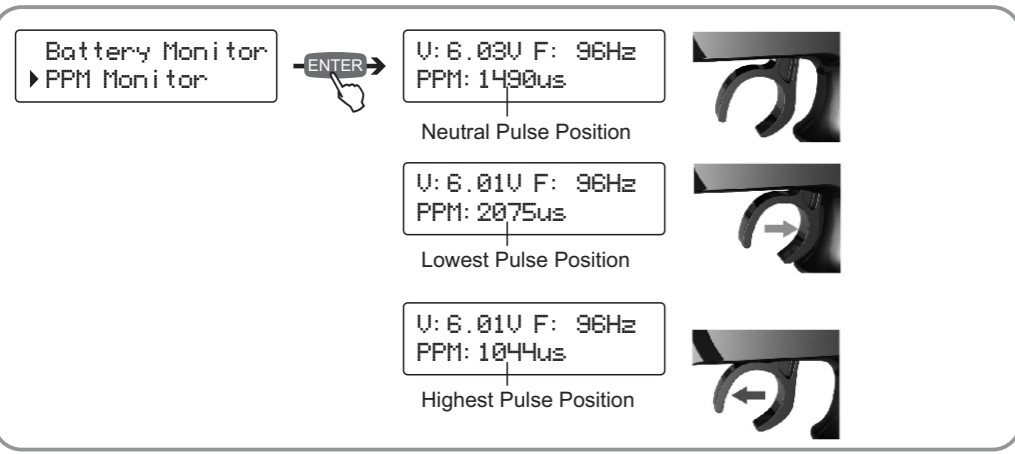

4. Servo Tester
It can check the input voltage, servo travel position and peak current. The default servo neutral position is 1520us/100Hz and 760us/100Hz. If the testing servo is not 1520us/100Hz and 760us/100Hz, please enter CUSTOM and set the servo neutral position (range: 200-2000us) and frequency (range: 50-200Hz) by yourself. There are two kinds of mode (Swing Mode and Manual Mode) to make the servo swing and check the servo travel position. Swing Mode: it will send out a signal to make the servo swing automatically. Manual Mode: it allows you to change the PPM signal and check the servo's response to the signal.

Connection

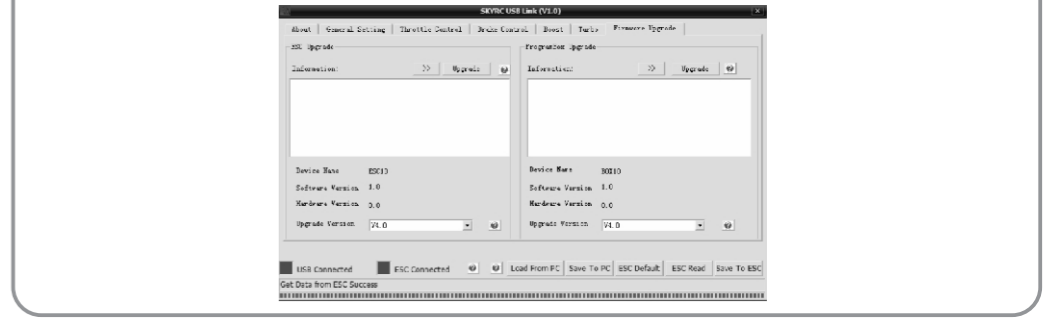
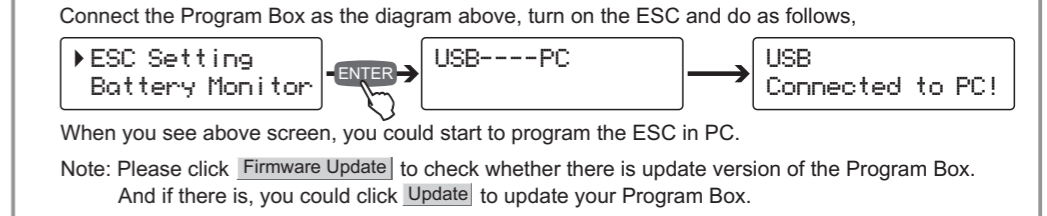
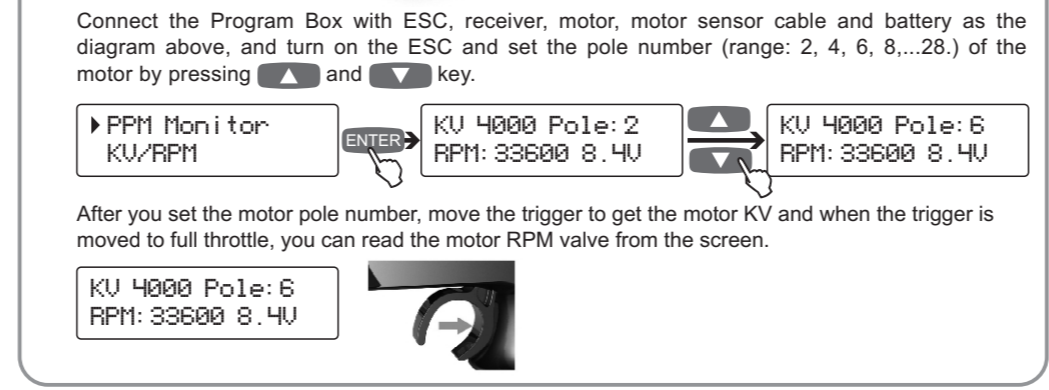
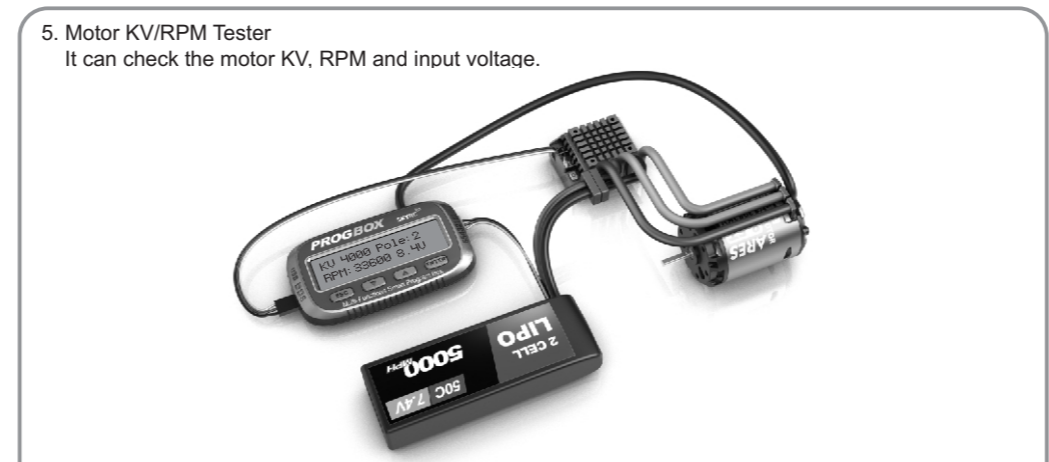
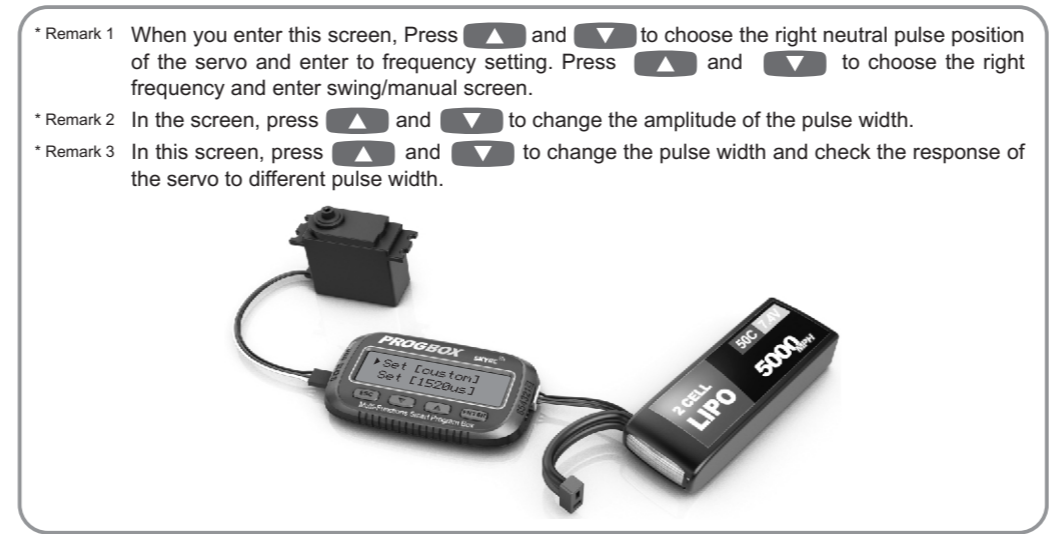
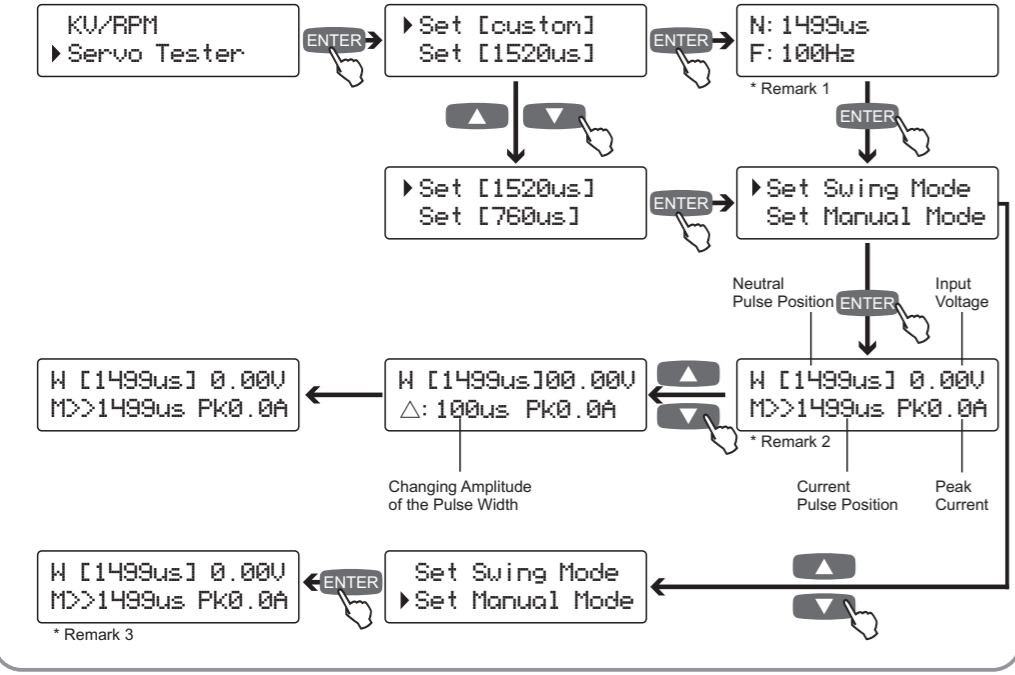

WARRANTY AND SERVICE

We guarantee this product to be free of manufacturing and assembly defects for a period of one year from the time of purchase. The warranty only applies to material or operational defects, which are present at the time of purchase. During that period, we will repair or replace free of service charge for products deemed defective due to those causes. You will be required to produce proof of purchase (invoice or receipt). This warranty is not valid for any damage or subsequent damage arising as a result of misuse, modification or as a result of failure to observe the procedures outlined in this manual.

CE RoHS

Manufactured by
SKYRC TECHNOLOGY CO., LTD.
www.skyrc.com