

C6D PRO

INTELLIGENT BALANCE CHARGER/DISCHARGER



DC 300W/AC 100W



Newly added FB-DCHG mode



Count battery using times



With built-in tire warmer mechanism/servo test/Motor-run function



Support AGM/PB battery



Battery repairing function



Battery warmer function

Thank you for purchasing the balance charger. This is a rapid charger/discharger with built-in balancer, computerised with microprocessor and can support scan QR code charging and phone APP control. Please read the entire operating manual completely and attentively before using.



G.T.POWER®

Contents

1. Specifications	02
2. Features.....	03
3. The exterior appearance of the unit	05
4. Warnings and safety notes.....	06
5. Program flow chart	08
6. Charging current setting.....	09
7. Lithium battery (Lilon/LiPo/LiFe/LiHv) program.....	09
8. NiMH/NiCd battery program	13
9. PB battery program	15
10. DJI Phantom series battery charge program.....	17
11. Cell Meter test program	17
12. IR Test	18
13. Special function introduction	19
14. Memory Mode	21
15. Load Mode.....	21
16. User settings.....	22
17. APP instruction	24
18. Warning and error messages.....	25
19. Warranty and service.....	26

1. Specifications

Input voltage	AC.100-240V, DC.11-26V
Charge current	0.1-12A
Discharge Current	0.1-3A, 12A in FB-DIS mode
Charge Power	AC.Max.100W, DC Max 300W
Discharge Power	max.5W, 300W in FB-DIS mode
Balance Current	max.1A
Balance Tolerance	$\pm 0.01V$
Charging Capability	LiXX:1-6cells NiXX:1-15cells
Pb Battery Voltage	Pb:2-20V
Weight	424g
Dimensions	119*122*53.5mm

2.Features

【Optimized operating software】

This unit can automatically adjust current according to the change of the charging time and battery voltage when charging or discharging. It can avoid battery explosion due to user's inappropriate operation especially when charging LiXX batteries. This charger provides a balance port for lithium batteries suitable for 2-6 cells.

【High Power and High Performance Circuits】

This charger's maximum output power is 300W, maximum charging current is 12A, maximum discharging current is 3A. Its high efficiency cooling system can guarantee the normal operation of the processor under such a big power.

【Individual voltage balancing for lithium battery packs】

The charger has a unique balancing function for lithium batteries inside, so no need extra balancer to balance the voltage when charging for Lilo/LiPo/LiFe/LiHv batteries.

【Monitor and balancing individual cell voltage】

It can monitor and balance individual cell voltage when discharging. It will stop discharge when the battery voltage is abnormal.

【Suit for variety of lithium batteries】

It can be compatible with Lilo, LiPo, LiFe, LiHV, NiCd, NiMH, Pb, AGM and Phantom2, phantom3 batteries. You can set parameters according to battery types and specifications.

【Lithium battery Fast charge and Storage mode.】

Fast charge reducing the charging time and storage mode can keep the rated voltage of lithium batteries stored for a long time

【Maximum safety】

Delta-peak sensitivity: It is an automatic charge current termination program. Its working principle is to turn off the charging current to complete charging when the battery voltage rises to the highest point and starts to fall down. (NiCd/NiMH)

Charging capacity limit: Charging capacity is calculated through charging current multiplied by charging time. When set the maximum charging capacity, the charging program will be forced to end when charging capacity exceeds the setting value.

Temperature limit: The inner temperature will rise when charging. When set a maximum temperature, the charging program will be forced to end when charging temperature exceed the setting value. This function need to connect exterior temperature sensor.

Charge time limit: You can through restrain the charge time to prevent any possible over charge/discharge.

Input voltage checking: To protect battery, program will automatically shut down the charging current when the voltage decreased to the lowest.

Automatic cooling fan: The cooling system will run automatically when the internal temperature raised and intelligently adjust speed according to temperature.

【Cyclic charging/discharging】

Perform 1-5 times charging/discharging cycles continually to refresh and activate long-term unused NiCd/NiMH battery.

3. The exterior appearance of the unit

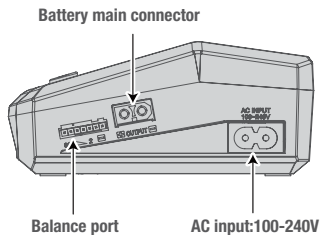
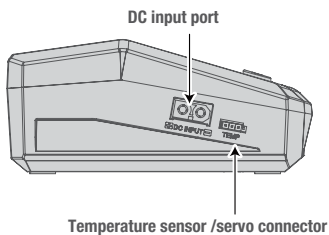
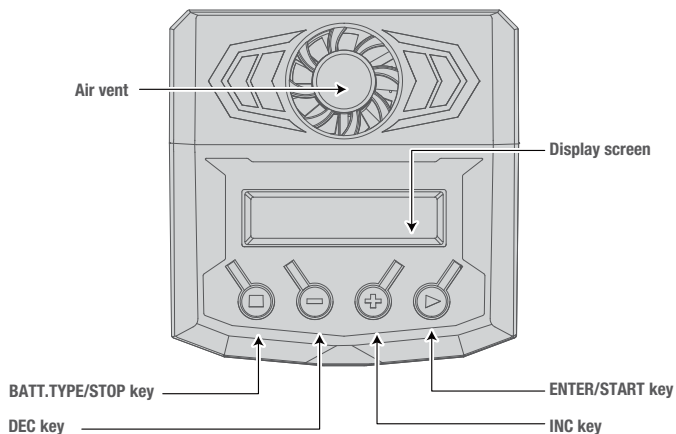

4. Warnings and Safety notes

- Never leave the charger unsupervised when it is connected to power. If any malfunction happens, terminate the program immediately and refer to the operation manual for the right operation.
- Keep the unit away from dust, damp, rain, heat, direct sunshine and vibration. Do not drop it.
- The unit circuit is designed by 11-26V for DC input and 100-240V for AC input only.
- The charger and the battery to be charged should be set up on a heat-resistant, non-flammable and non-conductive surface. Please ensure that the fan and vents of the charger are not blocked by the surface that it is placed on.
- Never block or cover the cooling-vent of unit to keep well-ventilated. Please set up parameter of battery correctly. Otherwise, the battery may be damaged. Especially for Lithium battery, it may cause a fire or an explosion by over-charging.
- To avoid short circuit between the charge leads, always ensure the leads are connected to the charger first and only then plugged into the battery. Always make sure that no batteries are connected to leads before disconnecting them from the charger.
- You have to pay attention to verify the capacity and the voltage of the Lithium battery pack. It may be composed of parallel and series connection mixed. In parallel link the capacity of the battery pack is multiplied by the number of cells but the voltage remains the same. That kind of voltage imbalance may cause a fire or explosion during charge process. We recommend you compose the Lithium battery pack in series only.

Discharge

- The typical purpose of discharge is to determine the residual capacity of the battery, or to lower the voltage of battery to a defined level. When you discharge the battery you also have to pay attention on the process same as charging. To avoid the battery becoming deep-discharged, set the final discharge voltage correctly. Lithium batteries should not be deep-discharged to lower than the minimum voltage, as this will lead to a rapid loss of capacity or a total failure. Generally, you do not need to discharge Lithium battery voluntarily.
- Some rechargeable batteries are said to have a memory effect. If they are partly used and recharged before the whole charge is drawn out, they 'remember' this and next time will only use that part of capacity. This is a 'memory effect'. NiCd and NiMH batteries are both have this 'memory effect'. They prefer complete cycles, fully charge then use until capacity empty. NiMH batteries have less memory effect than NiCd.

- The Lithium battery prefers a partial rather than a full discharge. Frequent full discharges should be avoided if possible. Instead, charge the battery more often or retain normal voltage.
- The brand-new NiCd battery pack is partially useful with its capacity until it has been subjected to 10 or more charge cycles in any case. The cyclic process of charge and discharge will lead to optimise the capacity of battery pack.

Those warnings and safety notes are particularly important. Please follow the instructions for a maximum safety; otherwise the charger and the battery can be damaged violently. And also it can cause a fire to injure a human body or to lose the property.

NiCd/ NiMH	voltage level: allowable fast charge current: discharge voltage cut off level:	1.2V/cell 1C~2C depends on the performance of cell 0.85V/cell(NiCd), 1.0V/cell(NiMH)
Lilon	voltage level: max.charge voltage: allowable fast charge current: min.discharge voltage cut off level:	3.6V/cell 4.1V/cell 1C or less 2.5V/cell or higher
LiPo	voltage level: max.charge voltage: allowable fast charge current: discharge voltage cut off level:	3.7V/cell 4.2V/cell 1C or less 3.0V/cell or higher
LiFe	voltage level: max.charge voltage: allowable fast charge current: discharge voltage cut off level:	3.3V/cell 3.6V/cell 4C or less(e.g. A123M1) 2.0V/cell or higher
LiHV	voltage level: max.charge voltage: allowable fast charge current: min.discharge voltage cut off level:	3.8V/cell 4.35V/cell 1C or less 3.0V/cell or higher
Pb (Lead- acid)	voltage level: max.charge voltage: allowable fast charge current: discharge voltage cut off level:	2.0V/cell(Lead-acid) 2.46V/cell 0.4C or less 1.50V/cell or higher

5. Program flow chart

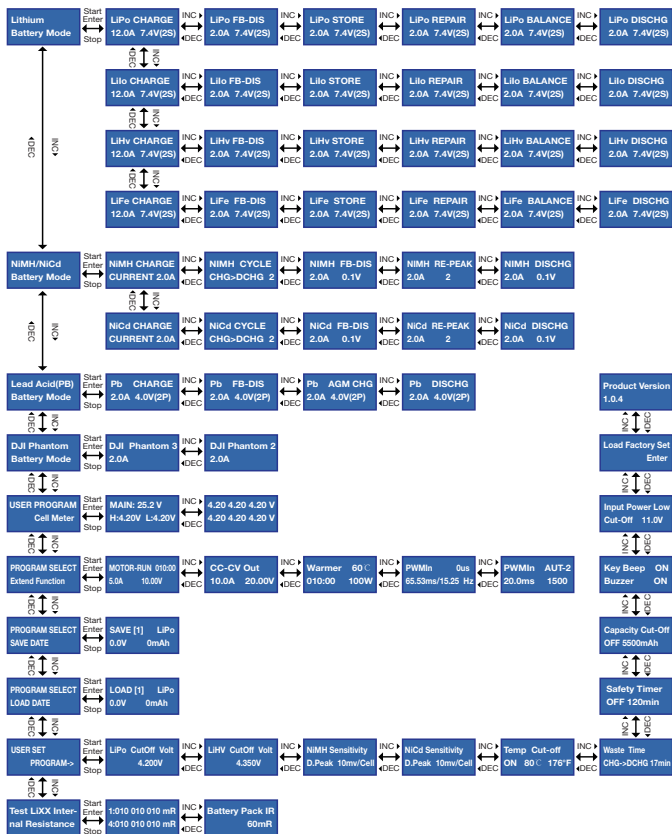

6. Charging current setting

You have to know the battery allowable maximum charging current before charging. Charging current exceeds the allowable maximum charging current may cause damage to battery and it is possible to lead a fire and explosion of battery when charging.

We usually use C value to mark battery charging/discharging capability. The battery allowable maximum charging current is calculated by multiply C value by battery capacity. For example, if battery is 1000mAh, 5C, then the allowable maximum charging current is $1000 * 5 = 5000\text{mA}$, that is the battery maximum allowable charging current is 5A.

To Lithium batteries, if you can't confirm battery's C value, for your safety, please set charging current no more than 1C.

The relationship between C value and charging time is, charging time $\geq 60\text{minutes}/\text{C value}$, for example, charging with 1C, charging finish time need 60-70 minutes. This time may be extended due to different battery performance.

7. Lithium battery(LiIon/LiPo/LiFe/LiHv)program

These program suit for Lilo/LiPo/LiFe/LiHv battery pack charge/discharge. You have to choose the right program according to different lithium battery performance.

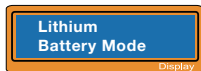

Select lithium battery charge mode, short press enter key to the program.

Short press 'Start/Enter' key to select battery types (LiPo, LiFe, Lilo, LiHv) and program modes, such as balance charge, discharge, FB-DIS, storage, repair, normal charge, then, you can through press INC and DEC key to change the current value (0.1-12A), discharge current value (0.1-3A), FB-DIS discharge current value (0.1-12A). The same operation method to set battery voltage and cells (1-6S).

For your attention, you need to connect the battery to the charger's output plug as well as the balance port correctly when charging.

7.1 Lithium battery balance charge mode

This is for balancing the voltages of Lithium batteries of the battery pack to be fully charged. Inner system will monitor each cell's voltage and restraint each cell's current to fulfill balance charging. You need to connect the battery to the charger's output plug as well as the balance port when charging.

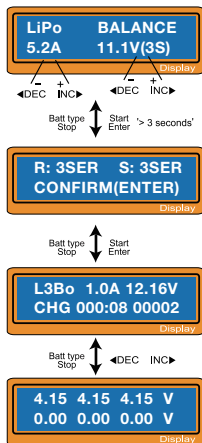

The second line left side to set charge current value, right side to set the battery pack voltage value. After done, press and hold Start/Enter for 3 seconds to start the program. (charge current: 0.1~12.0A, cell voltage: 1~6cells)

This shows the number of cells you set and the processor detected. 'R' shows the number of cells found by the charger and 'S' shows the number of cells you selected at previous menu. If both numbers are the same, you can start charging by press Start/Enter button. If not, press Batt type/Stop key go back to the last menu to double check battery pack cell number and charge again.

It shows the current charging status, press Batt type/Stop key to stop charging.

It shows the individual cell voltage of each battery pack.

7.2 Discharging Lithium battery

The aim of discharging is to check the battery remaining capacity or to check the health status of battery. To avoid deep discharging, you need to set a right rated discharging voltage when discharging. Lithium battery voltage should not lower than its rated voltage in case causing any fast loss of battery capacity. In normal case no need to discharging Lithium battery. For your safety, charger's discharging current should not exceed the maximum discharging current specified by the battery manufacturer, rated voltage should not lower than the lowest discharging voltage specified by the battery manufacturer to avoid deep discharging.

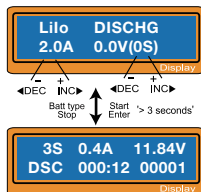

The second line left side to set discharge current value, right side to set the battery pack voltage value. After done, press and hold Start/Enter for 3 seconds to start the program.
(discharge current: 0.1~3.0A, cell voltage: 1~6cells)

It shows the current discharging status. Press Batt type/Stop to stop discharge.

7.3 Storage mode for Lithium battery

Lithium battery storage mode is to adjust each kind of battery voltage to a certain level (LiPo:3.85V, Lilo:3.75V, LiFe:3.3V, LiHV: 3.85V, this will make lithium batteries suitable for long-term storage. If the voltage of the battery at its initial stage is higher than the rated voltage, the program will start to discharge. If lower than the rated voltage, will start to charging.

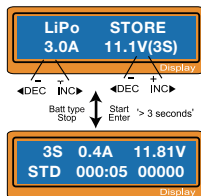

The second line left side to set storage current value, right side to set the battery pack voltage value. After done, press and hold Start/Enter for 3 seconds to start the program.
(storage current: 0.1~3.0A, cell voltage: 1~6cells)

It shows the current storage status. Press Batt type/Stop to stop storage.

7.4 Lipo battery repair

This program can be used to repair the voltage gap between battery packs through a unique program to charge the low voltage cell with a small current to increase the battery activity, so that the voltage of each cell in the whole battery pack is consistent.

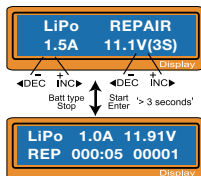

The second line left side to set charge current value, right side to set the battery pack voltage value. After done, press and hold Start/Enter for 3 seconds to start the program.
(charge current: 0.1~1.5A, cell voltage: 1~6cells)

It shows the current status, press Batt type/Stop to stop the repair program.

7.5 LiPo FB-DIS mode

You have to use this mode under DC working status and input port connected to battery, otherwise will report an error. FB-DIS working principle is transmit the standby discharging battery capacity to input battery through the charger and achieved the discharge effect. For your safety, the screen shows discharge current should not exceed the battery manufacturer allowed maximum discharge current value, rated voltage should not exceed the battery manufacturer allowed lowest voltage value, in case deep discharge.

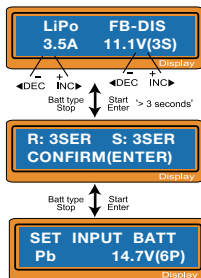

The second line left side to set charge current value, right side to set the battery pack voltage value. After done, press and hold Start/Enter for 3 seconds to start the program. (charge current: 0.1~12.0A, cell voltage: 1~6cells)

Press ENTER to start program.

Set battery type and voltage value, then press and hold Start/Enter for 3 seconds to start the program.

7.6 Charging Lithium battery in balance mode

It should connect the battery to the input connector and also connect the balance connector when charge.

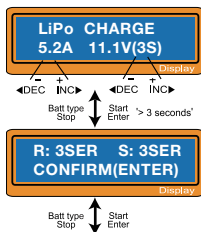

The second line left side to set charge current value, right side to set the battery pack voltage value. After done, press and hold Start/Enter for 3 seconds to start the program. (charge current: 0.1~12.0A, cell voltage: 1~6cells)

It shows your set cell counts and charger detected cell counts. R: shows the charger detected cell counts, S: shows cell counts you selected in you last menu, if the value is the same, press Start/Enter to start charge. If S and R value not the same, press Batt type/Stop back to last menu and check clear cell counts before charging.



Batt type / Stop
 ↓ ↑
 ← DEC INC →

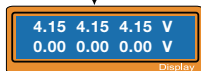

It shows the current charging status, press Batt type/Stop to stop charge.

It shows each battery pack single cell voltage.

8. NiMH/NiCd battery program

It is designed for charging and discharging NiMH or NiCd battery that commonly used for R/C model .



Batt type / Stop
 ↓ ↑
 Start / Enter > 3 seconds'

The screen turns bright when press Start/Enter, then you can press DEC/INC to change the parameter value, press Start/Enter to store

8.1 Charge NiCd/NiMH battery

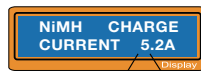

Batt type / Stop
 ↓ ↑
 ← DEC INC →
 Start / Enter > 3 seconds'

The second line left side to set charge current value, right side to set the battery pack voltage value. After done, press and hold Start/Enter for 3 seconds to start the program. (charge current: 0.1~12.0A)



Press Start/Enter for 3 seconds to start the program.

8.2 Discharging NiCd/NiMH battery

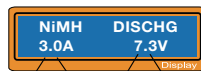

← DEC INC →
 ↓ ↑
 Batt type / Stop
 Start / Enter > 3 seconds'

The second line left side to set charge current value, right side to set the battery pack voltage value. After done, press and hold Start/Enter for 3 seconds to start the program. (discharge current: 0.1~3.0A, battery voltage: 0.8-25V)

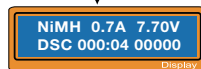

The screen shows the current discharging status, press Batt type/Stop to stop discharge.

8.3 NiMH /NiCd battery charge and discharge cycling mode

Set the sequence on the left and the number of cycle (1-5) on the right. You can use this function to balance and refresh or cut off battery. To avoid battery temperature rising, there will be a brief cooling process after each charge and discharge cycle. In this process, press "Batt type /stop" to stop the program.

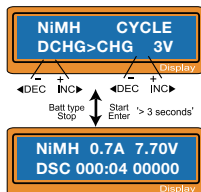

DCHG: discharge, CHG: charge

Press Start/Enter for 3 seconds to start the program.

8.4 NiMH/NiCd Battery second charge

The charger has the new program which can charge the battery for second time. (The battery which do not use for a long time or the old battery or the battery which can not arrive the Max voltage after the first charge). In this way, this mode can make the battery's capacity to the standard value and can extend the battery's using time.

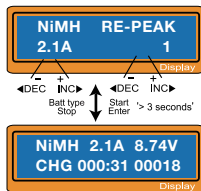

Set the charge current in the left, set the second charge times in the right. Press "Start/Enter" for 3seconds to start the program and the program will stop by press "Batt type/Stop". (Charge current 0.1-12.0A, 1-3 times)

Press Start/Enter for 3 seconds to start the program.

8.5 NiMH/NiCd Battery FB-DIS

FB-DIS can only be operated when the battery is connected to the input interface under DC mode, otherwise will report error. The FB-DIS mode is to transfer the capacity of the battery to be discharged to the input battery through the charger to achieve the purpose of

discharge. For your safety, the discharge current value displayed on the screen should not exceed the maximum discharge current specified by the battery manufacturer, and the rated voltage should not be lower than the voltage level recommended by the battery manufacturer to avoid deep discharge. Select discharge battery type and voltage correctly.

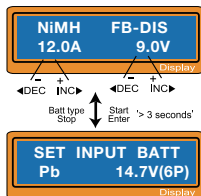

Set the charge current value on the second line left side, set the battery pack voltage on the right side. After set finished, press and hold Start/Enter for 3 seconds to start the program.(current:0.1~12.0A,battery voltage:0.8-25V)

Press ENTER to start program

Set input battery type and voltage, press and hold Start/Enter for 3 seconds to start the program.

9、Pb battery program

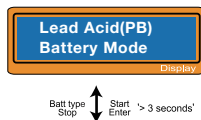

This program is used for charging/discharging Pb batteries, rated voltage from 2 to 20V.Pb batteries are different from NIMH/NiCd batteries,Pb battery has a lower battery capacity than NIMH/NiCd battery, they can only pass relatively lower current,as well as have some current restraints during charging process.Pb battery's current is 1/10 of its battery capacity, it can't fast charging, you have to refer to the specifications of the battery manufacturer when charging.

9.1 Charging Pb battery

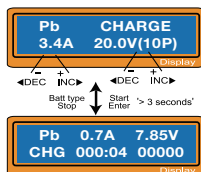

Set charge current on the left side and nominal voltage on the right. Press Start /Enter for 3 seconds to start the charging process. (current:0.1~12.0A, battery voltage:1-10P)

9.2 Discharging Pb battery

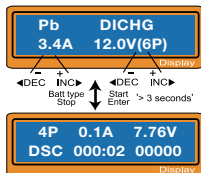

Set discharge current on the left side and nominal voltage on the right. Press Start /Enter for 3 seconds to start the discharging process. (current: 0.1~3.0A, battery voltage: 1-10P)

9.3 Pb battery FB-DIS

FB-DIS can only be operated when the battery is connected to the input interface under DC mode, otherwise will report error. The FB-DIS mode is to transfer the capacity of the battery to be discharged to the input battery through the charger to achieve the purpose of discharge. For your safety, the discharge current value displayed on the screen should not exceed the maximum discharge current specified by the battery manufacturer, and the rated voltage should not be lower than the voltage level recommended by the battery manufacturer to avoid deep discharge. Select discharge battery type and voltage correctly.

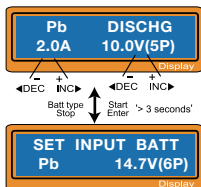

Set the discharge current value on the second line left side, set the battery pack voltage on the right side. After set finished, press and hold Start/Enter for 3 seconds to start the program. (current: 0.1~12.0A, battery voltage: 1-10P)

Press ENTER to start program

Set input battery type and voltage, press and hold Start/Enter for 3 seconds to start the program.

9.4 AGM battery charge program

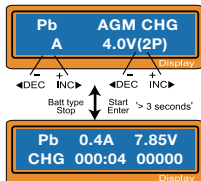

This charge program is specially designed for AGM battery.

The second line left side to set the charge current, the right side is to set the battery pack voltage. After finished set, press and hold Start/Enter for 3 seconds to start the program. (current: 0.1~12.0A, battery voltage: 1-10P)

10. DJI Phantom series battery charge program

**DJI Phantom
Battery Mode**

Display



C6DPRO Charger is the intelligent multi-functional charger. It can charge many different battery types and can also charge DJI batteries.

10.1 DJI Phantom 3 battery charge program

**DJI Phantom 3
2.1A**

Display

◀DEC + INC▶



The battery's capacity of Phantom 3 professional and Phantom 3 is 4480mAh and the standard voltage is 15.2V.

It is easy to operate the charger to charge the DJI batteries. Connect the battery and press Start/Enter over 3 seconds to start the program and press Batt type/Stop to stop the charge.

10.2 DJI Phantom 2 battery charge program

**DJI Phantom 2
2.1A**

Display

◀DEC + INC▶



The battery's capacity of Phantom 2 and Phantom 2 vision and Phantom 2 Vision+ is 5200mAh and the standard voltage is 11.1V.

Connect the battery and choose the charge program of Phantom 2, then press Start/Enter over 3 seconds to start the program and press Batt type/Stop to stop the charge.

**Dron 0.4A 7.82V
CHG 000:06 00000**

Display

11. Cell Meter test program

This charger with built-in high-bit micro-processor, can be used as a cell meter. It can show the voltage of each cells, the total battery pack voltage and the highest/ lowest voltage.

**USER PROGRAM
Cell Meter**

Display



Choose the cell meter program interface, press START to enter, will show 1-6 cells voltage.

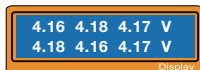

Batt type
Stop

↑ Start
↓ Enter

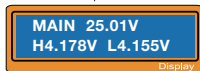

Press STATUS key to show the highest/lowest voltage of the single cell and the total voltage of the battery pack.

12、IR Test

Lithium battery internal resistance is one of the important index of battery discharge capability and efficiency. We can know battery performance and the matching of each battery by getting the battery IR value. The value more smaller the higher matching degree between the batteries. The charger detected battery IR value is its relative value not absolute value. It is the relative value under current testing voltage. But it can also know the battery performance and matching rate through this relative value. If you want more battery performance comparison, you had better put them under the same voltage to detect. For example, to compare two 3-cells batteries, you should ensure that the total voltage is consistent. Testing in the single voltage of 4.20V.



Batt type
Stop

↑ Start
↓ Enter > 3 seconds'

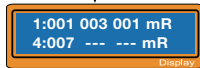

Batt type
Stop

↑ Start
↓ Enter



Choose IR test program, press START enter into the interface to show 1-6S IR value.

Press DEC/INC key to check the total IR value of battery pack

13. Special function introduction

We've added some extra functions for C6dpro, such as motor-run, digital power, tire warmer, PWM test etc.

13.1 Motor-run introduction

This program aims to test the quality of DC two-phase motor and check the quality of motor. Set the motor's input power, check its output current and power, assisted with certain test equipment to judge the motor using status and quality.

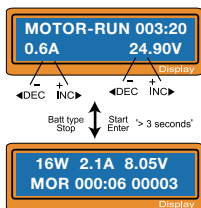

According to the program flow chart, select Motor run function, connect the positive and negative power supply lines of the DC motor to the positive and negative output terminals of the charger, adjust the current and voltage through press DEC/INC. After set finished, short press ENTER to finish voltage set.(current 0.1-12A, voltage: 0.2-25V)

After finished, long press ENTER enter into test interface. If need re-set, short press STOP back to set interface.

13.2 Digital power

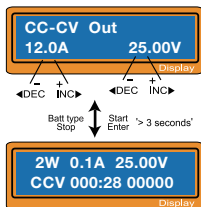

Under this program, this charger can be used as a digital power to power on other instrument, but can not be used as a charger to charge/discharge. Voltage range is 0.2 -15V, current 0.2-12A, max. Power 300W.

Select digital power program, Press and hold START for 2 seconds to start the program, interface will show the output voltage, current and power.

Press STOP to end the program, back to set interface.

13.3 Tire warmer function introduction

The tire warmer function is used for the hot-melt rc car tire. It can heat the hot-melt tire quickly and increase the grip force to the ground. To use this function, you need to equip with the heating cup.

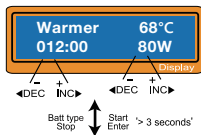

Short press Start/Enter to start the program, through press INC/DEC to set heating temperature, heating time, heating power.

Heating temperature 30°-100°, heating time 1-120 minutes, heating power 10-100W.

After finished, long press ENTER to test interface. If need re-set parameters, short press STOP back to set interface.

13.4 PWM IN introduction

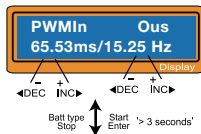

This program can be used to test the pulse width value of other equipment. Connect the servo tester to the 3pin temperature sensor port can measure the pulse width and frequency of PWM directly.

13.5 PWM OUT introduction

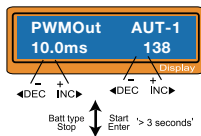

Connect the servo with 3pin temperature sensor port can test the servo parameters.

AUT-1, AUT-2, AUT-3 indicate three different speed automatic mode, MAN is manual mode, THR is three position mode(including the maximum position, the middle position, the minimum position). Then set PWM periodic value, normally the value is 50HZ(20MS), PWM value (Only need to set the min. Value and the max. Value under auto mode.)

14. Memory Mode

This charger can save setting data of each program, it can save 5 groups data for each kind of battery, including the cells of the battery, setting charge current and so on. Users do not need to set the data again when they use the batteries which have been memory. It is easier and more convenient to use.



Select memory mode, press Start to start set.

Batt type Stop
↑ Start
↓ Enter > 3 seconds'



Press STATUS to choose the number.

Batt type Stop
↑ Start
↓ Enter

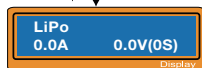

Press START to choose battery type. Short press START till the content flickering, through press DEC/INC to choose battery type, short press STATUS to set cell counts, charge current, discharge current.

After finished, long press START to save settings.

15. Load Mode



This program aims to retrieve the data stored in the "Save Data" program

Batt type Stop
↑ Start
↓ Enter > 3 seconds'

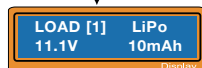

Press "Start /Enter" till contents flickering, then press INC/DEC to select number, press and hold "Start Enter" for 3 seconds to start program.

Batt type Stop
↑ Start
↓ Enter



Select the data you wanted to retrieve back and download.

Batt type Stop
↑ ↓ DEC INC



Long press ENTER to start program, press STOP to stop program.

16、User settings



◀DEC ↓

LiPo cut off voltage range is 4.15-4.25V, we'd suggest user set cut off voltage to 4.2V, to avoid exceed battery maximum charging voltage causing damage to battery and your property.

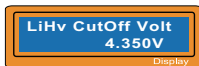

◀DEC ↓

LiHv cut off voltage range is 4.30-4.4V, we'd suggest user set cut off voltage to 4.35V, to avoid exceed battery maximum charging voltage causing damage to battery and your property.



◀DEC ↓

The automatic charge trigger voltage, the working principle is that after the battery voltage increased to the Maximum value and start to decreasing, then the charge current will turn off and finish the charge. If the trigger voltage set higher, there is a danger of over-charging. If it is too low, there is a possibility of stop charging prematurely. Please refer to the technical specification of the battery (NiCd default voltage: 12mv, NiMH default voltage: 7mv).



◀DEC ↓

There is a 3-pin socket on the left side of the charger, The middle row of pins is the temperature sensor interface. You can select this function on the screen, then insert the temperature sensor into the socket to monitor the temperature of the battery. When detect the battery temperature exceeds the set value, the charger will stop charging / discharging to prevent battery overheat to damage battery or causing more serious consequences.



◀DEC ↓

Battery cycling charging/discharging waste time setting. Battery temperature will rise when charging or discharging. You can through set Battery cycling charging/discharging waste time (can be 1-60 minutes) to let battery have enough time to cooling down between each cycling. You can set trickle charging mode to turn on/turn off. When turn on trickle charging mode, the charger will automatically provide a small charging current to achieve full

charging after the fast charging is over to avoid battery overheating.



◀DEC ↓

If you turn on safety timer when charging, safety timer will start timing too. If system fault or system can't identify battery capacity already full, this safety time set can stop battery being over charged. The safety time should not shorter than the battery fully charged time.



◀DEC ↓

Capacity cut-off program set the maximum charging capacity. If safety timer stopped work or system can't detect the peak voltage, this program will stop charging/discharging automatically if you've set the maximum charging capacity.



◀DEC ↓

Beep sound on/off; Buzzer sound on/off.



◀DEC ↓

The program set the lowest cut-off input voltage value is 10-20V. If the voltage lower than the set voltage level, procedure will be forced to end to protect input power.



◀DEC ↓

Resume to default setting



Product version inquiry

17、APP instruction

This unit with built-in high speed bluetooth module,you can connect app through bluetooth and set charge/discharge parameters on app, such as safety time, temperature protection, alarm sound on/off, capacity protection, low voltage protection and firm ware upgrade etc. It also support scan QR code to charge. You can download updated app through scan below QR code.



Scan the QR code to install the App of GT CHARGER

18. Warning and error messages

It combines a variety of protection functions and monitoring systems to identify its electronic functions and status. Screen will automatically display the error reason with a prompt tone if any error happens.

1.{" REVERSE POLARITY "}

Battery output Polarity connection wrong;

2.{" CONNECTION BREAK "}

Interruption of battery and output, or the charger wire is not connected well when operate the charge or discharge output.

3.{" OUTPUT SHORT CIRCUIT "}

Short-circuit of the output terminal. Please check the charger wire

4.{" INPUT VOLTAGE ERROR "}

The voltage of the input terminal is lower or higher than the setting limit

5.{" BATTERY LOW VOLTAGE "}

The voltage is lower than which is set. Please check the number of cells in the battery pack.

6.{" BATTERY HIGH VOLTAGE "}

The voltage is higher than which is set. Please check the number of cells in the battery pack.

7.{" CELL LOW VOLTAGE "}

Voltage of one cell in the battery pack is too low, please check the voltage of each cell.

8.{" CELL HIGH VOLTAGE "}

Voltage of one cell in the battery pack is too high; please check the voltage of each cell

9.{" CELL CONNECT ERROR "}

Wrong connection of the connector detected; please check the connector and cable.

10.{" CHARGER OVERHEATING "}

The internal temperature of the unit goes too high. Cool down the unit

19. Warranty and service

We warrant this product for a period of one year(12 months) from the date of purchase. The guarantee applies only to such material or operational defects, which are present at the time of purchasing the product. During that period, we will replace without service charge for any product deemed defective due to those causes. You will be required to present proof of purchase(invoice or receipt). This warranty does not cover the damage due to wear, overloading, incompetent handling or using of incorrect accessories.

CONFORMITY DECLARATION

G.T.POWER C6Dpro satisfies all relevant and mandatory CE directives and FCC Part 15 Subpart B. The product has been tested to meet the following technical standards:

	Test Standards	Title	Result
CE-LVD	EN60335-2-29	Household and similar electrical appliances –. Safety –. Part 2-29: Particular requirements for battery chargers.	Conform
	EN 60335-1	Household and similar electrical appliances - Safety - Part 1: General requirements	Conform
CE-EMC	EN55014-1	Electromagnetic compatibility – Requirements for household appliances, electric tools and similar apparatus – Part 1: Emission	Conform
	EN55014-2	Electromagnetic compatibility – Requirements for household appliances, electric tools and similar apparatus – Part 2: Immunity Product Family Standard	Conform
	EN61000-3-2	Electromagnetic compatibility (EMC) – Part 3-2: – Limits for harmonic current emissions (equipment input current up to and including 16 A per phase)	Conform
	EN61000-3-3	Electromagnetic compatibility (EMC) - Part 3-3: Limitation of voltage supply systems for equipment with rated current ≤ 16A.	Conform
FCC-VOC	FCC Part 15B	Title 47 Telecommunication PART 15 - RADIO FREQUENCY DEVICES Subpart B - Unintentional Radiators	Conform



WARNING!



FIRE HAZARD!

NEVER USE CHARGER UNSUPERVISED!

- Batteries pose a SEVERE risk of fire if not properly handled.
- Read Entire operation manual before using charger.
- This unit may emit heat during use.
- Only operate this device in a cool ventilated area away from flammable objects.
- Failure to observe safety procedures may cause damages to property or injury.

G.T.POWER[®]

