

Noble NB4

USER MANUAL

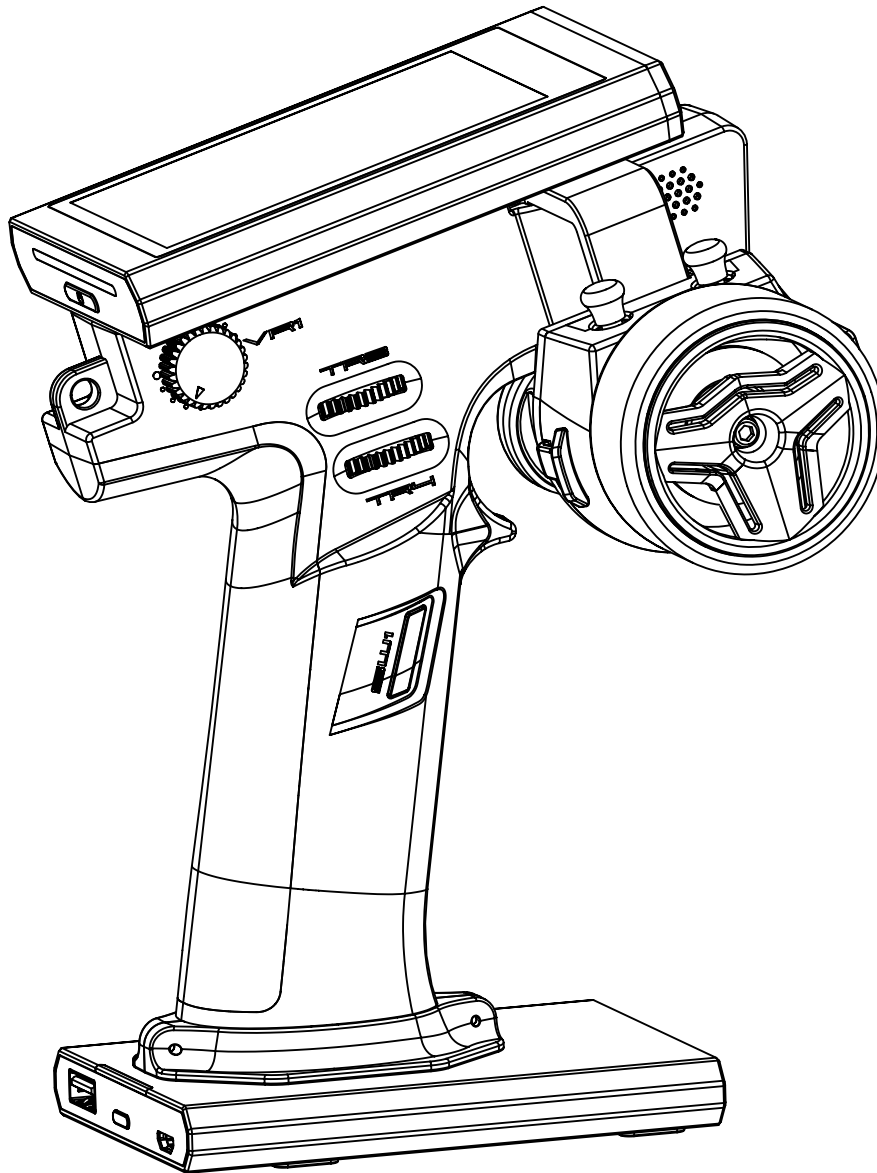

FLYSKY

Touching Infinity

Copyright ©2022 Flysky Technology co., ltd



WARNING:
This product is only for 15 years
old or above.

2.4GHz
AFHDS 3



Thank you for purchasing our product, an ideal radio system for beginners or experienced users.

In order to ensure your safety, and the safety of others, read this manual carefully before using this product. If you encounter any problem during use, refer to this manual first. If the problems persists, contact your local dealer or visit our service and support website:

www.flysky-cn.com

Contents



1. Safety	1
1.1 Safety Symbols	1
1.2 Safety Guide	1
2. Introduction	2
2.1 System Features	2
2.2 Transmitter Overview	3
2.3 Receiver Overview	6
2.3.1 Status Indicator	6
3. Getting Started	7
3.1 Transmitter Battery Installation	7
4. Operation Instructions	8
4.1 Power On	8
4.2 Binding	8
4.3 Transmitter LED Indicator	9
4.4 Power Off	9
5. System Interface	10
6. Function Settings	11
6.1 REV	11
6.2 EPA	11
6.3 SUB TR	12
6.4 ST DR/EXP	12
6.5 TH DR/EXP	12
6.6 ABS	13
6.7 Timer	15
6.8 ASSIGN	16
6.9 Model	18
6.10 Sensor	19
6.11 CH SPEED	22
6.12 MIXES	24
6.13 Throttle Middle	25
6.14 TH Neutral	26
6.15 TH Curve	26
6.16 Idle Up	26
6.17 ENG CUT	27
6.18 Boat	27
6.19 Display	27
6.20 Beginner	28
6.21 SVC	28
6.22 Help	29
7 RX SET	30
7.1 Bind With A Receiver	30
7.2 Steering Force	30

7.3 Gyro Gain.....	30
7.4 RX Interface Protocol	31
7.5 Failsafe.....	32
7.6 Servos Frequency	32
7.7 i-BUS Setup.....	33
7.8 Config PWM Converter	34
7.9 RSSI Output Setup	34
7.10 RX Battery Monitor.....	34
7.11 Range Test	35
7.12 BVD Voltage Calibration	35
7.13 Low Signal Alarm.....	35
7.14 Update Receiver.....	36
8. SYSTEM	37
8.1 Language.....	37
8.2 Units	37
8.3 Backlight adjustment.....	37
8.4 Sound.....	38
8.5 Vibration	38
8.6 LED.....	38
8.7 Home-Screen Quick Access	39
8.8 Mian Screen Lock Setup.....	39
8.9 Standby Timeout.....	39
8.10 Auto Power Off	39
8.11 Stick Calibration.....	40
8.12 Firmware Update.....	40
8.13 Factory Reset	40
8.14 About Noble	40
9. Transmitter Specification	41
9.1 Transmitter Specification (NB4).....	41
9.2 Receiver Specification (FGr4)	42
9.3 Receiver Specification (FGr4S)	42
10. Package Contents.....	43
11. Certification	44
11.1 DoC Declaration	44
11.2 CE Warning.....	44
11.3 Environmentally friendly disposal	44
11.4 Appendix 1 FCC Statement	45

1. Safety

1.1 Safety Symbols

Pay close attention to the following symbols and their meanings. Failure to follow these warnings could cause damage, injury or death.

 Danger	• Not following these instructions may lead to serious injuries or death.
 Warning	• Not following these instructions may lead to major injuries.
 Attention	• Not following these instructions may lead to minor injuries.

1.2 Safety Guide



Prohibited



Mandatory



- **Do not use the product at night or in bad weather like rain or thunderstorm. It can cause erratic operation or loss of control.**
- **Do not use the product when visibility is limited.**
- **Do not use the product on rain or snow days. Any exposure to moisture (water or snow) may cause erratic operation or loss of control.**
- **Interference may cause loss of control. To ensure the safety of you and others, do not operate in the following places:**
 - Near any site where other radio control activity may occur
 - Near power lines or communication broadcasting antennas
 - Near people or roads
 - On any body of water when passenger boats are present
- **Do not use this product when you are tired, uncomfortable, or under the influence of alcohol or drugs. Doing so may cause serious injury to yourself or others.**
- **The 2.4GHz radio band is limited to line of sight. Always keep your model in sight as a large object can block the RF signal and lead to loss of control.**
- **Never grip the transmitter antenna during operation. It significantly degrades signal quality and strength and may cause loss of control.**
- **Do not touch any part of the model that may generate heat during operation, or immediately after use. The engine, motor or speed control, may be very hot and can cause serious burns.**



- **Misuse of this product may lead to serious injury or death. To ensure the safety of you and your equipment, read this manual and follow the instructions.**
- **Make sure the product is properly installed in your model. Failure to do so may result in serious injury.**
- **Make sure to disconnect the receiver battery before turning off the transmitter. Failure to do so may lead to unintended operation and cause an accident.**
- **Ensure that all motors operate in the correct direction. If not, adjust the direction first.**
- **Make sure the model flies within a certain distance. Otherwise, it would cause loss of control.**

2.Introduction

This product uses the 2.4GHz Third Generation AFHDS 3 protocol. The NB4 and FGr4S/FGr4 constitute a system, compatible with model cars, boats and other models. and it also supports the USB simulator function (Default enabled).

2.1 System Features

AFHDS3 (third-generation automatic frequency hopping digital system) is a newly developed digital wireless system. It is compatible with single antenna bidirectional real-time data packet transmission and data stream transmission. With the advantages that come with the WS2A wireless system and the new 2.4GHz chip, the system can dynamically set: number of channels, channel resolution, range, anti-interference requirements and latency to meet the needs of different users.

Single Antenna Bidirectional Real-time Data Transmission	The receiver can receive data from the transmitter and the transmitter can receive data from the receiver, this includes data from sensors, such as temperature and speed and support the i-BUS. This gives more control over the aircraft and constant information on its current status.
Uncorrected Data Transmission	The independent uncorrected data transmission module is built into RF system; it can send many different types of data including flight control data.
Intelligent RF configuration	Depending on hardware, certification, the amount of data to be transmitted, anti-interference, latency and distance requirements, the system intelligently adapts the corresponding RF configuration to meet the requirements of the user.
Multi-channel Frequency Hopping	This systems bandwidth ranges from 2.402GHz to 2.480GHz. This band is divided in 140 channels. Each transmitter hops between 16 channels (32 for Japanese and Korean versions) in order to reduce interference from other transmitters.
Unique ID Recognition System	Each transmitter and receiver has it's own unique ID. Once the transmitter and receiver have been paired, they will only communicate with each other, preventing other systems accidentally connecting to or interfering with the systems operation.
Low Power Consumption	The system is built using highly sensitive low power consumption components, maintaining high receiver sensitivity, while consuming as little as one tenth the power of a standard FM system, dramatically extending battery life.

2.2 Transmitter Overview

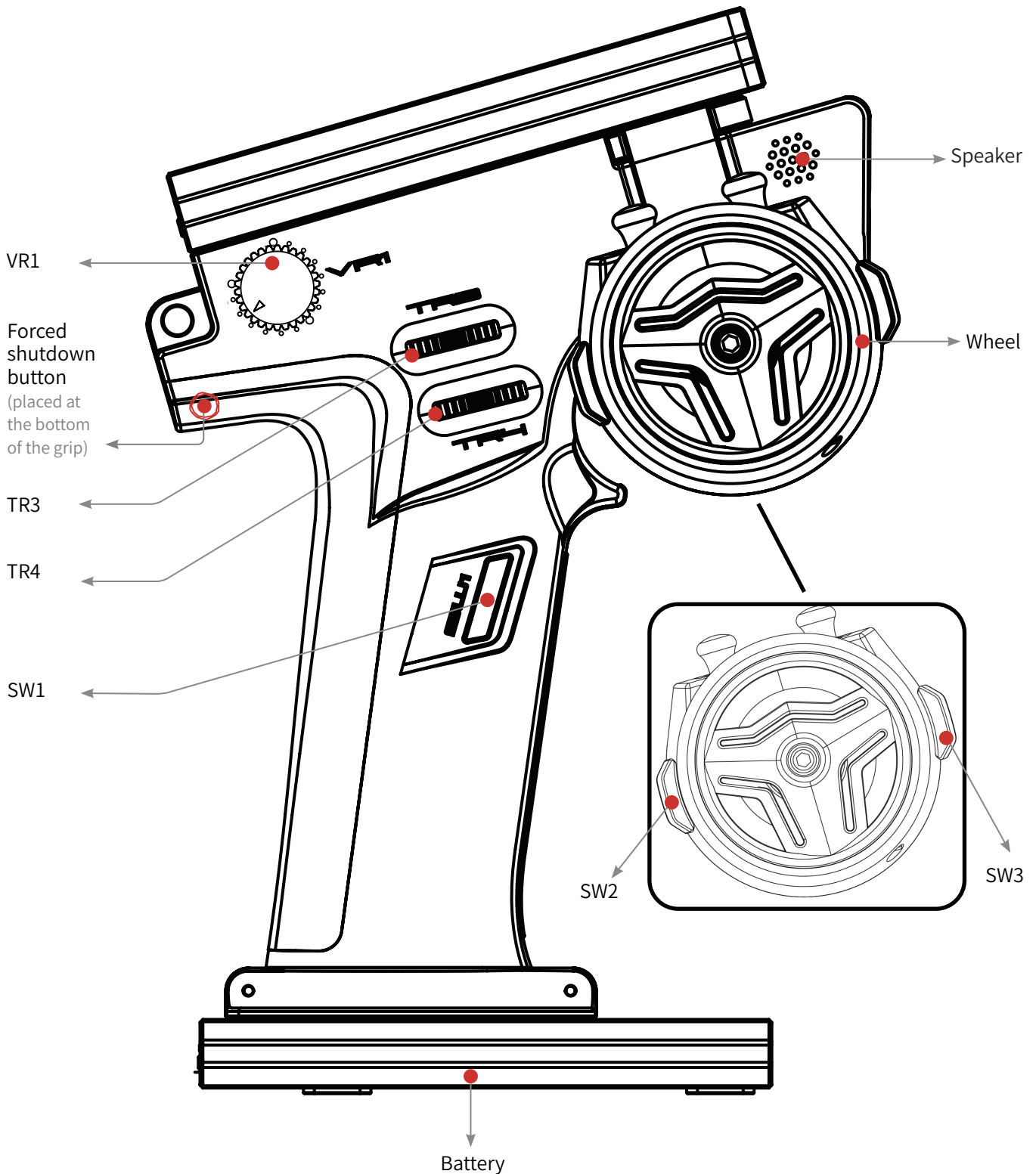

Note: If you can't shut down the transmitter properly, Please shut down the transmitter by pressing the force shutdown button on the transmitter. (Operation: pull the hand glue placed at the top of transmitter's grip or take off the whole handle glue. Use a relatively slender tool, insert the tool into the round hole on the right side of the grip, and press the forced switch button in the round hole. After pressing the button, the transmitter will be shut down immediately.)

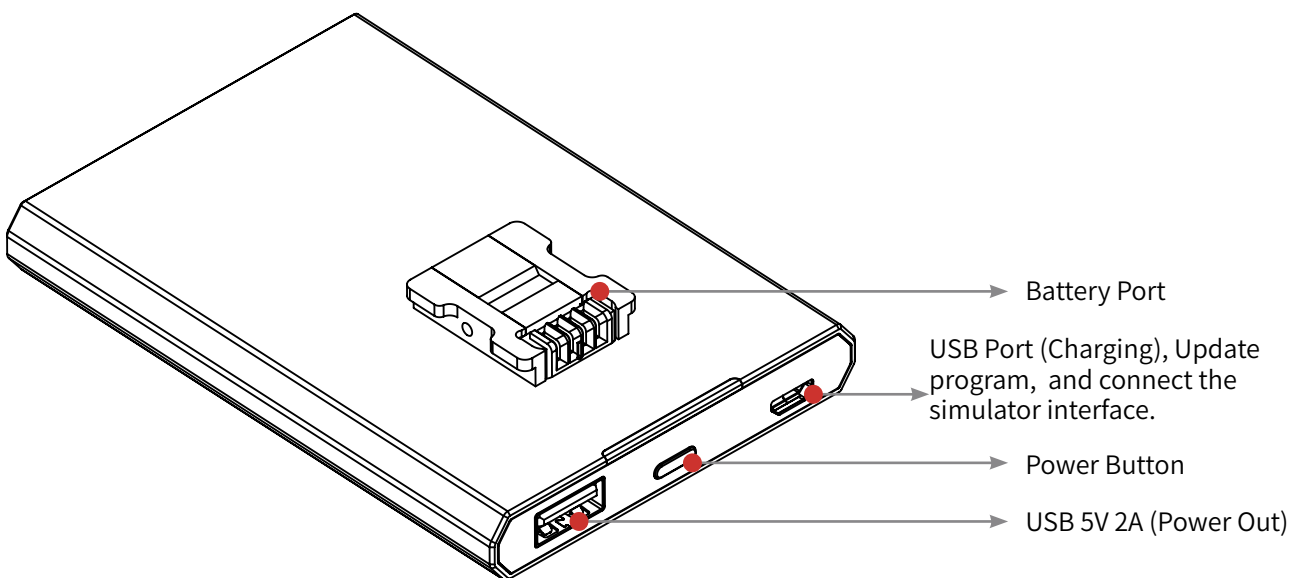
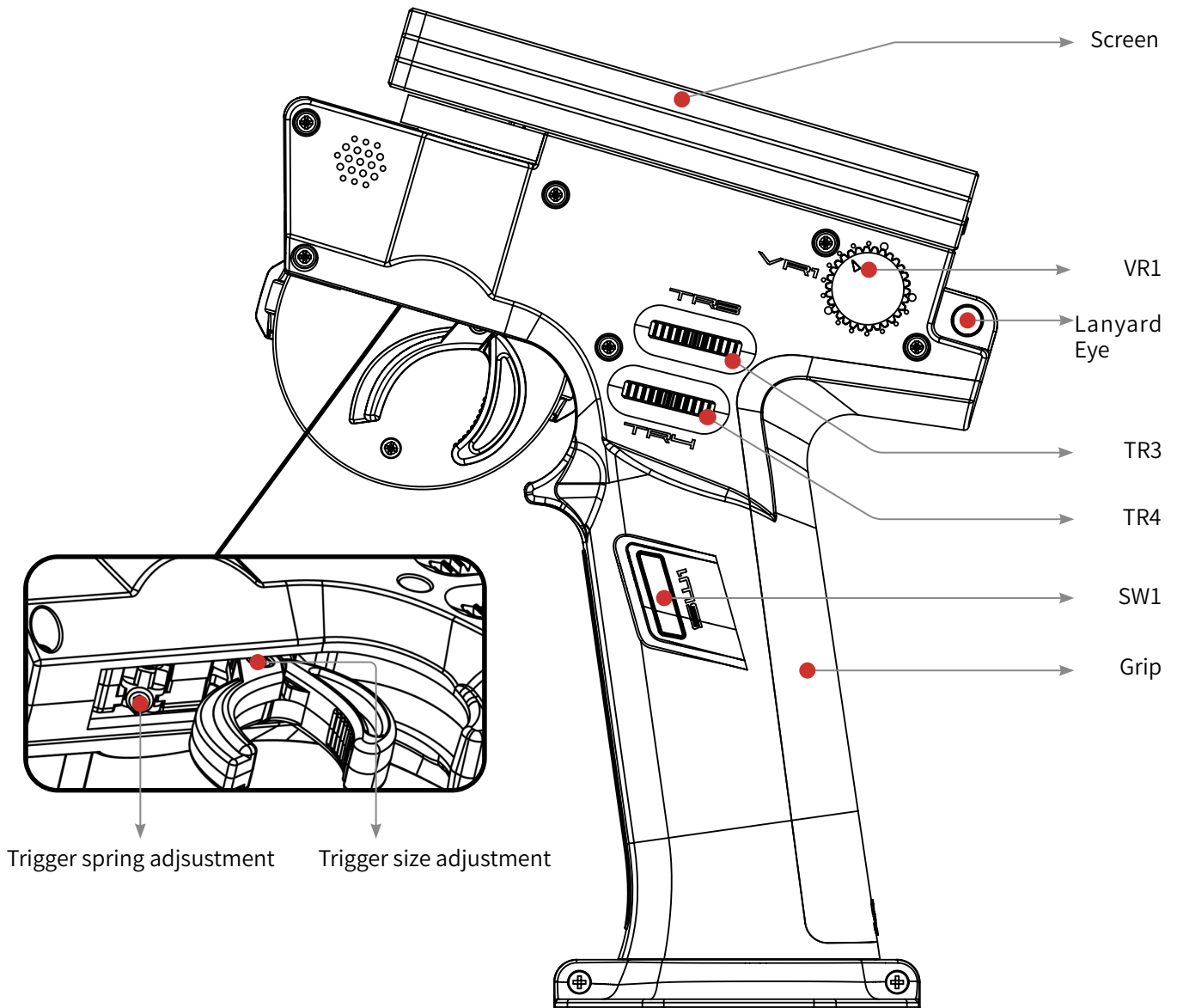

Base power button: Press for a short time to charge the battery at the transmitter handle and to charge external devices. Press 2 seconds to turn off the output of the power supply.

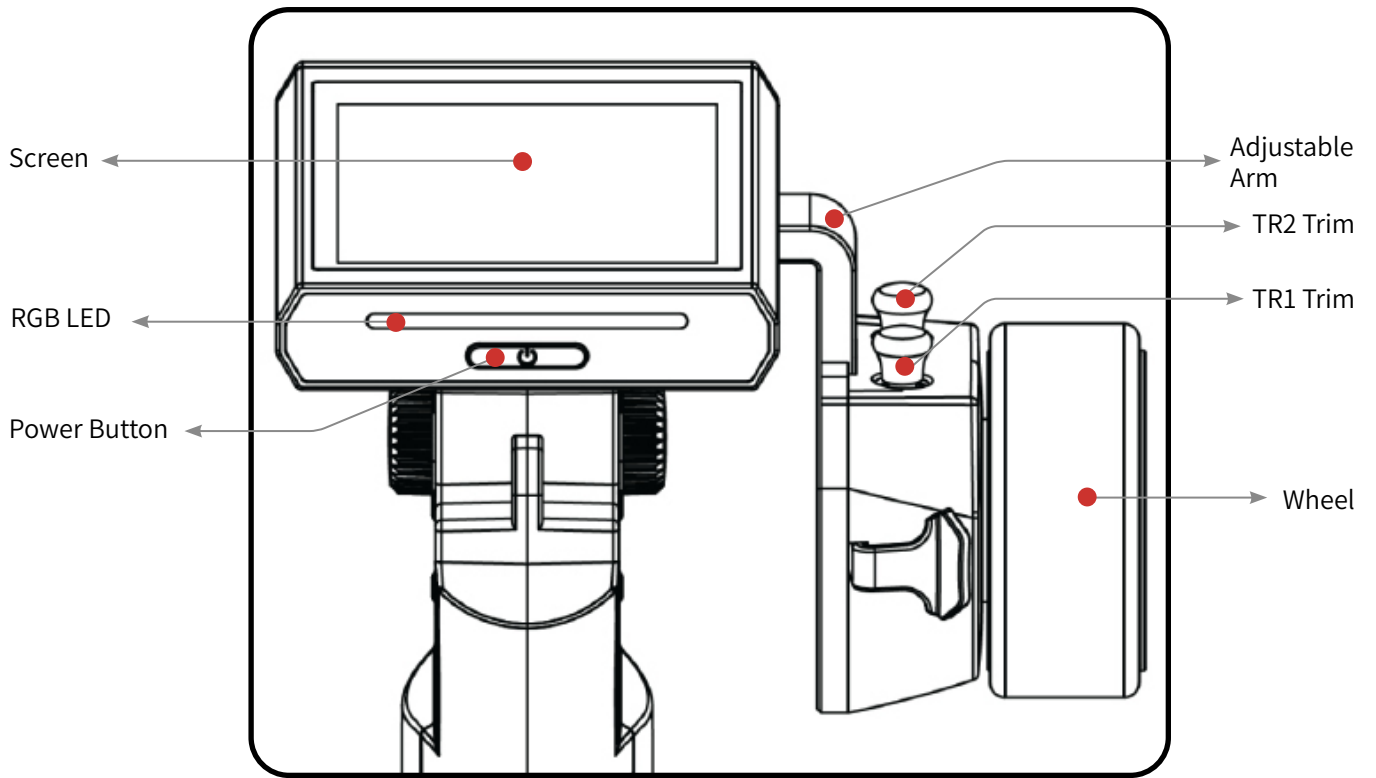

Trigger Position Adjustment Screw

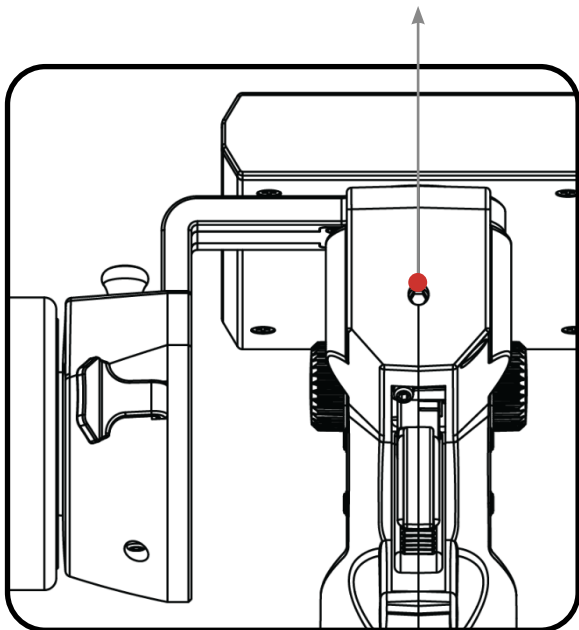

Wheel Tension Adjustment Screw

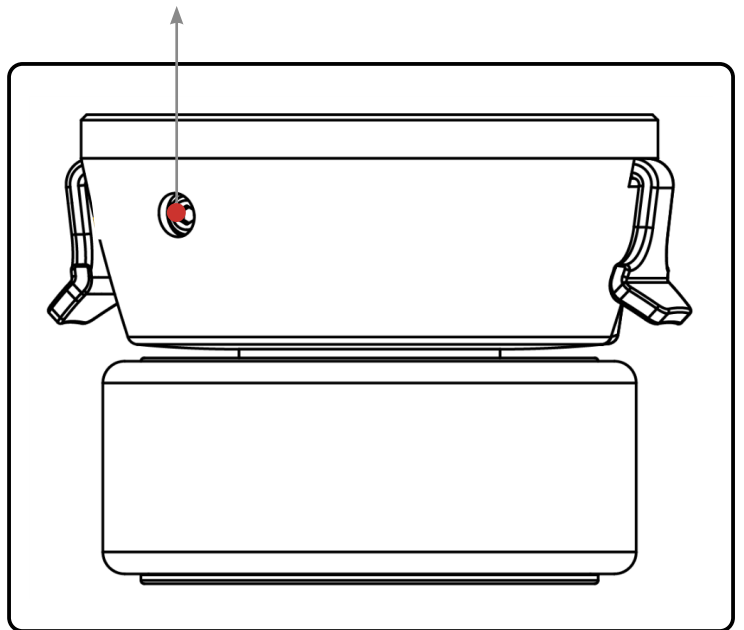

2.3 Receiver Overview

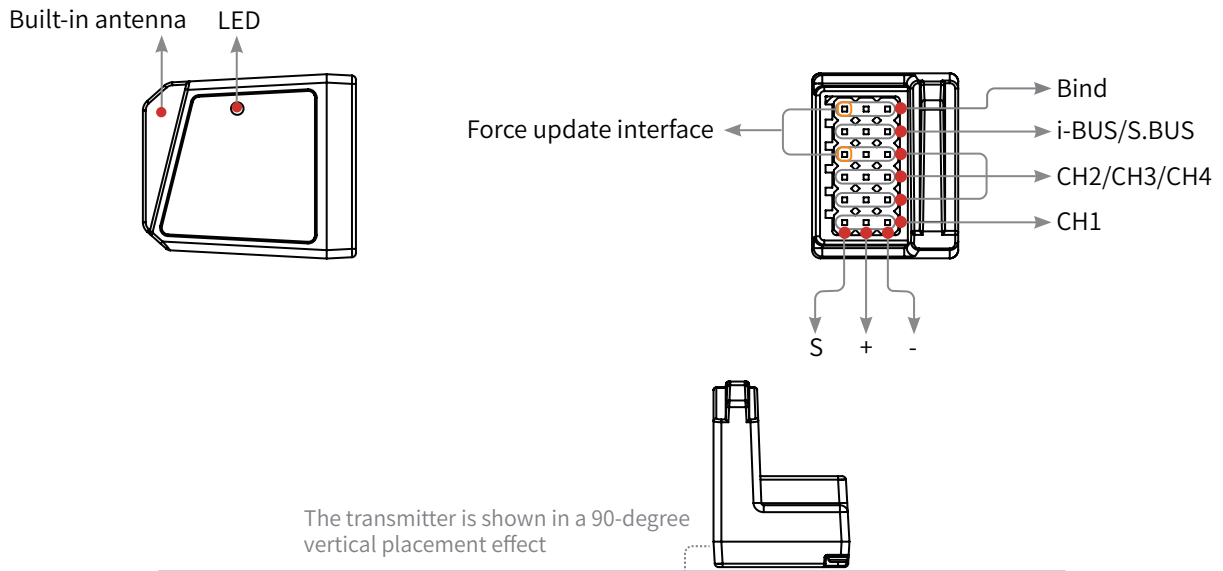

FGr4S receiver overview

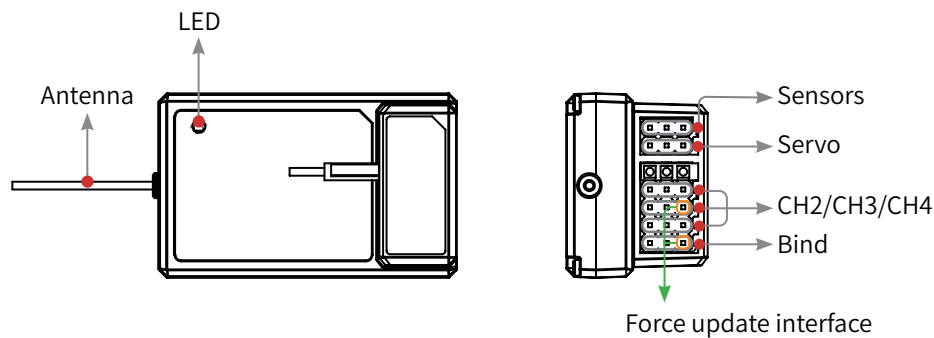

FGr4 receiver overview

For best signal quality, it is recommended to keep the receiver antenna up (as shown above) and away from metal when installing the FGr4S/FGr4 receivers.

2.3.1 Status Indicator







The status indicator is used to indicate the power and working status of the receiver.

- Off: The power is not connected.
- Lit in red: The receiver is on and working.
- Flashing quickly: The receiver is binding.
- Flashing slowly: The bound transmitter is off or signal is lost.
- Three flashes and one stop: The receiver enters forced firmware update.

3. Getting Started

Before operation, install the battery and connect the system as instructed below.

3.1 Transmitter Battery Installation

 Danger	<ul style="list-style-type: none">• Only use included batteries .
 Danger	<ul style="list-style-type: none">• Do not open, disassemble, or attempt to repair the battery.
 Danger	<ul style="list-style-type: none">• Do not crush/puncture the battery, or short the external contacts.
 Danger	<ul style="list-style-type: none">• Do not expose to excessive heat or liquids.
 Danger	<ul style="list-style-type: none">• Do not drop the battery or expose to strong shocks or vibrations.
 Danger	<ul style="list-style-type: none">• Always store the battery in a cool, dry place.
 Danger	<ul style="list-style-type: none">• Do not use the battery if damaged.

The NB4 has 2 batteries, one located in the handle and one in the removeable base.

To attach the base:

1. Line up the base so that the transmitter handle has a slight over hang on the back.
2. Carefully insert the base contacts into the hole in the bottom of the handle.
3. Hold the handle firmly and pull the battery backwards. When it is secure you should hear a click.



4. Operation Instructions

After setting up, follow the instructions below to operate the system.

4.1 Power On

Follow the steps below to turn on the transmitter:

1. Make sure that:
 - The battery is fully charged and installed correctly.
 - The receiver is installed correctly and powered on.
2. Hold the power button until the screen turns on.
3. Connect the power supply to the receiver.

 Note	<ul style="list-style-type: none">• Operate with caution in order to avoid damage or injury.
 Note	<ul style="list-style-type: none">• Make sure that the throttle is at its lowest position and the switches are set to their up position.

4.2 Binding

Ex-factory bind setting between transmitter and receiver is completed successfully. If you need to re-bind them, please follow the following steps.

1. Receivers equipped with AFHDS3 come in classic edition and enhanced edition. Models of classic edition: FGr4, FGr4S, FGr4P, FTr4, FTr10 and FTr16S (there will be pop-up menus). Models of enhanced edition: FGr4B, FGr8B, FGr12B, FTr8B, FTr12B, GMr and TMr. When AFHDS3 duplex is selected for RF standard: the receiver indicator is constantly on if binding is successful, and the transmitter automatically exits the bind interface. When AFHDS3 simplex is selected for RF standard: the receiver indicator flashes slowly if binding is successful. Click it to exit the bind interface.
2. User needs to choose between classic and enhanced editions when binding.

Binding steps:

1. Start the transmitter and enter [RX Set]. Click [Bind Set] and select classic or enhanced receiver. Click [Start Bind] to enter binding state;
2. Wait for the receiver to enter the binding state;
3. After binding is completed, check the receiver if the servo works normally. To rebind, repeat the steps above.

Notes: 1. If the enhanced receiver is selected, you can choose the [Two receiver mode] in this interface. The default is single receiver mode. In this mode, you have only to set the start channel and click [Start Bind] to enter binding state. In dual receiver mode, you need to tick the dual receiver mode first, set the start channels of the primary and secondary receivers respectively, and then click "Classic receiver" and "Enhanced receiver" to enter binding state.

2. The default start channel of the primary receiver is "Steering", and that of the secondary receiver is automatically adjusted according to the number of channels of the transmitter. For example, if the transmitter has 4 channels, the default start channel of the secondary receiver is "Steering"; when there are more than 4 channels, CH5 is the default start channel.

3. Different receiver models are slightly different in binding operation. Please refer to the receiver's manual for specific steps.

- The products are subject to constant update. Please enter FLYSKY website for the latest transmitter and receiver compatibility form.

4.3 Transmitter LED Indicator

This LED has five colors, red, green, blue, yellow, white and off which can be set according to user preference. You can also check the battery indicator. The transmitter LED can also be used as a power indicator.

To change the LED color see the LED Strip section of this user manual.

4.4 Power Off

Follow the steps below to turn off the system:

1. Disconnect the receiver power first.
2. Hold the transmitter power button until the screen turns off.



Danger

- Make sure to disconnect the receiver power before turning off the transmitter. Failure to do so may lead to damage or serious injury.

5. System Interface

The main interface mainly displays information related to the model, such as transmitter voltage information, function status and so on.

The display on the main interface can be customized as required, including the states and data of the main interface. Up to 8 states and data can be displayed.

Main interface left slide: Channel display; right slide: Failsafe; upward slide: Timer; downward slide: System settings. If you need to change settings, click [8.7 Main Interface Shortcut].

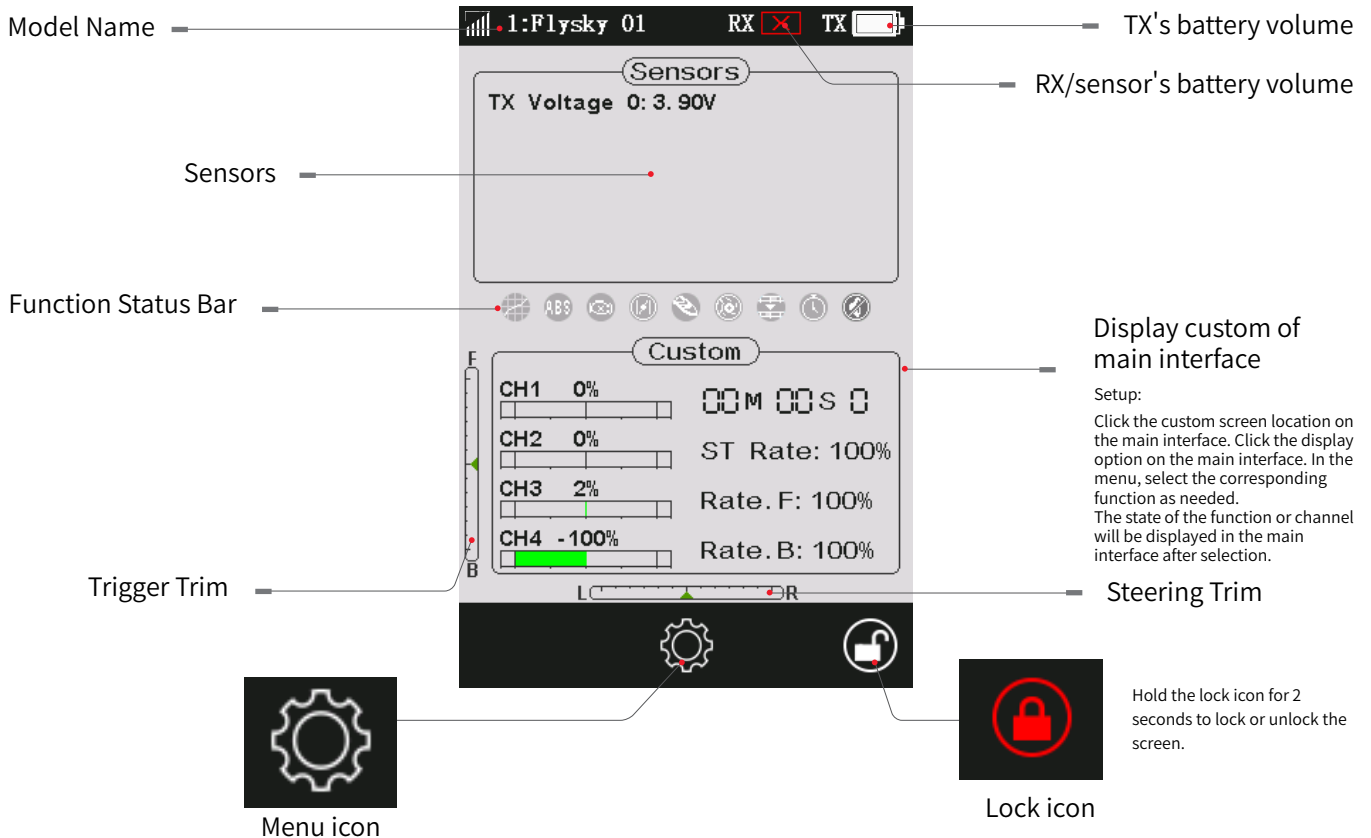

Function Status Bar

The function status bar displays the status of various functions. If the function is a darker color then it is active, if it is slightly see through then it is inactive.

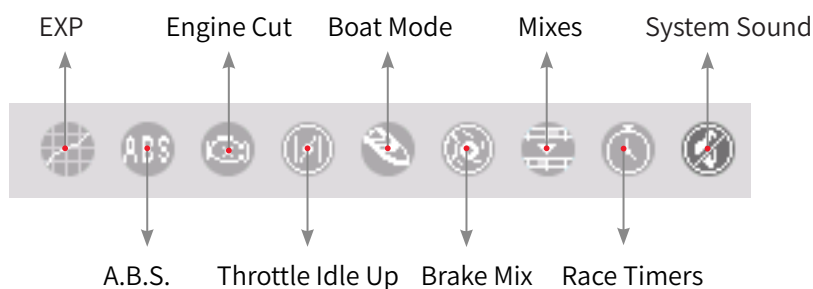

Function is not active, touch this icon, or assign activation to a switch to activate the function.



Function is active, touch this icon or assign activation to a switch to turn the function off.

6. Function Settings

Notes: 1. The default ex-factory state of this transmitter allows the user to set the functions under CH1-CH4. To set the functions under other channels, select CH6 or CH8 in Model Settings > Channel Number Definition, and follow the steps for specific function settings.

2. Some functions are disabled by default, and you may need to click and enable the function for the setting to take effect.

3. The function menus may vary with the receiver protocols. The actual product menu shall prevail.

6.1 REV

The Reverse function is used to correct a servo or motor's direction in relation to the systems controls. For example, if a steering servo is mounted upside down in order to fit inside a model, when the system's steering wheel is turned, the servo will move in the opposite direction. To fix this, all we need to do is reverse CH1.

Use:

1. Touch the box next to the channels name. If the channel is in normal mode the box will display "NOR", if it is reversed it will display "REV".
2. Test to make sure everything is working as expected.

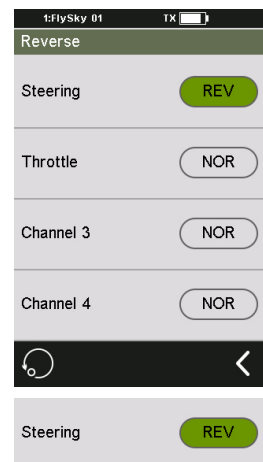

6.2 EPA

Endpoints are the limits of the channels range of movement. There are two endpoints, a low endpoint and a high end point.

Setup:

1. Touch a low or high endpoint box on a channel or move the control to the diection you wish to limit. The selected endpoint will be highlighted in green.
2. Use the + and - keys to change the end point position. The maximum is 120% and minimum is 0%.
3. Test to make sure everything is working as expected.

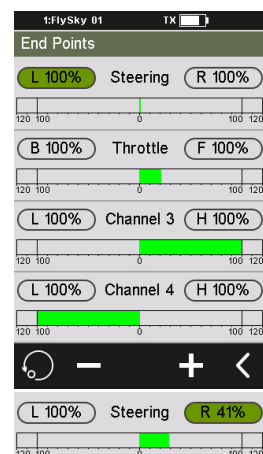

6.3 SUB TR

Subtrim is used to change the center point for each channel. For example, if a car's wheels are slightly out of alignment, even when the transmitter wheel is not being touched, subtrim can be used to correct the alignment.

Setup:

1. Touch the box next to the channel name to select it. When selected the box will be highlighted in green.
2. Use the + and - keys to change subtrim position.
3. Test to make sure everything is working as expected.

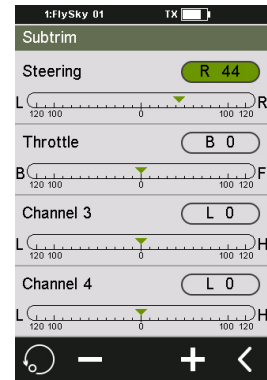

6.4 ST DR/EXP

This function changes the steering channel's response curve. There are 2 main parameters:

[Rate]: Changes the outer limits of the steering, the default and maximum is 100%.

[Exp]: Changes the steering curve, which changes the response of the steering wheel. The Exp. setting can be positive or negative.

This function can be switched on or off through SW keys, and the corresponding rates and curves can be tuned by other trims or knobs. Please refer to [Assign] function for setting.

Changes to the rate and exponential can be seen on the graph located in the center of the screen. The system also gives a real-time readout of the channel's current position.

Setup:

1. Touch [rate] or [EXP](When an option is selected it will be highlighted).
2. Use the + and - icons to raise or lower the percentage as needed.
3. Repeat for the other setting as needed.
4. Test to make sure everything is working as expected.

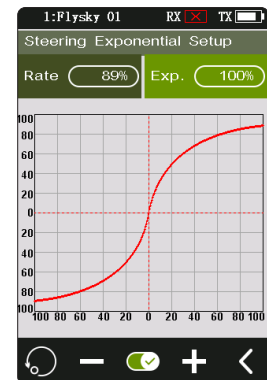

6.5 TH DR/EXP

This function changes the throttle channel's response curve. There are 2 main parameters:

[Rate.F] and [Rate.B]: Reducing the rate shrinks the outer limits of the curve. As the rate drops below 100%, the graph will update in real-time. The maximum is 100%.

[Exp.F] and [Exp.B]: Changes the steering curve, which changes the response of the throttle. The Exp. setting can be positive or negative.

This function can be switched on or off through SW keys, and the corresponding rates and curves can be tuned by other trims or knobs. Please refer to [Assign] function for setting.

Changes to the rate and exponential can be seen on the graph located in the center of the screen. The system also gives a real-time readout of the channel's current position.

Setup:

1. Touch [Rate.F], [Rate.B], or [Exp.F],[Exp.B].
2. Use the + and - icons to raise or lower the percentage as needed.
3. Repeat for the other setting as needed.
4. Test to make sure everything is working as expected.

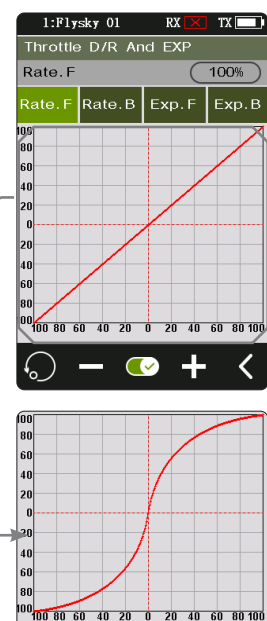

6.6 ABS



A.B.S. stands for auto breaking system. This function is used to stop the wheels from locking which can lead to loss of control or a skid. A.B.S. manages this by regulating the amount of pressure the breaks use, which is done by pumping the breaks on and off rather than a constant force.

There are six sub menus for A.B.S. function setting, [Brake Return], [Delay], [Cycle Length], [Trigger Point], [Duty Cycle], and [Steering Mix].

In the submenus, pulses are shown as a square wave, the peaks indicating brake on, and troughs in-dicating reduction in braking. As the value changes, the square wave will change to represent the function's current settings.

The trigger point is represented as a white line on the graph.

Below the graph is a bar that shows the real-time braking position. When this function is active and the brake is applied, the green bar will oscillate in real time showing the A.B.S. in action.

To activate this function press the  icon. The icon will change to  when active.

Break Return

Controls the reduction of braking during each pulse. Can be set to any value between 0% and 100%. By default it is set to 50%. If set to 60%, when the brakes are active; the system will remove 60% of the brakes strength on each pulse.

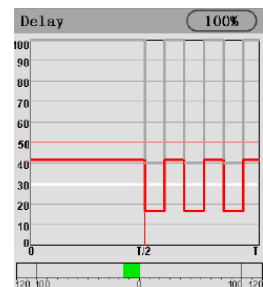
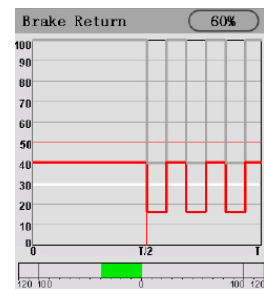
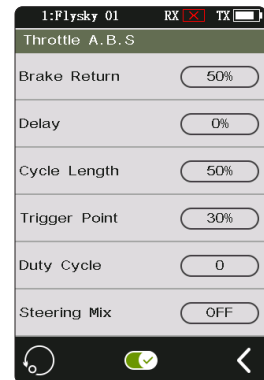

Delay

Determines how long it takes for the A.B.S. system to take effect. At a setting of 0%, the A.B.S. system will take effect as soon as the brake is applied. The higher the value, the longer it will take for the A.B.S. to function.

When set to 0% there will be no delay, meaning the breaks will be applied as soon as they are triggered. The maximum setting of 100% will result in a delay of 2 seconds.

Cycle Length

Increases or decreases the time between pulses. The higher the value, the longer the pulse.

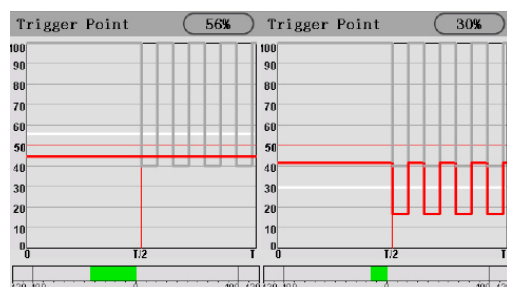
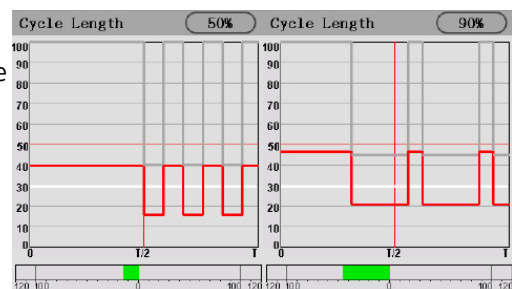

Trigger Point

Configures the point at which the A.B.S. starts to function. The higher the percentage, the further the trigger has to be moved to activate the A.B.S. 0%-100% represents the entire stroke of breaking servo.

Duty Cycle

Changes the length of each pulse and the gap between them. Adjustment range is from -4 to +4 cycles. As the value changes, the length of the braking waves peaks and troughs will change independently of each other and will no longer be symmetrical.

Adjusting the brake to release ratio

When the period is set to "0", the ratio is 1: 1;

When the period is set to "1", the ratio is 1: 2;

When the period is set to "-1", the ratio is 2: 1.

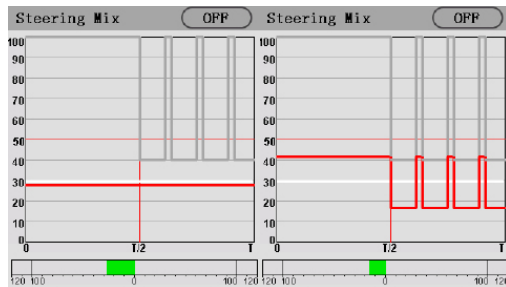
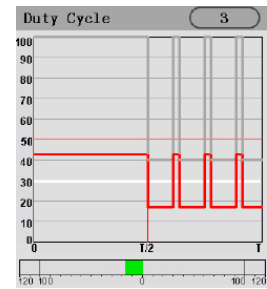

Steering Mix

A.B.S. can be reduced automatically while turning. This function mixes braking and steering to turn reduce the A.B.S. or replace it with a constant braking pressure.

The percentage represents the trigger position through its entire range of movement. E represents inside, N represents outside; if 50% N is set, the ABS function is active when within 50% (10% N-50% N), and outside 50% (50% N-100% N) is to turn off the ABS function;

If 50% E is set, the ABS function will be turned off within 50% (10% E-50% E), and the ABS function will be turned on outside 50% (50% E-100% E).

Setup:

1. Touch the enable function icon to enable this function.
2. Touch a setting to select it.
3. Touch the "+" or "-" icons to change the value.
4. Repeat as needed.
5. Test to make sure everything is working as expected.

6.7 Timer

This function can set with a variety of timers, to generally calculate the total model run time, competition specific time spent, or transmitter run time, etc.

The function can be enabled, disabled or cycle-counted by SW keys, and the timer can be reset at one touch. Please refer to [Assign] function.

The timer function can be activated in three modes:

Mode 1:

1. Click the [Timer Mode: Up Timer] icon. Click the right side of the corresponding function as needed. Click to return to the previous level interface.
2. Click [Start] to start the timer. Click [Stop] to stop the timer. Click [Reset] to reset the single timer function to its default value.

Mode 2:

1. Click the [Throttle Start Timer] icon. Click "+" or "-" to change the throttle start value. Press the "+" or "-" icon for seconds to accelerate the throttle start value. The value change level is 1, and the level range is -100 to 100. Users can adjust it as desired.
2. Click the  icon to activate this function. The interface shows "Throttle start timer open". That indicates successful activation.

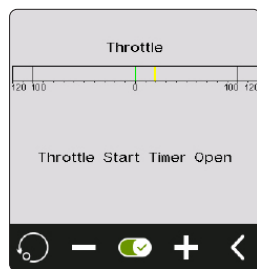

3. Verify that the settings are normal as expected. When the throttle is adjusted to the set value, the timer will start timing.

Mode 3: The timer can be enabled or disabled quickly through the key assignment function.

The system will send out a prompt once per recorded time.

The race timer has 3 modes:

[Up timer]: Counts up.

[Down Then UP Timer]: Counts down from the set time. There are intermittent voice prompts for the countdown which starts from 0.

[Lap Timer]: Keeps track time for each individual lap. Once triggered the on icon will become the lap icon. Each time the lap icon is pressed the last lap will be recorded in the lap timer list. The maximum number of laps is 99 and the minimum lap time must be over 3 seconds.

Lap Memory: Records the results from the lap timer.

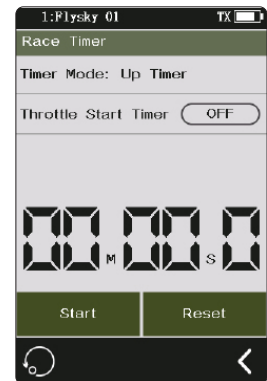
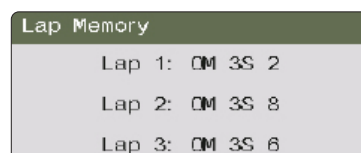

6.8 ASSIGN

The key assignment function is used to assign keys or switches to different functions for quick switch or control.

The keys of SW1L, SW1R, SW2 and SW3 can enable, disable or switch CH3 to CH18 and many functions. The combo of SW2 and SW3 can adjust the values of the selected channels and functions.

Note: The number of channels to control depends on [Channel Number Definition].

[Type]: Used for Normal and 2nd/3rd gear switch adjustment.

[Function] and [Function2]: Assign functions to this key or knob.

[Direction]: Used for the forward or reverse of this button or knob.

[Mode]: When "Trigger" is selected, channel data will change once through key triggering. Channel data will return to the state before key operation when the key is released. When "TURN" is selected, channel data remains in effect at the time of trigger if the button is rebounded.

[Step]: Step, which is used to adjust the value change of a single operation. "1" means move the key once, the value change level is 1, the level range is 1-120, the user can adjust it as needed.

Setup:

- 1.Touch [SW1-L] or any of the other button icons.
- 2.Touch [Function] to enter the next menu, Touch the icon next to function name.

If the function or channel has been assigned to another key, The system will prompt "The function is already assigned to SW2. Are you sure? Assigned to SW1-L." click [Yes] to switch.

3.Click the [NOR] option on the right side of [Direction]. Then, [REV] is displayed. It indicates the actual operation of this button is reversed with the output.

4.Click the [Trigger] option on the right side of [Mode]. Then, [TURN] is displayed. It indicates that channel data is changed once for each trigger of this button, and the data is kept in the state of the trigger is effective.

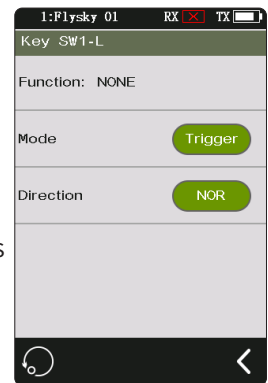
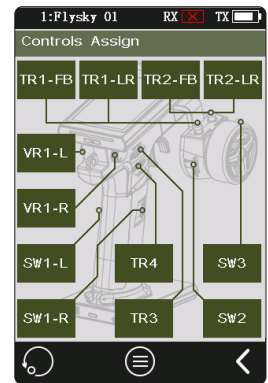

Switching to capple button:

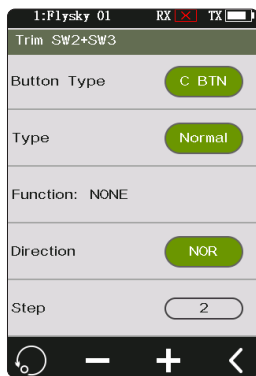

- 1.Click [SW2] or [SW3] icon to enter the submenu, then click [Button Type S BTN] to switch [C BTN].

[Button Type S BTN]: means the key or knob can control enabling, disabling, or switching from one direction separately.

[Button Type C BTN]: means the key or knob can adjust the function or channel values in two directions (upward and downward).

- 2.Click [Type], switch between [Normal], [2 POS], and [3 POS] as required,
- 3.Touch [Function] to enter the next menu, Touch the icon next to function name, and click to return to the previous interface.

A key or switch can be assigned one function or channel. When [Type] is set to [2 POS] or [3 POS], the function cannot be assigned.

4.Click the [NOR] option to the right of [Direction], and the display of [Reverse] indicates that the actual operation of this button is reversed with the output.

5. Click [Step], move the cursor to this item, click "+" or "-" to change the value. If "2" is displayed, it means to move the button once, the value change level is 2, when [Type] selects [2 POS] or [3 POS], the step value is not adjustable.

The six keys or knobs (TR1-FB, TR1-LR, TR2-FB, TR2-LR, TR3, and TR4) have the same function and can be used to quickly adjust the values of CH3 to CH8 and multiple functions, with assigning 2-position or 3-position switches. When the TR control is one-way, the assigned function and channel can be quickly enabled, disabled, or switched.

Note: the number of channels controlled is subject to the [Channel Number Definition].

The operation procedure of this function is basically the same as the SW switche setting.

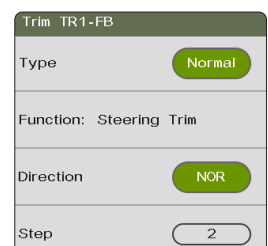

The functions of VR1-L and VR1-R are the same as above. However, the step is not adjustable.

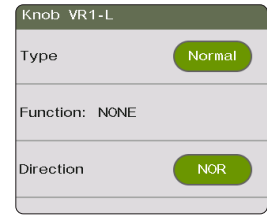

Keys Assign	
TR1-FB	Steering Trim
TR1-LR	NONE
TR2-FB	Throttle Trim
TR2-LR	NONE
TR3	NONE
TR4	NONE
VR1-R	CH3
VR1-L	NONE
SW1-L	NONE
SW1-R	CH4

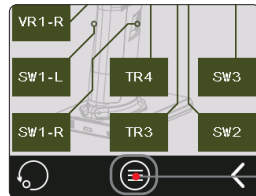

Function Assignment Icon

Click the  icon to enter the [Keys Assign]. In this list, you can view detailed information about the function assignment of all keys and knobs. You can directly click the corresponding button function to set the function.

List of assignable functions (including but not limited to the following functions):

Trim (TR1-FB/TR1-LR/TR2-FB/TR2-LR/TR3/TR4)				Switch (SW1-L/SW1-R/SW2/SW3)	
	Knob (VR1-L/VR1-2)	C BTN (SW2+SW3)			
1	Steering Trim	31	Brake 2 ABS Delay	1	Steering D/R And EXP
2	Throttle Trim	32	Brake 2 ABS Cycle	2	Steering Mix Mode
3	Steering D/R	33	Brake 2 ABS Trigger	3	Steering Mox Rear
4	Steering EXP	34	Brake 2 ABS Duty Cycle	4	Steering Mix Same
5	Steering Speed Turn	35	Mix 1 Low Side	5	Steering Mix Rev.
6	Steering Speed Ret.	36	Mix 1 High Side	6	Throttle D/R And EXP
7	Throttle D/R	37	Mix 1 Offset	7	Throttle curve
8	Brake D/R	38	Mix 2 Low Side	8	A.B.S
9	Throttle EXP	39	Mix 2 High Side	9	Throttle Idle Up
10	Brake EXP	40	Mix 2 Offset	10	Engine Cut
11	A.B.S Brake Return	41	Mix 3 Low Side	11	Brake 1 Exponential
12	A.B.S Delay	42	Mix 3 High Side	12	Brake 1 A.B.S.
13	A.B.S Cycle Length	43	Mix 3 Offset	13	Brake 2 Exponential
14	A.B.S Trigger Point	44	Mix 4 Low Side	14	Brake 2 A.B.S.
15	A.B.S Duty Cycle	45	Mix 4 High Side	15	Mix 1
16	Throttle Speed Go	46	Mix 4 Offset	16	Mix 2
17	Throttle Speed Ret.	47	Mix 5 Low Side	17	Mix 3
18	Brake Speed Go	48	Mix 5 High Side	18	Mix 4
19	Brake Speed Ret.	49	Mix 5 Offset	19	Mix 5
20	Throttle Idle Up	50	Mix 6 Low Side	20	Mix 6
21	Brake 1 D/R	51	Mix 6 High Side	21	Mix 7
22	Brake 1 EXP	52	Mix 6 Offset	22	Mix 8
23	Brake 1 ABS Return	53	Mix 7 Low Side	23	Timer Start/Stop/Lap
24	Brake 1 ABS Delay	54	Mix 7 High Side	24	Timer Reset
25	Brake 1 ABS Cycle	55	Mix 7 Offset	25	BEGINNER
26	Brake 1 ABS Trigger	56	Mix 8 Low Side	26	SVC(connect with enhanced RX)
27	Brake1 ABS Duty Cycle	57	Mix 8 High Side	27
28	Brake 2 D/R	58	Mix 8 Offset		
29	Brake 2 EXP	59		
30	Brake2 ABS Return	60			

6.9 Model

The model functions are used to change, reset, rename, copy or customize the display and sorting of the main menu. The Noble Pro can store up to 20 models.

[Select Model]: To select a model touch "Select Model", then touch a model from the list.

[Name: FlySky 01]: After clicking, use the keyboard in the interface to type in a new name.

[Channel Number Definition]: this function is used to select the number of channels. If the larger number of channels is switched to the lower number of channels, the system will prompt "The model will reset need re-binding, Are you sure?". Click "Yes". Switching is successful.

If the lower number of channels is switched to the larger number of channels, the system will prompt "After switching you need re-binding, Are you sure?". Click "Yes". Switching is successful.

Note: 1. Re-bind is required after the number of channels is changed;

2. If you do not need many channels, it is recommended to set the number of channels to 4;

3. After the number of channels is changed, the model data will be reset.

[Radio Frequency Setup]: it includes RF protocol setup and RF module update of the transmitter and receiver.

[AFHDS3 one-way]: it features lower latency, allowing one transmitter to connect multiple receivers. It is applied when the model does not need any return data.

[AFHDS3 two-way]: with the two-way return function, it can return feedback data from receivers and sensors and realize one transmitter to one receiver.

[Mini-Z(EVO)]: it is used with Kyosho FHSS receiver to control the cars of Kyosho miniZ EVO. The number of channels is fixed (two channels).

[Mini-Z(FHSS)]: it is used with a Kyosho FHSS receiver to control the cars of Kyosho miniZ FHSS. The number of channels is fixed (four channels).

FS-RM005 RF head supports a Noble Pro transmitter. It is only compatible with Kyosho Mini-Z (FHSS) cars.

Bind steps:

1. Remove the transmitter base's mobile power supply and insert the RF head into the transmitter base correctly (as shown in the figure on the right).
2. Click [MODEL]. Select the RF setting as Mini-Z (FHSS).
3. Insert it and re-install the transmitter base power supply.
4. Connect the power cord to the transmitter. Press the receiver bind key while connecting the receiver power supply. At this time, the receiver LED indicator flashes quickly.
 - Operation modes vary with receivers in case of their bind state.
5. Click [Receiver setup]. Select [Bind setup]. After the receiver flashes slowly, the transmitter will automatically exit the bind state. When the receiver indicator is on, it indicates the bind is successful.
6. Check whether the servo is working properly. If a bind is required again, repeat the above steps.

Change the RF protocol:

1. Click [RF standard] to enter the submenu. Click the right side of the corresponding function. Select "Yes" and click to return to the previous level interface after the prompt box pops up.

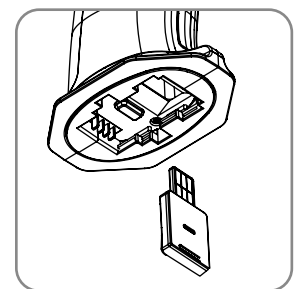
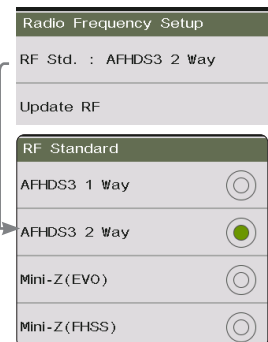

- If you switch to the RF standard, the model will be reset and a bind is required again.

[Update RF]:

The update RF function can be used to update the built-in RF module. After the firmware of the transmitter is updated, you need to update the RF when the system prompts that the RF fails or the bind of the receiver fails.

Click [Update RF], Click "Yes" after the prompt interface pops up. An update progress bar appears. Wait a few seconds. The update is completed. The transmitter will automatically exit the update interface. If the transmitter cannot enter the update RF status, there is no RF module or the RF module is faulty.

[Custom Main Menu]: You can customize the sort and hide functions of the main menu. To show the menu, select the check box. To hide the menu, uncheck the box. To adjust the menu order, select the menu to move (highlighted), and click [Move up] or [Move down] below to change the menu order.

Note: By default, the "Beginner Mode" function is hidden. Except for [System] and [Model], all other functions can be hidden.

[Model Reset] : To reset a model touch "Model reset", then select the model you wish to reset from the list. The system will ask if you are sure, select "yes".

[Copy Model]: Touch "Copy Model", then touch the model to copy from the list. Next select a target slot from the list, this will overwrite everything in that slot. The system will ask if you are sure, select yes.

[Import or Export Model] : You can import and export models by logging in to the FlySky official website to download the software (FlySky Assistant) and then operate it on the PC (No need go back to click the menu on the transmitter, you can operate it directly!)

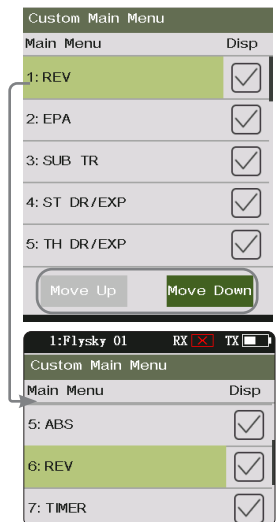

6.10 Sensor

This list shows all sensors connected to the receiver, including sensor type, number and real-time data. This list can also be accessed quickly from the home screen.

[Display Sensors]:

This list shows all sensors connected to the receiver, including sensor type, number and real-time data. This list can also be accessed quickly from the home screen.

[Type] shows the sensor type.

[ID] display sensor's number.

- The number zero in the list by default is the TX Voltage sensor, however receiver, signal strength indication, RSSI, noise, signal to noise ratio can also take this slot.
- No. 0 is the return information of the Classic-receiver.
- No. 1 is the return information of the Enhanced-receiver.
- No. 2 is the first external sensor connected to the receive, the receiver supports up to 14 sensors.

This list data is displayed in real time. When the receiver is connected to a sensor, this list will be refreshed to display the new sensor's data.

[Value] displays the data returned by a sensor.



Type	ID	Value
TX Voltage	0	3.82V
RX Voltage	0	5.09V
Signal Strength	0	100
RSSI	0	-58dBm
SNR	0	46dB
Noise	0	-103dBm
Temperature	2	28.0°C
Motor Speed	3	0rpm
Motor Speed	4	0rpm
Ext Voltage	5	-0.01V
Air Pressure	6	998.3hPa
Altitude	6	125m

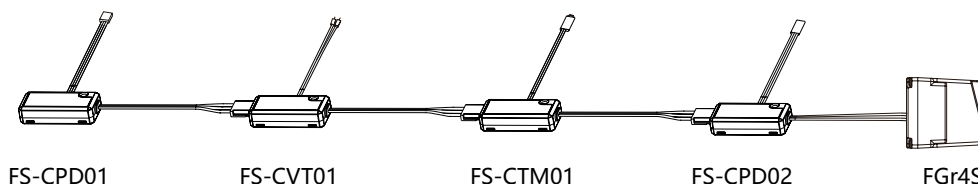

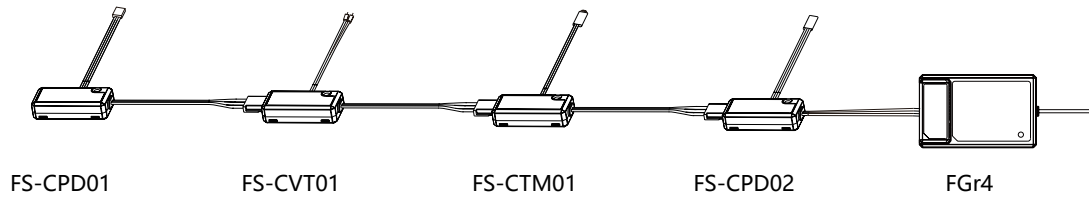

Note:

If using the Classic receivers you must select the [RX Interface Protocol] in the [RX SET] menu and select "i-BUS", save and exit, then connect the sensor to the receiver's i-bus port. All other steps remain the same.

2.If you use an enhanced receiver, you need to set the New Port interface to ibus-in.

Speed sensor (FS-CPD01, FS-CPD02)

The speed sensor is applied to test the speed of the motor.

- "Motor speed" indicates that the sensor is testing the motor speed; "0rpm" is the speed measurement value.

Magnetic induction speed sensor (FS-CPD01)

1. Connect the FS-CPD01 sensor to the SENS interface of the receiver or the IN interface of the previous sensor.
2. Place the sensor next to the magnet, which is fixed at the position of the axial rotation to be tested (e.g. inside the wheel hub of the model car).
3. Place the sensor within 2 mm of the magnet, with the south or north pole of the magnet parallel to the sensor.

Turn on the transmitter, and select [Sensor] - [Display Sensor]. Turn the gear. When the [Type] column shows "RPM" and the RPM value (0rpm) in the [Value] column changes. It indicates that installation is successful. Otherwise, repeat the above steps.

Light induction speed sensor (FS-CPD02)

1. Connect the FS-CPD02 to the relevant device, with the same connection method as above.
2. Fix the sensor and the reflective sticker at the position of the axial rotation to be tested. Keep the sticker flat and perpendicular to the sensor probe. Keep a moderate distance between the sensor probe and the sticker.
3. Turn on the transmitter, and select [Sensor] - [Display Sensor]. Turn the gear. When the [Type] column shows "RPM" and the RPM value (0rpm) in the [Value] column changes. It indicates that installation is successful. Otherwise, repeat the above steps.

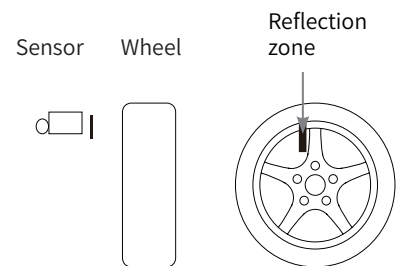
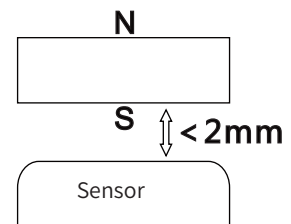
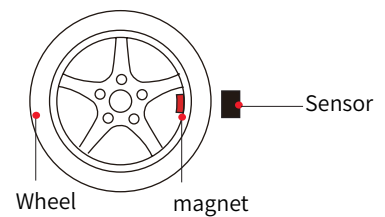

Temperature Sensor (FS-CTM01)

Used to monitor the temperature of various components. Warnings can be set.

1. Connect the FS-CTM01 to the receiver or other sensors using the same method as used with other sensors.
2. Use a spongy double-sided tape to stick the temperature probe to the part you wish to monitor (such as: motor, battery).
3. Turn on the transmitter, enter [Sensor], then [Display Sensors] and rotate the wheel. If the "Type" column displays "Temperature" and the [Value] column displays a temperature then the installation was successful, otherwise repeat the above steps.

Voltage sensor (FS-CVT01)

It is used to monitor the model's battery voltage. The battery voltage can be monitored through from the transmitter. Warnings can be set.

1. Connect FS-CPD02 following the same steps as above.
2. Insert the red and black wire pins into the plug of the battery used for testing. The red wire is the positive pole and the black wire is the negative pole. When the voltage displayed on the transmitter sensor display interface is positive, the installation is successful.
3. Turn on the transmitter, enter [Sensor] , then [Display Sensors] menu and rotate the wheel. If the "Type" column displays "External Voltage" and the [Value] column displays a voltage then the installation was successful, otherwise repeat the above steps.

[Choose Sensor]:



This function allows you to select the sensor to be displayed on the main screen and high and low alarm values for that sensor.

There are four settings under this function: [Transmitter Voltage], [Receiver Voltage], [Signal Strength] and [RSSI], for setting high and low alarm values of the corresponding sensor.

For example , the Signal Strength Indication (RSSI). It refers to the distance between the transmitter and the model determined by received signal strength. A low signal strength indicates a weaker signal received by the receiver. This may cause the model to lose signals. A high signal strength indicates that the signal received is too strong, and this may interfere with the signals of the receiver and cause the model to lose control. Therefore, users can also choose to set the strong alarm alert.

Setup:

[TX voltage]:

1. Enter this menu then touch the  icon to enable this function. When this function is enabled, the icon will change to .
 2. Touch [Low Alarm] to select. [Value] is the corresponding status alarm value. Touch the "+" or "-" icons to change the trigger value. Same with the [High Alarm] .
- [RX voltage], [Signal strength], [RSSI] can all be set using the above instructions.

Speed and distance:

This function is used to detect monitor wheel revolutions and distance traveled.

[Speed sensor]: Select the target sensor. If the sensor and receiver are connected the will appear in this menu automatically. You can choose between two speeds or [None].

[Set rotation length]: If a speed sensor is installed on the wheel, you need to define the radius the wheel. This length will be used to calculate the distance traveled. Click "+" or "-" to adjust the radius.

[Reset odometer 1]: Odometer 1 is used to record the distance traveled. The value of odometer 1 will be reset to zero each time the transmitter is power cycled.

[Reset odometer 2]: Odometer 2 is used to record the total driving distance regardless of transmitter power cycles, and as such is the cumulative distance from each session.

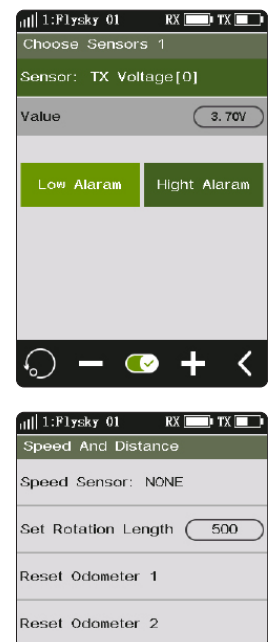

6.11 CH SPEED

This function allows you to set the steering speed, forward speed, brake speed and response speeds of CH3 to CH8.

Note: the number of channels controlled is subject to the [Channel Number Definition].

[Steering Speed]: changes the corresponding speed of the servo when the steering channel is outputting at fast speed. The minimum delay is 0.00s, and maximum delay is 10.00s. The adjustment step is 0.01s.

This function can be used for adjustment when the vehicle is operated with fast steering, which may cause the vehicle to lose control or when the vehicle structure cannot withstand a too fast steering speed.

[Front]: sets the response speed of the throttle channel.

This function can be used to imitate models with slow acceleration and deceleration response (for example, large trucks).

[Back]: used for vehicle models.

The [Steering Speed Turn], [Steering Speed Reset], [Throttle Speed Go], [Throttle Speed Reset], [Brake Speed Go] and [Brake Speed Reset] can be adjusted after assigning VR and TR keys or knobs in the [Key Settings] function. A window will pop up when you adjust the real-time value by keys.

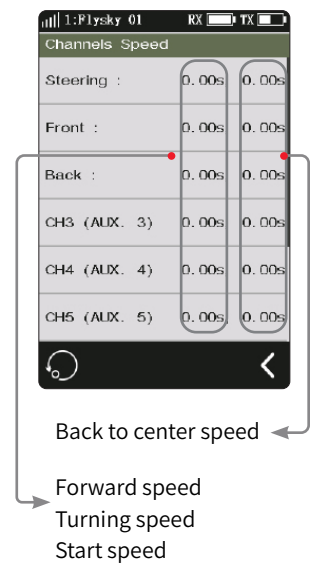

Channel speed - Steering

Function setting:

[Turn speed]: slows down channel output speed when the steering wheel is moving from the neutral position to maximum travel.

[Return speed]: slows down channel output speed when the steering wheel returns to the center position.

1. Click [Turn Speed] or [Return Speed]. This item is highlighted when selected.
2. Click the "+" or "-" icon to change response duration as needed. Press the "+" or "-" icon to accelerate the adjustment duration.
3. Verify that the settings are normal as expected.

Progress bar 1: shows the channel output speed after the delay (as shown on the right).

Progress bar 2: shows the actual speed before the delay takes effect (as shown on the right).



Channel speed-back/brack

This function is only applicable to normal mode. This function is not displayed in ship mode.

Function setting:

[Go Speed]: sets the speed of the throttle brake.

[Return speed]: sets the speed at which the throttle brake returns to the center position.

1. Click [Go Speed] or [Return Speed]. This item is highlighted when selected.
2. Click the "+" or "-" icon to change the response duration as needed. Press the "+" or "-" icon to accelerate adjustment duration.
3. Verify that settings are normal as expected.

Progress bar 1: shows the channel output speed after the delay (as shown on the left).

Progress bar 2: shows the actual speed before the delay takes effect (as shown on the left).

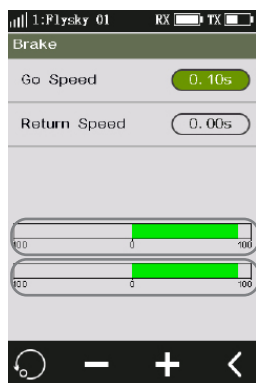

Channel speed - Front/Throttle

This function is used to set the delay of the throttle start and return-to-center.

[Go Speed]: sets the speed of throttle acceleration.

[Return Speed]: sets the speed at which the throttle returns to the center position.

Setup:

1. Click the option that needs to be set. This item is highlighted when selected.
2. Click the "+" or "-" icon to change the response time or the percentage of the corresponding point as required. Press the "+" or "-" icon to accelerate adjustment of the corresponding value.
3. Verify the settings are normal as expected.

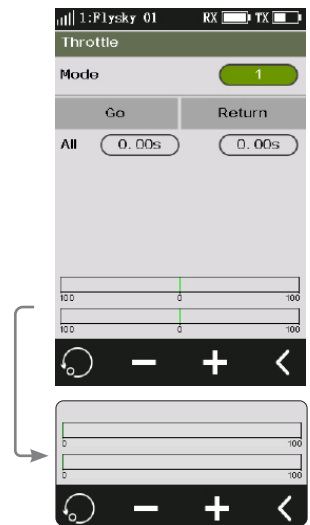

Channel Speed - CH3-CH8

This function is used to set the delay time of CH3-CH8 forward and return-to-center.

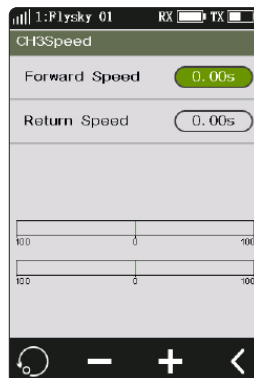

6.12 MIXES

This function allows you to set 3 mixing functions, that is, [4WS Mixing], [Brake Mixing], and [Programming Mixes].

4WS Mixing

Used to set the wheels that control steering of the vehicle, front, rear or all four wheels.

This function is applicable to crawler with steering on both front and rear wheels.

By default, the front wheel steering is used in this function.

[Mixing Rate]: sets the amount of mixing from the steering channel mixing to the mixed channel. The adjustment range is 0-100%.

Setup:

1. Click [Ch3] on the right side of [Mixing Channel]. Click the right side on the corresponding channel. After selection, the channel will be occupied. Click to return to the previous level interface.
- Each channel can only be assigned one mixing function. It is not allowed to conflict with other Func Assign channel. When the selected channel is assigned with other mixing functions, the system will give a pop-up window reminder.
2. Click the "+" or "-" icon to change the ratio as required. Press the "+" or "-" icon to accelerate the ratio adjustment.
3. Select the steering type as required. You can select [Steering Mix Mode] in the [Assign] function, and assign SW keys to switch four different functions. Alternatively, you can select [Steering Mix Rear], [Steering Mix Same] or [Steering Mix Reverse], to realize fast switch between this function and [Steering Mix Front] through SW key.
4. Click the icon to enable this function. After this function is enabled, the icon will change to .
5. Verify the settings are normal as expected.

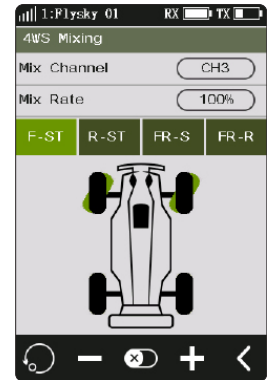

Brake Mixing

This function has two sets of brake mixing controls, to use multiple servos to control brakes; for example, models using different servos to control the front and rear brakes.

If your model uses multiple channels to control the brakes together, you can use this function to control the brake channel as a mixer channel for the throttle channel.

Setup:

1. Click [Brake Mixing 1: Off] option to enter the submenu.
2. Click [CH3] on the right side of [Mix Channel]. Click the corresponding channel on the right side as needed. This channel will be occupied after selection. Click to return to the previous level interface.
- Each channel can only be assigned one mixing function. It is not allowed to conflict with other Func Assign channel. When the selected channel is assigned with other mixing functions, the system will give a pop-up window reminder.
3. Perform the settings by following the steps of setting the [EXP] and [ABS] function.
4. Use the servo display function. Verify that the settings are normal as expected.

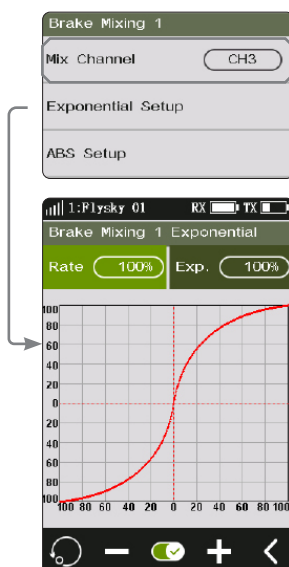

You can select the menu corresponding to brake mixing in [Key Settings], and assign VR, TR key or knob for adjustment. A pop-up window will appear to show the real-time value during the adjustment by key. Select [Brake 1 EXPs], [Brake 1 A.B.S.] or [Brake 2 EXP], [Brake 2 A.B.S.] to assign SW keys for fast enable/disable of two sets of brake mixing functions.



Programming Mixes

The Mixing function can be used to set the mix-control relationship between channels, containing a total of 8 groups of mixing relationships.

Setup:

1. Click [Mix 1] or other mixing options as needed to enter the setting interface.
2. Click the  icon to enable this function. When this function is enabled, the icon will change to .
3. Click [Master Channel], select a primary channel from the list. The primary channel will affect the secondary channel.
4. Click [Slave Channel] and select a secondary channel from the list.
5. Select [Low Side Mix] or [High Side Mix] as needed. Click the "+" or "-" icon to change the percentage to adjust the amount of low end or high end mixing. Click the  icon to return to the menu when the setting is complete.
6. Click [Offset]. Then click the "+" or "-" icon to change the offset associated with the primary channel and the secondary channel.
7. Repeat the above operations to set other mixing controls.

Assign VR, TR keys or knobs in the [Assign] function to adjust 8 groups of programmed mixing controls of [Low Side Mixing], [High Side Mixing] and [Offset] ratios. A pop-up window will appear in the adjustment by pressing the key, prompting real-time value. In addition, it is possible to quickly enable or disable Mix 1 to Mix 8 functions by using the SW key.

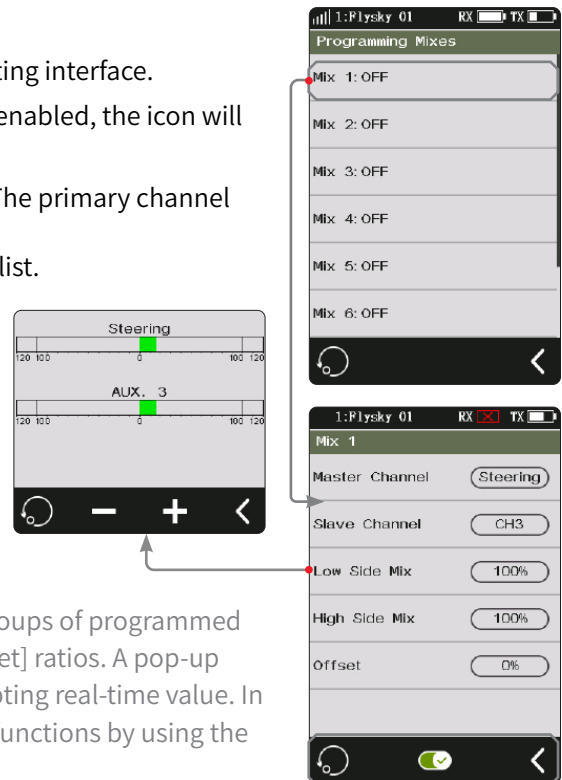

6.13 Throttle Middle

The throttle middle function is used to set the neutral position of the throttle and brake to correct the problem of unequal throttle travel and brake travel of some models. If the neutral position is not set correctly, the model may start acceleration and driving directly after power-on.

Setup:

1. Click the "+" or "-" icons to change the percentage as needed.
2. Verify the settings are normal as expected.

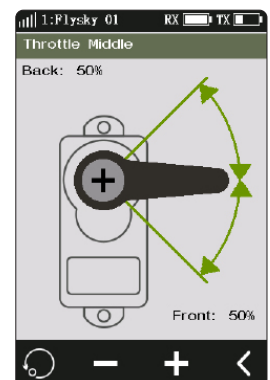

6.14 TH Neutral

Throttle Neutral creates a configurable dead zone for the throttle channel.

[Forward]: How far the dead zone extends into the throttle zone.

[Dead Zone]: The point at which the channel will kick in when the trigger passes the threshold.

[Backward]: How far the dead zone extends into the braking zone.

Setup:

1. Touch "Forward", "Dead Zone" or "Backward" to select it.
2. Use the + and - icons to change the percentage as needed.
3. Repeat with other settings as needed.
4. Test to make sure everything works as expected.

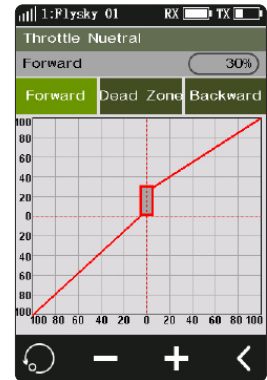

6.15 TH Curve

The throttle curve function is used to adjust the response speed of the throttle at different positions. By default, it is disabled and the throttle curve is output linearly.

Setup:

1. Assigned a switch for throttle curve in the function of [ASSIGN];
2. Touch the icon to enable the function. The icon will change to when enabled.
3. Touch a point.
4. Use the + and - icons to raise or lower the points position as needed.
5. Repeat for the other points as needed.
6. Test to make sure everything is working as expected.

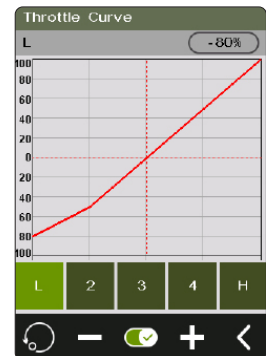

6.16 Idle Up

Throttle Idle Up is used for models that use a fuel based engine that will stall.

If left at 0 throttle. Idle up makes sure that the engine always has some throttle in order to keep it from stalling.

This function must be assigned to a switch/button in order to be activated .

This function will reset after shutting down. You need to restart this function after turning on again.

Setup:

1. Click the icon to enable this function. When this function is enabled, the icon will change to .
2. The system jumps to the [Key Setting] function (please refer to [6.8 Assign] function to assign corresponding switch for this Function Assign).
3. Click the "+" or "-" icons to change the percentage as needed.

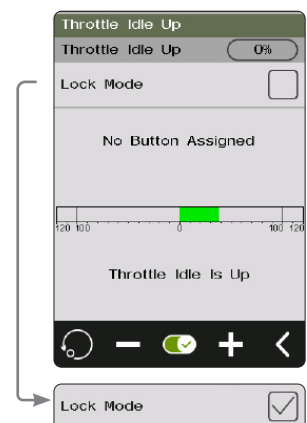



6.17 ENG CUT

When Engine Cut is triggered via a button it sets the throttle channel to a predefined position.

This function must be assigned to a switch/button in order to be activated.

This function will reset after shutting down. You need to restart this function after turning on again.

Setup:

1. Click the  icon to enable this function. When this function is enabled, the icon will change to .
2. The system jumps to the [Assign] function (please refer to [6.8 Assign] function to assign the corresponding switch for this Func Assign).
3. Click the "+" or "-" icons to change the percentage as needed.

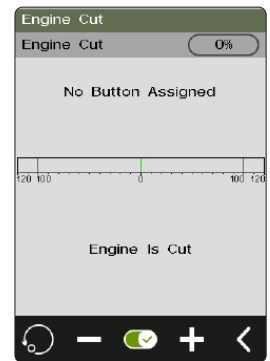

6.18 Boat

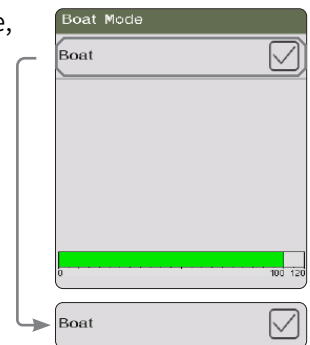

This function is used only when you are using a model boat. When this function is active, the throttle channel is set to its lowest position and the brake functionality is disabled.

To enable this function, select [Boat] to switch to boat mode. When switching is successful, [Normal Mode] is changed to [Boat Mode]. The check box is selected.



6.19 Display

This function displays the model's channel output and can be used to test output and servo range.

Press the icon  to start servo test mode, which will move all the channels slowly through their entire range of motion. Press the  icon to turn off servo test mode.

WARNING • Make sure the model engine is powered off while the test function is activated.

Click the  icon to enter the channel display interface. In this list, you can view the data progress bar of all channels and the percentage data of channels.

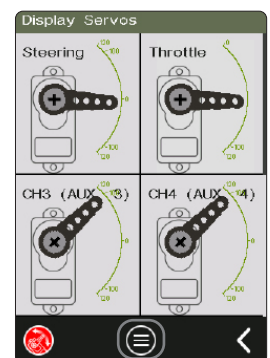



6.20 Beginner

The beginner mode is suitable for entry level players to improve the safety of operations by limiting the amount of throttle servo.

This function is hidden by default. You need to enable it manually.

Setup:

1. Go to the [Custom Main Menu] menu under the [MODEL] menu bar, and select the [Beginner] check box. After selection, this function is displayed on the menu interface.
2. Find the function in the menu and click  icon to enable this function. When this function is enabled, the icon will change to .

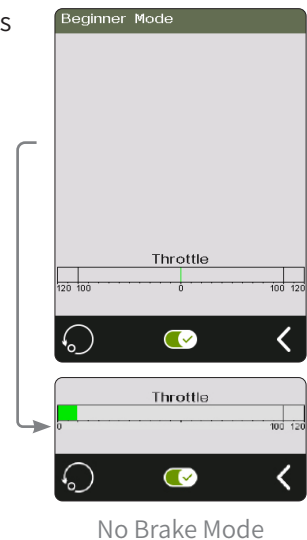

6.21 SVC

The receivers configured with this function are INR4-GYB (built-in gyroscope) and GMR (with gyroscope interface).

[Neutral Calibration]: used for gyroscope to calibrate steering and throttle neutral to make the best driving condition when the vehicle is driving normally.

- Before enabling the intelligent vehicle control function, you need to adjust the vehicle's steering servo volume, neutral trim and throttle neutral to the best driving condition. After completion, start the [Smart Vehicle Control] function for neutral calibration. Every time you change the trim or throttle curve, you need to calibrate the neutral position. The steering throttle should be placed in the neutral stationary state during the calibration process.

[Reverse]: You can set the positive and negative direction of the gyroscope in the mix-control of the direction channel.

[ESP Mode]: used for model assisted stability. Two modes are available: normal/lock.

Normal: when the vehicle is yawing or steering, the gyroscope automatically provides an opposite compensation to control the servo to keep it stable or prevent drifting according to the angular velocity generated.

Lock: if the steering wheel is return-to-center, the gyroscope will control the servo in the opposite direction according to the yaw angle when the vehicle is yawing, to make it go back to the expected direction (if the steering wheel is not return-to-center in the "Lock mode", it will be the same as the "Normal mode").

[Steering Gain]: is used to change the sensitivity of the mixing direction.



[Throttle Gain]: is used to change the mixing throttle sensitivity.

[Priority]: used to set the control ratio between steering wheel control and gyroscope in the steering, i.e., turning radius. In direction turning by using the steering wheel, the steering angle will be reduced due to the influence of gyroscope mixing. When the value is 0%, the mixing control is the strongest, that is, the turning radius is the largest. When the value is 100%, the mixing control is 0, that is, the turning radius is the smallest.

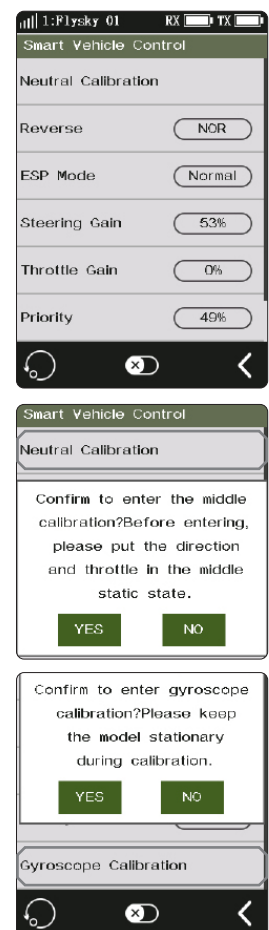
[Gyroscope calibration]: used for the first time to enable the gyroscope via binding or gyroscope calibration required after replacement. The model keeps a stable and stationary state. Click calibration. The receiver flashes twice and exits automatically. This indicates that the calibration is successful.



Setup:

1. Click the  icon to enable this function. When this function is enabled, the icon will change to .

- If the gyroscope is not connected, this function cannot be activated, and the system prompts "The current receiver is not properly connected to the gyroscope".

2. Click [Neutral calibration]. A pop-up box will appear "Are you sure you want to enter neutral calibration? Put the steering and throttle in the neutral stationary state before entering". Click "Yes". The transmitter enters the calibration state. The system prompts successful calibration with sound reminder.

3. If you want to change the direction of action, please click [Reverse]. If the function is set to reverse, it will show "Reverse";

- The method of replacing EPS is the same as above.

4. Under this function, you can also set the percentages of [Steering Gain], [Throttle Gain], and [Priority]. The adjustable percentages range is 0% to 100%. After selecting the option, click the "+" or "-" icon to change the percentage.

5. Slide to the bottom on the interface. Click [Gyroscope calibration]. A pop-up box will appear, indicating "Are you sure you want to start the calibration". The system prompts successful calibration with sound reminder.

When calibrating the gyroscope, please make sure the model is in a stable and stationary state.

6.22 Help

To obtain the user manual via this function. Users can contact us through social accounts listed on the interface.

Setup:

1. Touch [Help center] to enter.
2. Touch the item you want to view, then the corresponding QR code will display.
3. Scan the QR code to obtain the related information. Then click  to return to the previous interface.

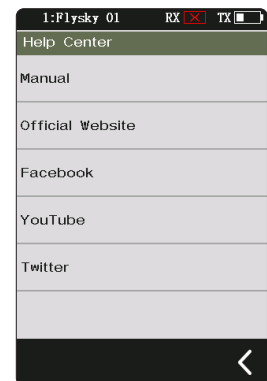

7 RX SET

7.1 Bind Set

This function is used to adjust the transmitter to the bind state to bind it the receiver. For specific bind guidelines, see section "4.2 Bind".

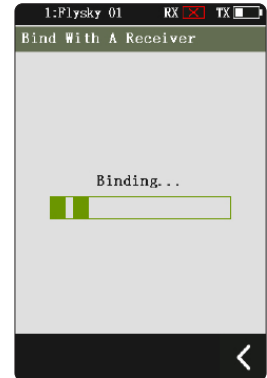

7.2 Steering Force

This function is used to adjust the amount of steering force when the receiver servo is steered.

This function can be set when the transmitter RF Setting is set to [Mini-Z(FHSS)]. It is hidden when the RF is set to other standards.

Setup:

1. Click "+" or "-" to change the percentage of steering force. The adjustment range is 0-100%, and the adjustment step is 1%. It also can be adjusted by assigning TR/VR key or knob in the [Assign] function.

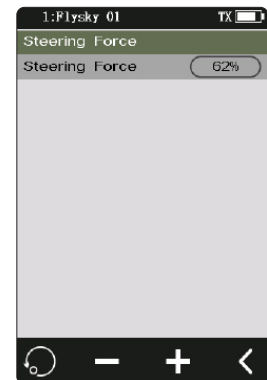

7.3 Gyro Gain

This function is used to adjust the sensitivity of the gyroscope on the receiver.

This function can be set when the transmitter RF Setting is set to [Mini-Z(FHSS)]. It is hidden when the RF is set to other standards.

Setup:

1. Click "+" or "-" to change the percentage of gyroscope sensitivity. The adjustment range is 0-100%, and the adjustment step is 1%. It also can be adjusted by assigning TR/VR key or knob in the [Assign] function.

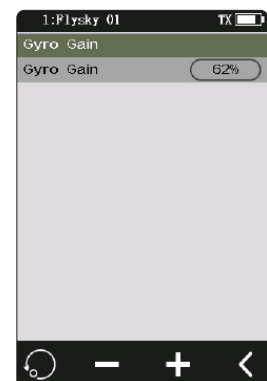

7.4 RX Interface Protocol

This function is used to set the receiver output mode.

When the adapted receiver is FGr4, FGr4S, FGr4P, FTr4, FTr10 and FTr16S, [Output] can be set to PWM or PPM. [Serial Protocol] can be set to i-BUS or S.BUS (please refer to [7.5 i-BUS Setting] for specific i-BUS setting).

Setup:

1. Click [Receiver Interface Protocol].
2. Click the right side of the corresponding function. Click  to return to the previous level interface.

The output mode of receiver NPA/NPB/NPC/NPD interface can be set when the adapted receiver is other enhanced receivers.

For the NPA/NPB/NPC/NPD interface of the primary receiver, the output modes include PWM, PPM, S.BUS, i-BUS in, i-BUS out and i-BUS2.

- When the NPA interface is set to PPM output, the other interfaces support PWM, S.BUS, i-BUS in, i-BUS out and i-BUS2 signal output.

The output modes for the secondary receiver NPA/NPB/NPC/NPD interface are PWM, PPM, S.BUS, i-BUS out and i-BUS2.

- When the RX i-BUS 2 HUB simulator function is disabled, you can select only once for PPM, S.BUS, i-BUS in, i-BUS out and i-BUS 2 signals in multiple new ports. For example, if NPA is set to i-BUS out, NPD/NPC/NPB/NPA should not be set to i-BUS out.
- The simultaneous conflict of i-BUS and i-BUS 2 transmission information is prohibited. When any new port is set to i-BUS out or i-BUS in, other new ports should not be set to i-BUS 2. If any new port is set to i-BUS 2, other new ports should not be set to i-BUS out or i-BUS in.
- When the RX i-BUS 2 HUB emulator function is enabled, multiple new ports can be set to one type of signal, such as NPA ~ PWM, NPB ~ PWM, NPC ~ i-BUS 2 HUB, and NPD ~ i-BUS 2 HUB.

[i-BUS in]: connects to i-Bus sensor.

[i-BUS out]: connects to i-Bus extension receiver or other i-Bus signal recognition device.

[i-BUS2]: When the receiver i-Bus2 HUB simulator function is disabled, only 1 i-BUS2 signal output is allowed. When the receiver i-BUS2 HUB simulator function is enabled, 1-4 i-BUS2 signal outputs can be selected.

Setup:

1. Click [Receiver Interface Protocol]. When the bind setting is in dual receiver mode, select the primary receiver or the secondary receiver to enter the submenu.
2. Select [NPA] or other options. Click the right side of the corresponding function.

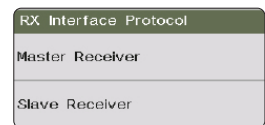
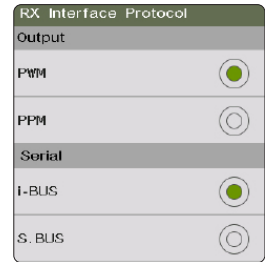

7.5 Failsafe

This function is used to protect the models and users if the receiver loses signal and therefore is no longer controllable.

A list of four channels is displayed under the failsafe menu. If [Free] is displayed next to a channel, it means that after the model loses the signal, the channel will continue to maintain the last position before the failsafe kicked in. If a percentage is displayed, it means that after the model loses the signal, channel will move to the position that position and stay there.

1. On the [Failsafe] interface, click the icon on the right of [i-BUS/PPM No Output]. After cancelation, the corresponding i-BUS/PPM signal will have no output when the model loses signal.
2. Select the desired channel to enter this channel setting interface. Click the right side of the corresponding function.
3. Move the throttle trigger, steering wheel, button, or knob of the corresponding channel to the desired setting position and keep it. Click the icon to complete the setting.

You can also use [Set All Fixed Value Channels] to set the failsafe for all channels at the same time.

This function can only be set for channels that have failsafe enabled.

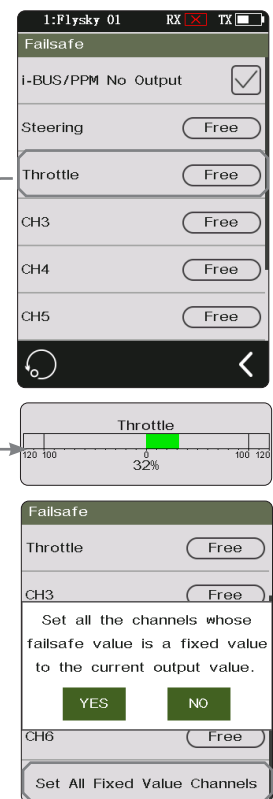

Note: Gas powered models are slightly different when it comes to failsafe setup.

Gas powered: It is recommended to set failsafe for the vehicle's brake, that is, set the throttle channel output value of the vehicle as if braking.

Battery Powered: 1. It is recommended that the failsafe is set so that it stops the vehicle, that is, set the throttle channel value of the vehicle in a neutral position.

2. It is also possible to set the failsafe to auto brake in case of signal loss.

- Some ESCs also use breaking as reverse, make sure to check this with your model.

7.6 Servos Frequency

This function is used to select the frequency of channel data PWM signals. The function includes analog servo (95 Hz), digital servo (380 Hz), and custom frequency. You can select or set the correct output frequency value according to the servo used. By default, the system adopts the digital servo. The custom frequency adjustment range is 50-400 Hz.

The servo response speed varies slightly with the connected receivers.

To connect to the classic receiver:

1. Click [Servos Frequency]. Click on the right side of the corresponding function.
 - If the transmitter RF Setting is set to [AFHDS3 one-way], modify the servo response speed and then press the exit button. The system prompts "It takes effect after bind or re-bind. Are you sure you want to bind?"
3. If you choose [Custom Frequency], click the "+" or "-" to adjust the frequency.



To connect to the enhanced receiver:

[SR]: one of the specifications in the servo response speed (PWM frequency is 833 Hz).

[SFR]: one of the specifications in the servo response speed (PWM frequency is 1000 Hz).

[Synchronization with radio frequency]: the digital signal of low frequency is synchronized with the digital signal of radio frequency.

Note: the conventional servo response speed (PWM frequency) is 50-400 Hz. The delay of the whole system will be greatly improved when SR and SFR are selected. Make sure that the adapted servo supports the corresponding frequency. Otherwise, it may cause the servo not to work properly or even damage the servo.

1. Click [Servos Frequency1] menu. Click [Direction: Digital Servo] or other options to enter the function setting interface.
2. Click the right side of the corresponding servo response speed according to the actual state of the adapted receiver. Click  to return to the previous level interface.

Click the check box on the right of [Synchronize with RF]. The icon will change to . The servo response speed of this function will be synchronized to RF after it is checked.

3. If you choose [Custom Frequency], click "+" or "-" to adjust the frequency.



7.7 i-BUS Setup

This function is used to set up the i-BUS expansion module.

The i-BUS function is mainly used for servo expansion. If a cable is too short or the number of servos exceeds the outputs for the receiver, the i-BUS module provides a convenient option for expansion. When using the i-BUS receiver, make sure that it is powered separately to ensure that servos have sufficient power.



FS-CEV04 Schematic(FGr4)



FS-CEV04 Schematic(FGr4S)

Setup:

1. Turn on the transmitter, enter [SYSTEM], touch [Channel Number Definition], and select the number of channels to be set (optional 4、6、8 channels, the system defaults to 8 channels).
2. Go to [RX SET] and bind the transmitter and receiver (see user manual for more information).
3. Touch [RX Interface Protocol] and select "i-BUS" (if "Sensor" is selected, the i-BUS port on the receiver cannot be used for channel expansion).
4. Connect the FS-CEV04 to the FGr4/FGr4S receivers "i-BUS out" port.
5. Touch "i-BUS Setup" and select the channel to be assigned, (touch "channel X", the system display a "Assigning channel X, Press the corresponding key on the serial BUS receiver to assign") Use the appropriate tool to press the K1, K2, K3 or K4 button on the FS-CEV04 to assign the selected channel to C1, C2, C3 or C4. If successful, the transmitter will display: "Channel assigned to interface X / Servo X".
6. Connect the servo to the corresponding port and check if it is working as expected.
7. Repeat the above steps as needed.

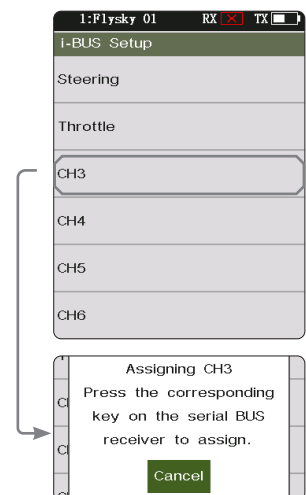



7.8 Config PWM Converter

This function allows you to configure the corresponding receiver to a PWM converter (hereinafter referred to as a secondary receiver).

Setup:

Note: Shut down the receiver.

1. Set the receiver to the bind state.
2. Turn on the transmitter. Enter the [Config PWM Converter] menu. Click the right side of [i-BUS to PWM]. This function allows you to configure the corresponding receiver to a PWM converter (hereinafter referred to as a secondary receiver).
3. Click [Start channel] to enter the submenu and select the corresponding channel as the first interface output of the receiver. Click  to return to the previous level interface.
4. Click [Servos Frequency] to enter the submenu. Click the corresponding option on the right side. You can customize the frequency of the servo. The range can be 50 Hz to 400 Hz.
 - When you select i-BUS2 to PWM, the operations of steps 2 and 3 are not required.
5. Click [Start Config]. The system will enter bind status. The secondary receiver indicator will flash twice and go off. It indicates successful configuration. Click  to manually return to the previous level interface.
6. RX re-enters the bind state to complete the bind with TX. After successful, the receiver can resume normal use.
 - Confirm that only new port A selects i-BUS2 signal.
 - When i-BUS2 receiver operates as the secondary system, the channel assignment and servo response speed are set under i-BUS2 HUB menu.
 - If you perform a re-bind, the secondary receiver parameters will be invalid. Re-configuration is required when it operates as the secondary receiver again.

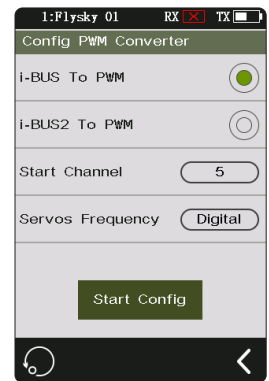

7.9 RSSI Output Setup

This function is used to set the channel of transmitter output signal strength, and transmit the signal strength to the model through the channel.

- The range of the transmitter signal strength is 0-100.
- When the signal strength is 0, the signal strength may still be calculated or the transmitter does not receive the signals from the receiver.
- After setting the channel, the channels corresponding to PWM, PPM, i-BUS out, and S.BUS indicate the signal strength. It will be invalid if the channel is assigned with other functions.

Setup:

1. Select the check box on the right side of [On] to enable this function.
2. Click [Output Channel] to select the right side of the corresponding channel.

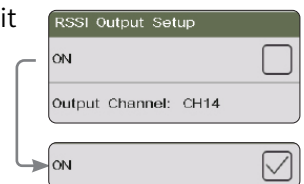

7.10 RX Battery Monitor

This function is used to detect the voltage status of the receiver battery. Set the high and low battery voltages according to the actual usage of the receiver battery and the remaining battery level displayed through the icon in the upper right corner. The transmitter will promptly send an alarm according to battery conditions.

When the receiver battery voltage is lower than the [Alarm voltage] alarm value, the transmitter will report "The receiver voltage is low".

[Sensor]: The voltage of the Voltage sensor is used as the voltage of the receiver. [Internal Voltage], [External Sensor Voltage] or [BVD Voltage] can be selected. After selection, it can be displayed and alarmed through the transmitter.

Setup:

1. Click [External Sensor] to select an internal or external sensor.
2. Set the [Low voltage], [alarm voltage], and [high voltage] values.
 - [Low Voltage]: The voltage corresponding to Receiver battery level is 0%;
 - [High Voltage]: The voltage corresponding to Receiver battery level is 100%.

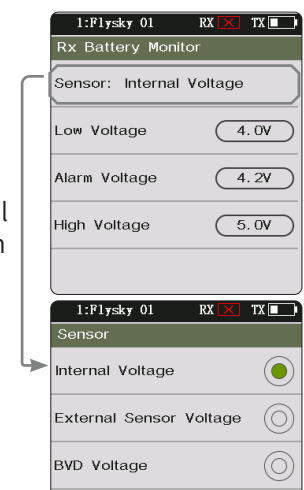

7.11 Range Test

This function is used to test whether wireless communication between the transmitter and the receiver is normal.

As the actual remote control distance between transmitter and receiver is far, it is hard to test whether the radio frequency is normal by controlling a distance of several hundred meters between the transmitter and receiver in practice. Theoretically, the remote control distance in this function will be reduced to 30-40 meters. So, you can test whether wireless communication between the transmitter and the receiver is normal at a close distance when the function is enabled. This can save testing time.

Setup:

1. Make sure the transmitter and receiver are bound.
2. Enter the [Range Test] menu and press the SW1-R button.
3. Have one person hold the transmitter and stay in place as someone else slowly walks away from the transmitter with the model.
 - Please make sure the transmitter is installed with phone holder, with use of the standard firmware.
 - Make sure that the transmitter antenna is unobstructed and that there are no objects or sources of interference between the transmitter and receiver.
4. Check the RSSI on the receiver to make sure that the signal is strong and stable.

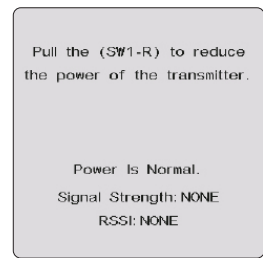

7.12 BVD Voltage Calibration

The BVD voltage is calibrated in ex-factory settings. This function can be used when there is an excessive deviation between the detected and actual voltages. The BVD voltage value can be adjusted from 0.5 V to 99.90 V.

- This function is not available for classic receivers.

[Attery Voltage] displays the battery voltage detection value of the receiver's real-time backtransage. This feature is supported only for enhanced receivers.

Note: 1. This feature is available for BVD-enabled receivers that use the AFHDS3 two-way communication protocol.

2. In dual receiver mode, this feature is only available for primary receivers.

Setup:

Connect the BVD detection line correctly before setting, and then perform calibration.

Note: please refer to the voltage value of multimeter for calibration.

1. Click [BVD voltage calibration] to enter the function setting interface.
 2. Click the "+" or "-" to change the battery voltage value as needed.
 3. Click [Calibrate]. After successful calibration, click "Yes" in the pop-up window reminder.
- This function can be set in case of an enhanced receiver. When the calibration is successful, the sensor list adds a "BVD voltage" information.

Note: When not adjusted, the [BVD voltage] value is displayed in realtime backtransl and, if set, the edited value is displayed.

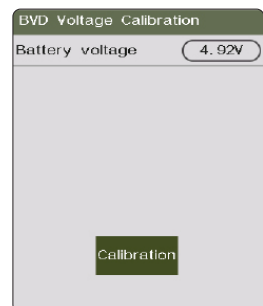

7.13 Low Signal Alarm

This function is used to enable or disable the low signal alarm function.

[Low Signal Alarm] If checked, the system will alarm automatically if the signal strength of the receiver is lower than 30.



7.14 Update Receiver

After each transmitter update the receiver will need to be updated.

Setup:

Touch [Update Receiver]:

- Some receivers such as GMR and INr4 need to be updated with "Flysky Assistant". If the transmitter has successfully coded and the connection is established, if the receiver is the latest version, a pop-up prompt will appear [The current version is the new version, no upgrade is required!]. If the transmitter is an old version, a pop-up prompt [Are you sure to update the receiver?]. Click [Yes] to update the receiver;

If the receiver and the transmitter are not connected, then enter the receiver selection interface (FGr8B/FGr4B needs to be placed upright when in use), check the receiver to be connected and pop up a prompt [Please connect XX or enable XX enter the mandatory update mode] Click [OK]!

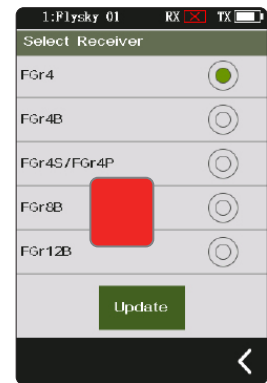

After entering the update, When the progress is 100%, the update is successful.

Note: You must update the high frequency before updating the receiver.

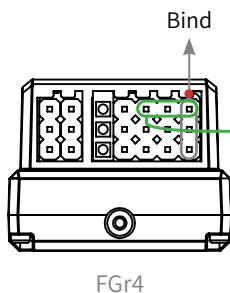
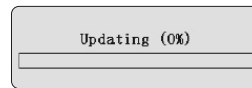

Force update interface
Connect these three pins to enter the forced update state

Force update interface
Connect these three pins to enter the forced update state

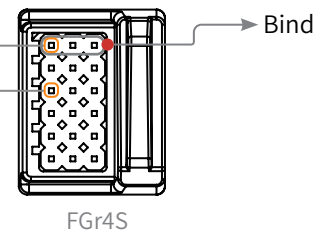

The steps of the forced update of the receiver are as follows:

1. Connect the bind cables to (as shown above) the three pin headers. After the power is turned on, the indicator flashes three times and stops for one beat;
2. Turn on the transmitter and select [Update Receiver]. Click on the right of the corresponding receiver, select "OK" in the pop-up box, and click [Update] to enter update state;
3. The indicator flashes slowly once update is completed.

- **This procedure applies to FGr4/FGr4S receiver, different receivers may enter the forced update in different ways, please go to the FLYSKY website to query the instructions of the relevant receiver for action.**

8. SYSTEM

8.1 Language

Language changes the language for the user interface.

Setup:

1. Touch "Language" to enter the menu.
2. Select a language from the list.
3. Touch the  icon to return to the previous menu.



8.2 Units

Choose what units to use for length and temperature.

Choose what units to use for length and temperature.

[Length] can select metric and imperial system. The default is metric.

[Temperature] can be selected in Celsius and Fahrenheit. The default is Celsius.

The box highlighted in light green is the currently selected setting.

Setup:

1. Touch "unit" to enter the menu.
2. Select a unit from the list.
3. Touch the  icon to return to the previous menu.

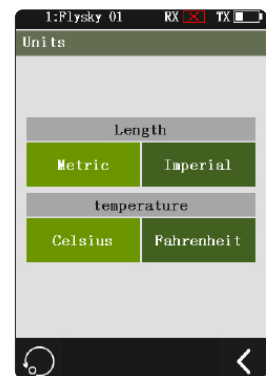

8.3 Backlight adjustment

This function controls the backlight brightness.

Note: Turning the brightness up will use more power and as such will lead to reduced battery life.

[Backlight Timeout]: Select the delay time. That is, when there is no action, the screen is reduced to a minimum brightness state after the corresponding backlight delay time, with options of 5 seconds, 10 seconds, 30 seconds, 1 minute, 2 minutes, 5 minutes, 10 minutes of backlight delay and normal light.

[Max Backlight]: The adjustment range is 10%-100%. Click the "+" or "-" icon to change the percentage as required.

[Mini Backlight]: The adjustment range is 0% -50% (the screen is not bright at 0%). The adjustment method is the same as above.

After selecting, click the back icon  to return to save.



8.4 Sound

This function is used to toggle all system sounds, including alarm sound, power-on/power-off sounds and adjust the volume.

[Volume]: Touch volume then select the desired volume from the list. Touch the back icon  to return to the previous menu.

[System sound]: Click the option box on the right side of the interface. The icon will change to , indicating that the system sound is enabled. The system will give a prompt sound in the following scenarios:

- The system will give a prompt sound when users click the transmitter function icon and sets the icon or flip the transmitter interface.
- The system will give a prompt sound each time a key is toggled.

[System Sound]: Toggle system sounds by touching the box to the right of "System sound". If there is a check in the box it is enabled.

- When the transmitter is not used for a long time exceeding the set idle alarm time, the system will give a continuous "beep" alarm.
- When the high voltage alarm or low voltage alarm in the selected sensor exceeds the set value, the system will give an alarm prompt.

[Alarm sound] and [Power On/Off sound] are the same as above.



8.5 Vibration

This function is used to enable or disable the system vibration and alarm vibration function and adjust intensity of vibration levels.

[Vibrate Level]: Touch "Vibrate Level" then select the desired strength from the list. Touch the back icon  to return to the previous menu.

[System Vibrate]: Toggle system sounds by touching the box to the right of "System Vibrate". If there is a check in the box it is enabled.

[Alarm vibration]: click the option box on the right side of the interface to enable the alarm vibration. There are alarm prompts in the following scenarios:

- The transmitter has not been used for a long time, exceeding the set idle alarm duration.
- The high voltage alarm or low voltage alarm in the selected sensor exceeds the set value.



8.6 LED

The LED function can change the color of the LED strip above the power button of the transmitter, the power indicator and the brightness adjustment of the strip.

[Type selection]

1. You can choose to turn off the LED.
2. LED can be used for power indication (displaying different colors according to current battery voltage);
 - High-green
 - Medium-yellow
 - Low-red
3. Select a color from the list.

[Brightness control]: Touch the "+" or "-" icon to adjust the LED brightness. After setting, click the icon to return to save.

Touch the back icon  to save and exit.

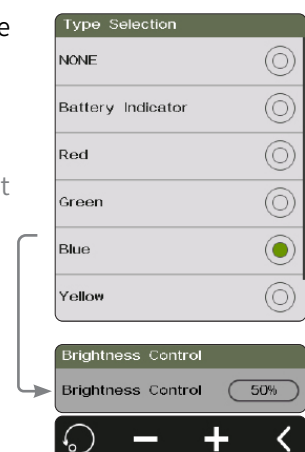

8.7 Home-Screen Quick Access

This function is used to set up the Up, Down, Left and Right quick sliding screen functions of the main interface. Users can customize the sliding screen interface according to their needs.

The [Home-Screen Quick Access] can help users find setting interfaces quickly. For example, when users want to check the lap counting time after the function is enabled in the model operations, users can use this function to enter the timer interface quickly.

Function settings:

1. Enter in the function interface, click the corresponding function option to choose it; and select NONE to avoid quick operation;
2. Click back icon  so you can save the settings.



8.8 Main Screen Lock Setup

This function is used to set the state of the transmitter after the main interface is locked.

[Touch Screen]: can prevent the transmitter screen from being touched by mistake, because this may change the parameters that have been set.

[Touch Screen + Set]: only the channel is controllable after selection. This can avoid changing the set parameters when someone else perform operations or accidentally toggles a switch for personal reasons.

[Touch Screen+Set+CH]: after locking, all knob, key, or trims are unavailable. This can prevent others from modifying channel data when operating on behalf of others or changing setting parameters by accidentally toggling a switch for personal reasons.

You can click the  icon on the right of the corresponding function according to your needs.

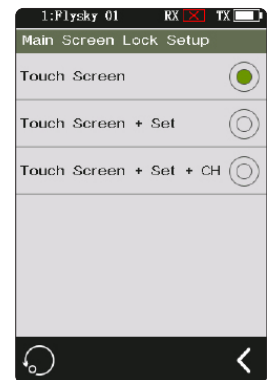

8.9 Standby Timeout

This function is used to set idle alarm intervals or no idle alarm. 5 options: [None], [3 min], [5 min], [10 min] and [20 min]. [None] means no idle alarm. The time to alert can be selected as desired. The default is 3 minutes.

Click [Standby Timeout] to enter settings, select alarm time as required, and click on the right of the option. For example, if you set the alarm time to 3 minutes, the system will give a vibration and audio alarm when the transmitter is idle for 3 minutes. You can set the on/off and volume of the sound, and the on/off and level of the vibration in [8.4 Sound] and [8.5 Vibration] in [System Settings].

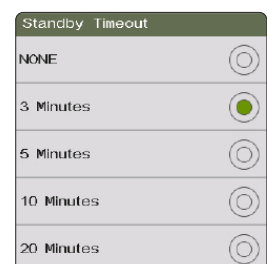

8.10 Auto Power Off

If the transmitter is powered on for a long time, the transmitter battery may be used up. If the system detects that the transmitter is not used for a long time, it will be automatically shut down.

If no operation is detected within five minutes, the system starts playing no operation sound, Auto Power Off will turn off the transmitter if no receiver is connected.

To toggle Auto Power Off touch the box to the right of the setting. If there is a check in the box the function is active.



8.11 Stick Calibration

Stick Calibration calibrates the trigger and wheel so that their center and outer positions are correct. The green bar is the channels current position and the calibrated range will be grey like the background.

Calibration:

1. Move the wheel and trigger as far as they can go in each direction.
2. Touch the  icon to save and return to the previous menu.

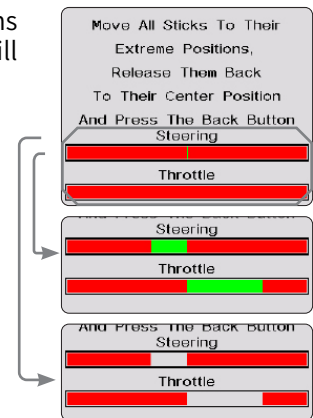

8.12 Firmware Update

The internal software of the transmitter can be updated using the USB interface connected via a windows computer. Once this function is activated, all functions of the transmitter stop. To avoid any loss of control of the vehicle, turn its receiver off before entering this mode.

When the firmware is updating, never disconnect the USB cable or remove the battery or the transmitter.

Setup:

1. Download and open the newest official software.
2. Connect a transmitter with a computer by USB cable.
3. Touch [Firmware Update], after which "Updating the transmitter firmware may cause model data to be restored to factory default values. Are you sure?" will be displayed. Touch "Yes", to enter update mode.
4. After completing the above steps, click [Update] in the software on your computer to start the update.

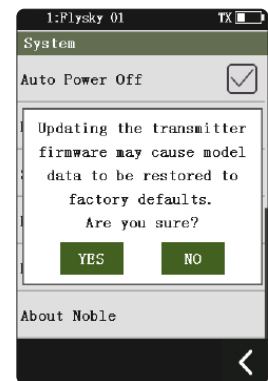

Note: The model data will be reset after the firmware update.

8.13 Factory Reset

Factory Reset resets all of the transmitter settings and functions back to their factory default state.

Reset:

Touch "Factory Reset", then touch "YES" when prompted.

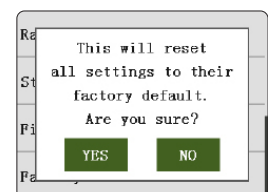

8.14 About Noble

Contains basic information including product name, firmware version, activation date and hardware version.

9. Transmitter Specification

This chapter includes specifications for NB4 transmitters, FGr4 receivers, and FGr4S receivers.

9.1 Transmitter Specification (NB4)

Product model	NB4
Product name	Nobel
Channels	4、6、8 (optional firmware options)
Model	car, boat
RF	2.4GHz
RF Power	< 20 dBm (e.i.r.p.) (EU)
2.4GHz Protocol	AFHDS 3
Distance	>300m (ground)
Channel Resolution	4096
Battery	1S (4.2V) * 4300mAh lithium polymer battery + 2600mAh 18650 dual battery
Charging Interface	Micro USB
Charging Time	base <3h / handle battery <3.5h
Life time	10h + (with base) /4.5h+ (without base)
Low Voltage Warning	< 3.65V
Antenna Type	Built-in single antenna
Display	HVGA 3.5 inch TFT, 320 * 480
Language	Chinese, English and Japanese
Simulator	USB Simulator
Data Interface	Micro USB
Temperature Range	-10°C—+60°C
Humidity Range	20%-95%
Online Update	Yes
Color	Black
Size	129*114*190 mm
Weight	520g
Certification	CE, FCC ID: N4ZFG400, MIC,RCM

9.2 Receiver Specification (FGr4)

Product model	FGr4
PWM	4
RF	2.4GHz
2.4GHz Protocol	AFHDS 3
Distance	>300m (ground)
Antenna Type	single antenna (150mm)
Power	3.5-12V
RSSI	Yes
Data port	PWM/PPM/i.bus/s.bus
Temperature range	-10°C—+60°C
Humidity Range	20%-95%
Online Update	Yes
Size	29*22*16.2mm
Weight	8g
Certification	CE, FCC ID: N4ZFGR400

9.3 Receiver Specification (FGr4S)

Product model	FGr4S
PWM	4
RF	2.4GHz
2.4GHz Protocol	AFHDS 3
Distance	>200m(ground)
Antenna Type	Built-in single antenna
Power	3.5-8.4V
RSSI	Yes
Data port	PWM/PPM/i.bus/s.bus
Temperature range	-10°C—+60°C
Humidity Range	20%-95%
Online Update	Yes
Size	25.5*22*17.3 mm
Weight	5.1g
Certification	CE, MIC,RCM, FCC ID: N4ZFGRS400

10. Package Contents

NB4*1

FGr4*1

FGr4S*1

Quick start guide *1

USB *1

Grip (L) *1

Spring (N=14T Soft)*1

Spring (N=13T Hard)*1

11. Certification

11.1 DoC Declaration

Hereby, [Flysky Technology co., ltd] declares that the Radio Equipment [Noble(NB4),FG4] is in compliance with RED 2014/53/EU.

The full text of the EU DoC is available at the following internet address: www.flysky-cn.com

11.2 CE Warning

The antenna(s) used for this transmitter must be installed to provide a separation distance of at least 20 cm from all persons and must not be co-located or operating in conjunction with any other transmitter. End-users and installers must be provided with antenna installation instructions and transmitter operating conditions for satisfying RF exposure compliance

11.3 Environmentally friendly disposal

Old electrical appliances must not be disposed of together with the residual waste, but have to be disposed of separately. The disposal at the communal collecting point via private persons is for free. The owner of old appliances is responsible to bring the appliances to these collecting points or to similar collection points. With this little personal effort, you contribute to recycle valuable raw materials and the treatment of toxic substances.



CAUTION

RISK OF EXPLOSION IF BATTERY IS REPLACED BY AN INCORRECT TYPE.
DISPOSE OF USED BATTERIES ACCORDING TO THE INSTRUCTIONS

11.4 Appendix 1 FCC Statement

This equipment has been tested and found to comply with the limits for a Class B digital device pursuant to part 15 of the FCC rules. These limits are designed to provide reasonable protection against harmful interference in a residential installation. This equipment generates, uses and can radiate radio frequency energy and, if not installed and used in accordance with the instructions, may cause harmful interference to radio communications. However, there is no guarantee that interference will not occur in a particular installation. If this equipment does cause harmful interference to radio or television reception, which can be determined by turning the equipment off and on, the user is encouraged to try to correct the interference by one or more of the following measures:

Reorient or relocate the receiving antenna.

Increase the separation between the equipment and receiver.

Connect the equipment into an outlet on a circuit different from that to which the receiver is connected.

Consult the dealer or an experienced radio/TV technician for help.

To assure continued compliance, any changes or modifications not expressly approved by the party responsible for compliance could void the user's authority to operate this equipment.

This equipment complies with Part 15 of the FCC Rules. Operation is subject to the following two conditions:

- (1) This device may not cause harmful interference, and
- (2) This device must accept any interference received, including interference that may cause undesired operation.

Caution!

The manufacturer is not responsible for any radio or TV interference caused by unauthorized modifications to this equipment. Such modifications could void the user authority to operate the equipment.

1. Move all your channels to the desired position.
2. Select [All channels] and then [Yes] in the confirmation box.



www.flysky-cn.com

Copyright ©2022 Flysky Technology co., ltd

Release date: 2022-02-10



FCC ID: N4ZFG400

Manufacturer: ShenZhen FLYSKY Technology Co., Ltd
Address: 16F, Huafeng Building, 6006 Shennan Road, Futian District, Shenzhen, Guangdong province, China