

Paladin PL18

User Manual

2.4GHz
AFHDS 3

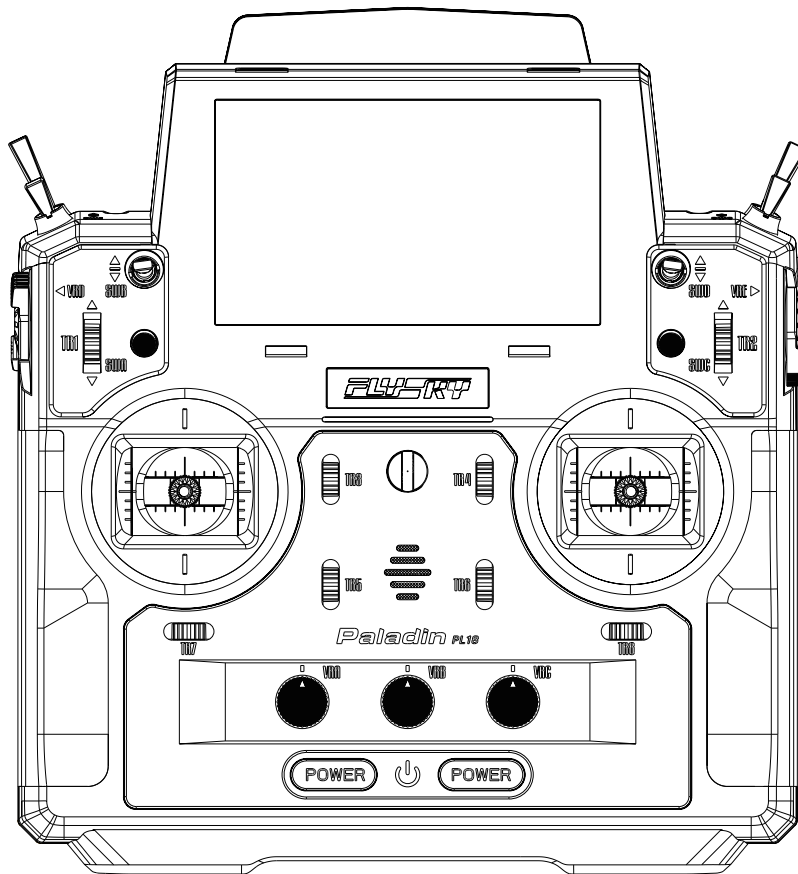

FLYSKY

Touching Infinity

Copyright ©2022 Flysky Technology co., Ltd.



WARNING:
This product is only for 15 years
old or above.



微信公众号



Bilibili



Website



Facebook



Thank you for purchasing our products.

Read the manual carefully to ensure your personal safety as well as the safety of your equipment.

If you encounter any problems during using, please refer to this manual first. If the problem is still not resolved, please contact the local dealer directly or contact the customer service staff via the website below:

<http://www.flysky-cn.com>

Table of Contents

1. Safety	1	7.7.1 Assigning Function Items	24
1.1 Safety Icons	1	7.7.2 Control Assign	24
1.2 Safety Guide	1	7.7.3 Function Trim Assignment	26
2. Battery Safety Instructions	2	7.8 Trim	27
3. Product Description	3	7.8.1 Setting TR1 Trim	27
3.1 System Features	3	7.8.2 Setting VRA Trim	28
3.2 Transmitter Overview	4	7.9 Sensors	29
3.2.1 Transmitter Antenna	7	7.9.1 Displaying Sensors	29
3.2.2 Stick/Knob/Switch/Button	7	7.9.2 Sensor Setup	30
3.2.3 Status LED	7	7.10 Timers	34
3.2.4 Stick mode	8	7.10.1 Timer 1/2	34
3.2.5 Gimbal Assembly Adjustment	8	7.10.2 Engine Timer	34
3.2.6 Power Switches	9	7.10.3 Model Timer	34
3.2.7 Charging Mode	9	7.11 RF Setting	35
4. Pre-operation Setup	10	7.11.1 Transmit	35
4.1 Receiver And Servo Installation	10	7.11.2 RF Set To Be On By Default	35
5. Operation Guidelines	11	7.11.3 RF Type	35
5.1 Power On	11	7.11.4 FRM303 RF Module	36
5.2 Binding	11	7.11.5 PPM Setting	36
5.3 Pre-operation Checks	12	7.11.6 RF firmware Updating	37
5.4 Power Off	12	7.11.7 RF Version	37
6. Main Interface	13	7.12 RX Setting	38
6.1 Main Interface Overview	13	7.12.1 Bind Setting	38
6.1.1 Status Bar (Top)	14	7.12.2 Custom Port Protocol	38
6.1.2 Quick Access	14	7.12.3 Failsafe	39
6.2 Interface	15	7.12.4 PWM Frequency	41
6.2.1 Function Icons	15	7.12.5 Low Signal Voice Alarm	42
7. Basic Settings	16	7.12.6 Low Voltage Voice Alarm	42
7.1 Display Servos	17	7.12.7 BVD voltage calibration	43
7.1.1 Display Servos	17	7.12.8 Config RX As A PWM Converter	43
7.1.2 Channel Test	17	7.12.9 i-BUS2 Device Display	44
7.2 Model Select	18	7.12.10 i-BUS2 RPM Sensor	44
7.2.1 Automatical Searching For The Receiver	18	7.12.11 Set i-BUS2 HUB As A PWM Converter	45
7.2.2 Copying A Model	19	7.12.12 i-BUS2 PWM Converter Setting	45
7.2.3 Create A New Model	19	7.12.13 i-BUS2 GPS Sensor Setting	46
7.2.4 Selecting A Model	19	7.12.14 i-BUS Setting	48
7.2.5 Deleting A Model	20	7.12.15 Signal Strength Output Setting	48
7.3 Model Setup	20	7.12.16 Midpoint Offset	49
Model Type Setup	20	7.12.17 Receiver Update	49
7.4 Reverse	22	7.12.18 About Receiver	49
7.5 Channel Route	23	7.13 Trainer Mode	50
7.6 Subtrim	23	7.13.1 Student Mode	50
7.7 Function Assignment	24	7.13.2 Trainer Mode	51

8. Airplane/Glider Exclusive Function Setting.....54

8.1 Display Servos.....	55
8.2 Condition.....	55
8.2.1 Rename	55
8.2.2 Set Switch	56
8.2.3 Creating/Copying A Condition.....	56
8.2.4 Deleting A Condition	56
8.2.5 Changing The Order Of The Conditions.....	56
8.3 Func. Rate(AFR).....	57
8.3.1 Setting Curve Type.....	57
8.3.2 Setting Rate/EXP/Offset	57
8.4 DR Setting.....	58
8.5 Channel Offset.....	58
8.6 Program Mixes.....	59
8.6.1 Setting Master And Slave	59
8.6.2 Setting Mix Delay.....	61
8.6.3 Setting Mix Rate.....	61
8.7 Servo Speed	61
8.7.1 Servo Speed- Set By Function	62
8.7.2 Servo Speed- Set By Channel	62
8.7.3 Servo Speed- Set By Condition	63
8.8 Throttle Curve	63
8.9 Throttle Cut	64
8.10 Idle Up	64
8.11 Throttle Needle.....	65
8.12 Aileron	65
8.12.1 Aileron Differential.....	66
8.12.2 Aileron Elevator.....	66
8.12.3 Aileron Camber Flap	66
8.12.4 Aileron Brake Flap.....	67
8.12.5 Aileron To Elevator	67
8.12.6 Aileron To Rudder.....	67
8.13 Flap	68
8.13.1 Flap Setting.....	68
8.13.2 Brake To Airfoil	69
8.13.3 Airfoil To Elevator.....	69
8.13.4 Brake Flap To Elevator	70
8.14 Airbrake	70
8.14.1 Brake Speed	71
8.14.2 Brake Rate.....	71
8.15 Spoiler	71
8.16 Elevator.....	72
8.16.1 Elev. Linkage.....	72

8.16.2 Elev. Aileron	73
8.16.3 Elev. To Airfoil Flap	73
8.16.4 Elev. To Brake Flap.....	74
8.17 Rudder	74
8.17.1 Rudd. Linkage.....	74
8.17.2 Rudd. To Aileron.....	75
8.17.3 Rudd. To Elevator.....	75
8.18 Butterfly.....	76
8.19 V Tail.....	76
8.20 Logic Switches	77
8.21 Attitude.....	78
8.22 Telemetry Control.....	79

9. Helicopter Exclusive Function Setting...81

9.1 Display Servos.....	81
9.2 Condition.....	81
9.3 Func. Rate (AFR)	81
9.4 DR Setup.....	81
9.5 Channel Offset.....	81
9.6 Pro. Mixes	81
9.7 Servo Speed	81
9.8 Throttle Curve	82
9.9 Pitch Curve	82
9.10 Throttle Cut	82
9.11 Idle Up	82
9.12 Throttle Hold	82
9.13 Throttle Needle.....	83
9.14 Swashplate	83
9.15 Thro Mixed	83
9.16 Swashplate Ring	83
9.17 Hover Adjust	84
9.18 Gyroscope	85
9.19 Governor	85
9.20 Logic Switches	85
9.21 Telemetry Control.....	85

10. Multicopter Exclusive Function Setting.....86



10.1 Display Servos.....	86
10.2 Condition.....	86
10.3 Func. Rate (AFR)	86
10.4 DR Setup.....	86
10.5 Channel Offset	86
10.6 Pro. Mixes	86
10.7 Servo Speed	86
10.8 Throttle Curve	87

10.9 Throttle Hold	87	14.1.1 Language Setting	96
10.10 Attitude	87	14.1.2 Units	96
11. Car Exclusive Function Setting	88	14.1.3 Sound	97
11.1 Display Servos	88	14.1.4 Vibration	97
11.2 Condition	88	14.1.5 Auto Search For Receiver	97
11.3 Func. Rate (AFR)	88	14.1.6 Factory Reset	98
11.4 DR Setup	88	14.1.7 Updating Transmitter Firmware	98
11.5 Channel Offset	88	14.1.8 About Paladin PL18	98
11.6 Pro. Mixes	88	14.2 Display Setting	99
11.7 Servo Speed	88	14.2.1 Backlight Timeout	99
11.8 Throttle Curve	89	14.2.2 Backlight Brightness	99
11.9 ABS	89	14.2.3 Standby Timeout	99
11.10 Track Mixing	91	14.2.4 Autoshtut Down	100
11.11 Logic Switches	91	14.3 Qucik Access Setting	100
11.12 Telemetry Control	91	14.4 Position-switch Setup	101
12. Boat Exclusive Function Setting	92	14.5 Stick Calibration	101
12.1 Display servos	92	14.6 Range Test	101
12.2 Condition	92	14.7 Hlep Center	102
12.3 Func. Rate (AFR)	92	15. Custom Menu Setting	103
12.4 DR Setup	92	16. Same Common Operation Items Setting	104
12.5 Channel Offset	92	16.1 Switch assignment	104
12.6 Pro. Mixes	92	16.1.1 Normal ON/OFF Switch Setting	104
12.7 Servo Speed	92	16.1.2 Position-switch Setting	104
12.8 Throttle Curve	92	16.1.3 Continuous Switch Setting	105
12.9 Logic Switches	93	16.1.4 Logic Switch Setting	106
12.10 Dual Engine Mix	93	16.2 Linear Setting	106
12.11 Rudd Linkage	93	17. How Transmitter Output Functions Are Processed	107
12.12 Telemetry Control	93	18. Product Specification	108
12.13 Throttle Hold	93	19. Package Contents	109
12.14 Throttle Needle	93	20. Certifications	110
12.15 Throttle Curve	93	20.1 DoC	110
13. Robot Exclusive Function Setting	94	20.2 CE Warning	110
13.1 Display Servos	94	20.3 FCC Statement	110
13.2 Condition	94	20.4 Environmentally Friendly Disposal	111
13.3 Func. Rate (AFR)	94		
13.4 DR Setup	94		
13.5 Channel Offset	94		
13.6 Pro. Mixes	94		
13.7 Servo Speed	94		
13.8 Telemetry Control	94		
13.9 Track Mixing	95		
13.10 Logic Switches	95		
14. System Setting	96		
14.1 General Function Setting	96		

1. Safety

1.1 Safety Icons

Pay attention to the following icons and their meanings. Failure to follow these guidelines can result in equipment damage or personal injury.

 WARNING	• Not following these instructions may lead to minor injuries.
 CAUTION	• Not following these instructions may lead to major injuries.
 DANGER	• Not following these instructions may lead to serious injuries or death.

1.2 Safety Guide



Prohibited



Mandatory



- Do not fly at night or in bad weather like rain or thunderstorm. It can cause erratic operation or loss of control.
- Do not use the product when the visibility is limited.
- Do not use the product on rainy or snowy days. Should any type of moisture (water or snow) enter any component of the system, erratic operation and loss of control may occur.
- Interference could cause loss of control. To ensure the safety of you and others, do not operate in the following places:
 - Near any site where other radio control activity may occur.
 - Near high voltage power lines or communication broadcasting antennas.
 - Near water with passenger boats nearby.
 - Near high voltage wires or communication/broadcast antennas.
- Do not use this product if you are tired, uncomfortable or when using substances that may impair your ability to use the product safely.
- The 2.4GHz frequency band requires line of sight from the transmitter to receiver at all times. Avoid large obstacles that could block or interfere with the signal.
- In order to ensure good signal quality, do not hold the transmitters antenna during use.
- Parts of the model, such as motors or ESC's may remain hot for a period of time after use and can cause severe burns.



- Improper use of this product may lead to serious injury or death to the user and others. To ensure the safety of yourself and others read and follow the instructions set out in the user manual.
- To avoid damage to the model, make sure that the product and model are installed correctly before use.
- Always power off the receiver before the transmitter. Powering off the receiver before the transmitter could lead to loss of control.
- Before use make sure that all the servos and motors are moving in the correct direction.
- Make sure to remain within range to prevent loss of control.



微信公众号



Bilibili



Website





Facebook

2. Battery Safety Instructions

Danger

 This products battery is rechargeable and non-removable. Do not remove the battery from the product.

 Do not expose the battery to liquids.
■ Do not use a damp battery. Keep your hands dry during use and do not leave batteries in areas with lots of moisture.

 Do not solder, repair, modify or disassemble the battery.

 Do not charge the battery in direct sunlight, in a hot car or near anything hot such as cookers etc.

 Do not use near flammable liquids or gasses.

WARNING

 Do not Tap the charger or battery during charging.

■ May cause burns

 Keep the battery away from any heat source if it is leaking or causing strange smells.

■ May catch fire or explode.

 Do not store the battery in dusty or humid environments.

■ Remove dust from the power connector before plugging in.

 Do not charge batteries that show any evidence of damage, aging, leakage or exposure to liquids.

 Do not Tap the positive and negative terminals of the battery together.

 Do not throw the battery into a fire.

 Do not charge without ventilation.

 Charge Transmitter Battery before use.

■ If there is not enough quantity of electricity during the flight, it will lead to a airplane crash.

 Do not throw or impact the battery.

■ May cause fire or an explosion.

 Put some tape on the battery's terminals before recycling.

■ If the short circuit causes fire, heat, rupture, etc.

 Do not charger the battery when exposed to extreme heat or cold.

■ May lead to a drop in battery performance. To ensure maximum performance always charge the battery within the temperature range of 10°C ~30°C .



3. Product Description

PL18 is an 18-channel air transmitter with 2.4GHz AFHDS 3 (third-generation automatic frequency hopping digital system). And there is a variety of built-in models that you can set as your desired. It adapts fixed-wing aircraft, helicopters, gliders, multicopters, robots, boats or cars.

3.1 System Features

AFHDS 3 (third-generation automatic frequency hopping digital system) is a newly developed digital wireless system with independent intellectual property rights by FLYSKY. It is compatible with one-way and two-way real-time data packet transmission and transparent data stream transmission. In other words, this system has advantages of both AFHDS 2A and WS2A wireless system. It equips with a brand-new 2.4G chip, stable and reliable connection, good real-time performance, and supports various configurations. Bring you the optimal configuration for multi-scenario application performance.

Compatible with Unidirectional/Bidirectional Real-time Data Transmission	The system supports one-way and two-way connections. When the transmitter is working in one-way transmission way, the receiver can receive data from the transmitter. When the transmitter is working in two-way transmission way. The receiver can receive data from the transmitter and the transmitter can also receive data from the receiver, as well as the information cross from the temperature and speed sensor modules.
Data Transparent Transmission	The independent data transparent transmission module is built into RF system, which can realize data transmission via transmitter and transparent transmission. It can be used for data transmission of flight control.
Intelligent RF configuration	To set the parameters which affect RF transmission distance, speed and anti-interference, such as numbers of channels, resolution, bandwidth and receiver sensitivity. The system can be set according to different application requirements to obtain the most suitable performance.
Multi-channel Frequency Hopping	This systems bandwidth ranges from 2.402GHz to 2.480GHz. Set intelligent RF configurations according to your required, it can avoid or reduce the interference from other transmitters with the same frequency via different configurations, different time of powering on the transmitter, various patterns to the hopping frequency and various using frequency spots.
Unique ID Recognition System	Each transmitter and receiver has it's own unique ID. Once the transmitter and receiver have been bound, they will save the each other's ID and only connect with each other. When the syetem is working,if the IDs are matched with each other, then the connection will be connect, otherwise, there is no connection between transmitter and receiver. This unique ID recognition syetem resists the interference so as to make the system stabler and more reliable.
Low Power Consumption	It is built using highly sensitive, low power consumption components. And it works in the way of interval data transmission to improve transmitting efficient effectively and extend the working time of the battery distinctly, while it consumes as little as one tenth the power of a standard FM system.



微信公众号



Bilibili



Website



Facebook

3.2 Transmitter Overview

Front View

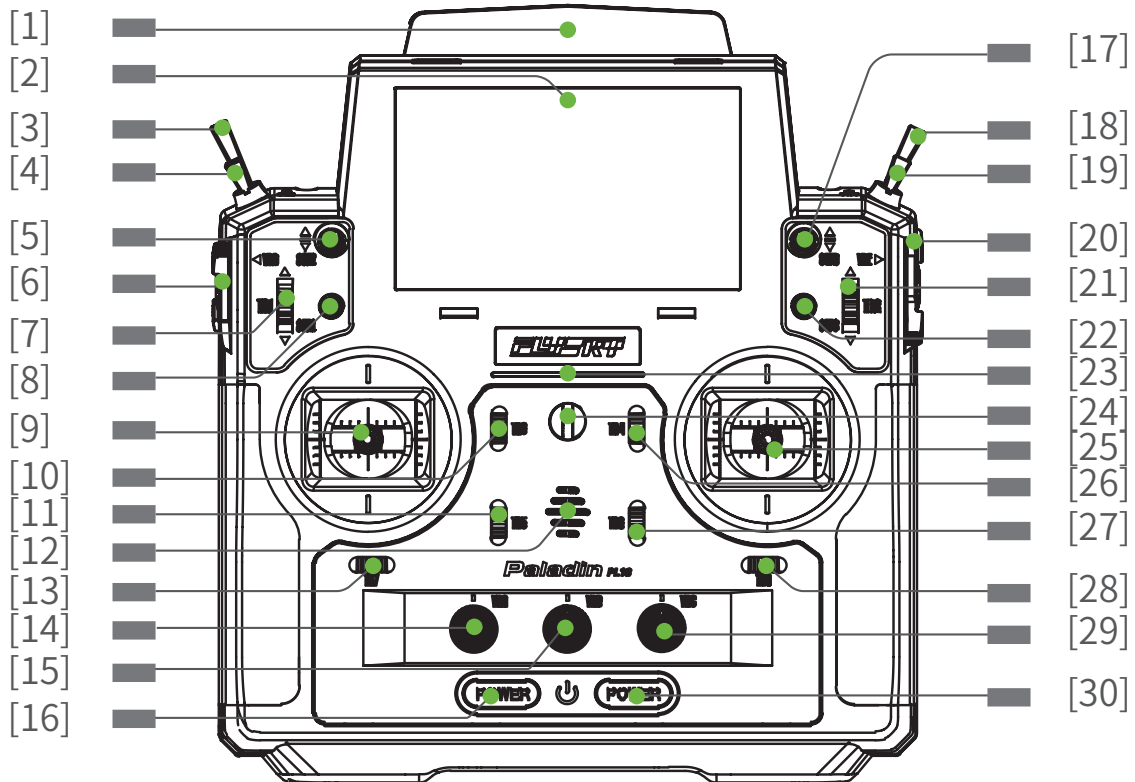

[1]	Antenna	[11]	TR5 Trim	[21]	TR2 Trim
[2]	LED Screen	[12]	Speaker	[22]	SWC Button
[3]	SWF Position Switch	[13]	TR7 Trim	[23]	Transmitter Status Indicator
[4]	SWE Position Switch	[14]	VRA Knob	[24]	Neck Strap Hook
[5]	SWB Position Switch	[15]	VRB Knob	[25]	Right Stick
[6]	VRD Knob	[16]	Power Switch	[26]	TR4 Trim
[7]	TR1 Trim	[17]	SWD Position Switch	[27]	TR6 Trim
[8]	SWA Button	[18]	SWH Position Switch	[28]	TR8 Trim
[9]	Left Stick	[19]	SWG Position Switch	[29]	VRC Knob
[10]	TR3 Trim	[20]	VRE Knob	[30]	Power Switch



Front View- Reset Button

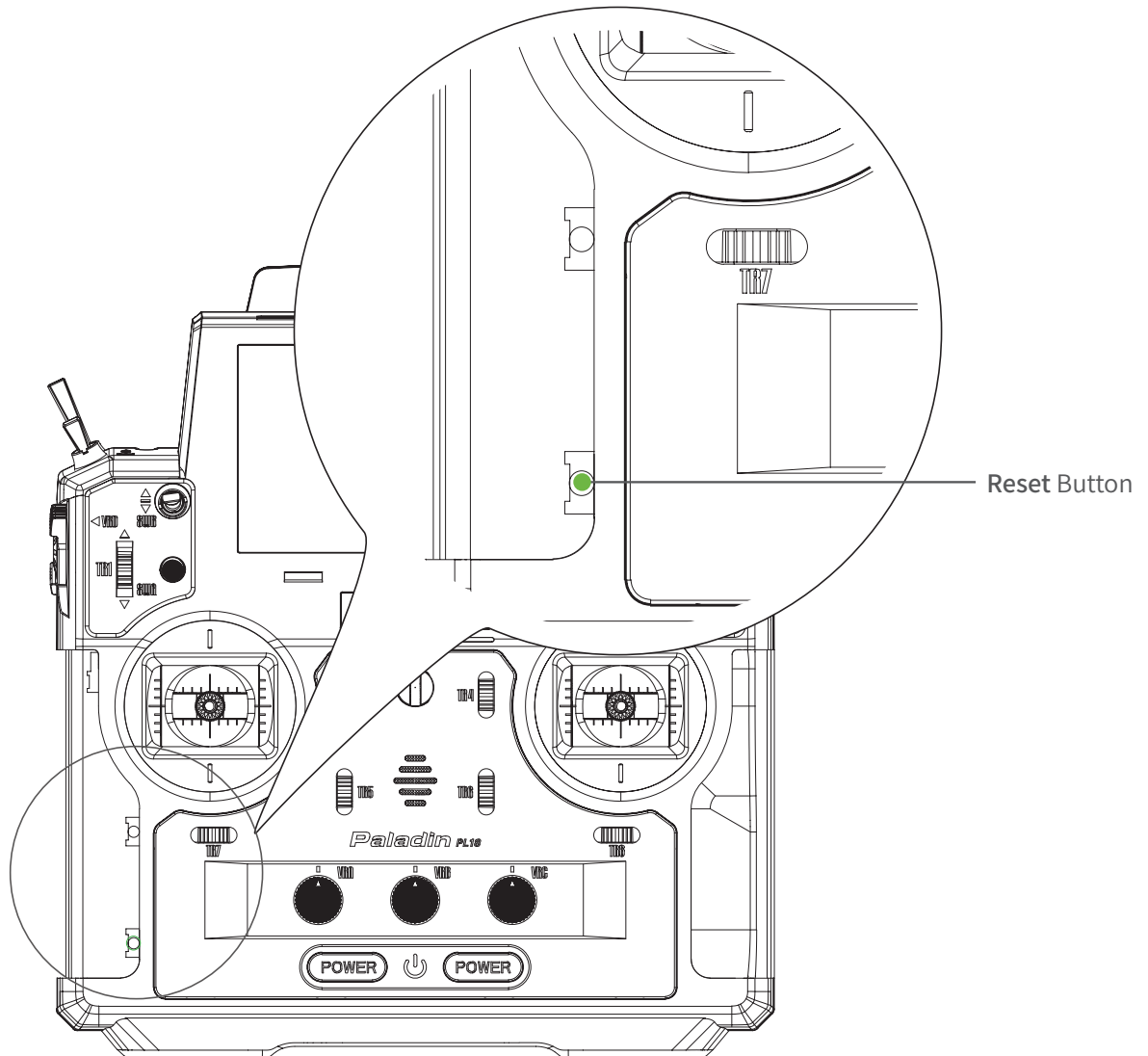

The reset button is accessible at the lower part of the transmitter as shown above. You need to tear apart the grip to find it. To press it by using a long thin tool, such as a smaller screwdriver.

In case of the transmitter can not be powered off by pressing the two **Power Switches**, please reset the transmitter with the **Reset** button.



CAUTION

• After resetting, the settings which set before resetting may be invalid.



微信公众号



Bilibili



Website



Facebook

Back View

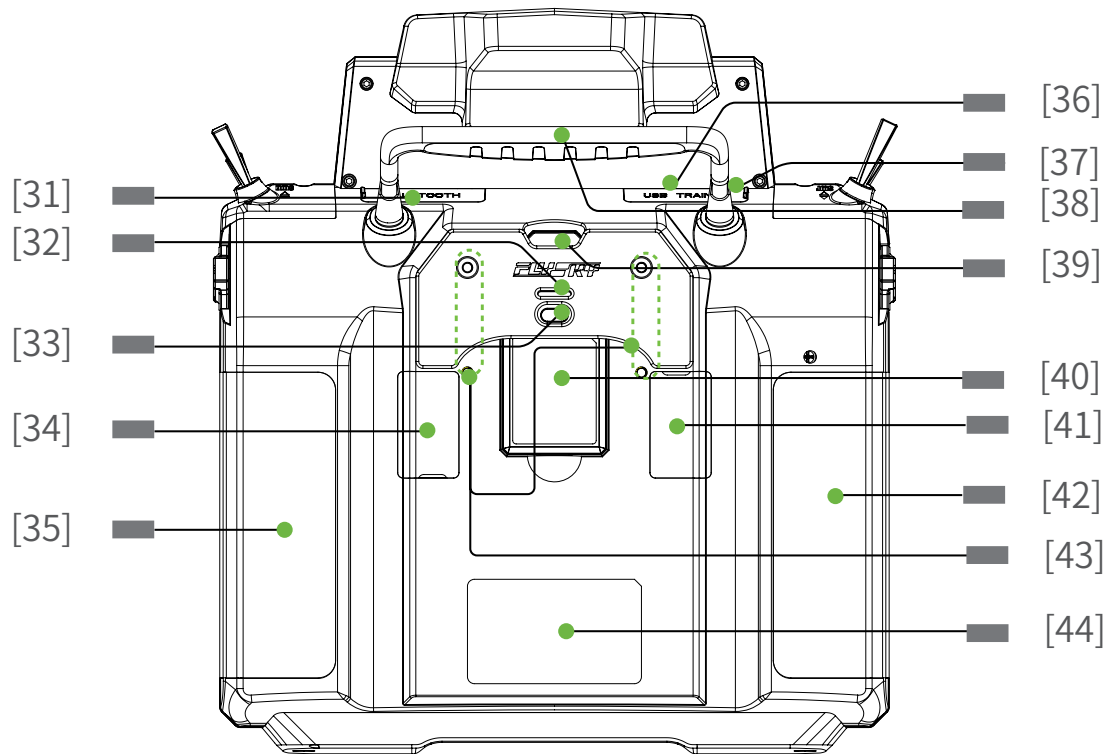

- | | | | |
|------|----------------------------|------|--|
| [31] | Bluetooth Module interface | [38] | Carrying Handle |
| [32] | FRM301 Status Indicator | [39] | Press to release FRM301 |
| [33] | FRM301 Button | [40] | FRM301 RF Module |
| [34] | Gimble Tension Adjustment | [41] | Gimbal Tension Adjustment |
| [35] | Grip | [42] | Grip |
| [36] | Micro USB interface | [43] | Screw holes for fixing RF Module adapter |
| [37] | Trainer Jack | [44] | Wireless Charging Area |



3.2.1 Transmitter Antenna

PL18 transmitter has two built-in antennas. When the transmitter starts to work, the antennas automatically operate, without additional operations.

	CAUTION • To ensure a good signal do not cover or block the antenna.
---	--

3.2.2 Stick/Knob/Switch/Button

The PL18 has 2 sticks (Left stick and right stick), 6 switches (SWB, SWD, SWE, SWF, SWG and SWH) , 5 knobs (VRA to VRE) and 2 buttons (SWA and SWC), and 8 trim buttons (TR1 toTR8).

Sticks: Output different value when it is in different position, they can output continuous signal. And they can be used as function controls, as well as switches to turn on/off the function.

Knobs: The knobs can implement the same function as sticks. Part of them can be used as trim controls.

Switches: There are two-position switches and three-position switches. Different value is corresponding to different position. They can be used as function controls, as well as switches to turn on/off the function.

Buttons: The buttons can implement the same function as switches.

Trim buttons: Output different value when toggling up/down. They can be used as function controls, refer to **7.8 Trim** for detailed.

3.2.3 Status LED Note: This function is available for 1.0.65 or later.

The status LED is used to indicate the power supply state of the transmitter and its working state. The LED lights up in three states: gradual light, flashing, and solid on.

- The LED is off, indicating that the transmitter is powered off.
- When the screen is off , and the LED is in gradual light state:
 1. The LED colour changes alternatively among cyan, magenta, and yellow. It indicates that the RF is enabled and the receiver is not connected or bound in one-way.
 2. The LED colour is yellow, indicating that the RF is disabled and the receiver is not connected.
 3. The LED colour changes alternatively among red, green and blue. It indicates that the RF is enabled and the receiver is connected.
- When the screen is on, and the LED is solid on:
 1. The LED colour is blue, indicating that the RF is enabled and the receiver is not connected or bound in one-way.
 2. The LED colour is yellow, indicating that the RF is disabled and the receiver is not connected.
 3. The LED colour is green, indicating that the RF is enabled and the receiver is connected successfully.
- The LED is flashing in red, indicating that there is an alarm.
- The LED is flashing fast in green, indicating that the binding is in progress.
- The LED is cyan: The transmitter is powered on until it starts successfully.

Note: When the binding and an alarm are generated at the same time, the binding takes priority. That is, the LED will be flashing fast in green.



微信公众号



Bilibili



Website



Facebook

3.2.4 Stick mode

This system supports four stick modes. As for aircraft models, from channel 1 to channel 4, by default, these four channels are assigned to aileron, elevator, throttle, and rudder. There are four preset modes of the sticks in order to meet the different requirements. You can select suitable mode among **Mode1**, **Mode2**, **Mode3** and **Mode4**. The green icon indicates the currently selected mode, and the default mode is **Mode 2**. You can select suitable mode as your desired. Then you need to adjust the gimbals as needed to match the mode. Follow the steps below.

Function Settings:

Enter the Model Setup interface via **Home1 > Basic > Model**, then tap the function box next to **Stick** to enter the stick mode. Select the mode as your desired. Then click  to return.

Note: It is also can be set in updating wizard interface after the transmitter firmware is updated. The factory preset mode for the stick can be set in this interface. Only transmitter firmware version 1.0.55 or above has this function.

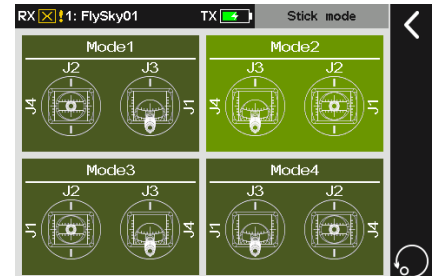

3.2.5 Gimbal Assembly Adjustment

Be used to adjust the states of self-centering and resilience strength of the 5D multiplex stick.

Function Settings:

By adjusting the screws on the back of the transmitter, gimbal stick can be either self-centering or non self-centering, as well as changing stick tension/friction.

Available options:

① . ⑤	To change the gimbal sticks self-centering or non self-centering.	② . ⑥	To change vertical tension strength of the gimbal sticks.
③ . ⑦	To change horizontal tension strength of the gimbal sticks.	④ . ⑧	To change the vertical friction strength of the gimbal sticks

CAUTION • **When the counterclockwise adjustment is made, the entire range of movement of the screw is about 6 circles(the tightest to the loosest). Be cautious not to adjust it too far or the screw will fall out.**

Take left gimbal as example:

- Non Self-return to Self-centering:**
1. Use a Phillips screwdriver to adjust the screw ① counterclockwise until the gimbal reaches its neutral position.
 2. Adjust screw ④ counterclockwise to adjust the frictional strength.
 3. If you need to adjust the strength of the centering, adjust screw ② to change the strength of return to the neutral position, and to strengthen the strength clockwise, otherwise it's to reduce.

- Self-return to Non self-centering:**
1. Use a Phillips screwdriver to adjust the screw ① clockwise so that the gimbal is no longer at its neutral position.
 2. Adjust the screw ④ clockwise to strengthen or reduce the frictional strength.
 3. If you need to adjust the strength of the centering, adjust screw ② change the strength of return to the neutral position, and to strengthen the strength clockwise, otherwise it's to reduce.

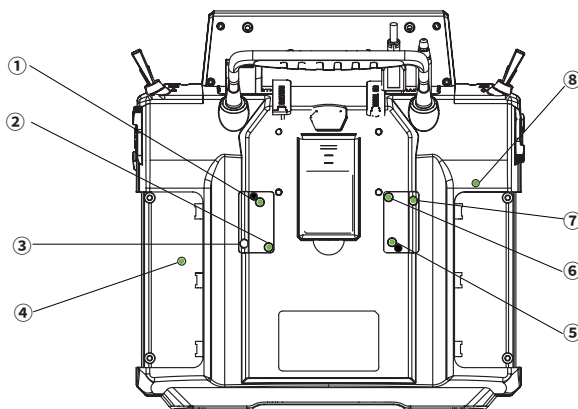

Back View of Gimbal Assembly

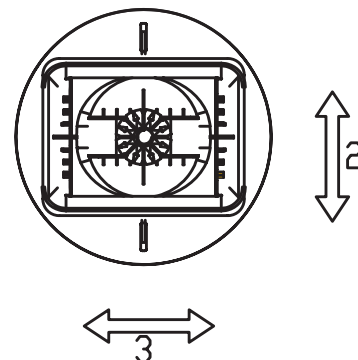

View of Stick's Swing



微信公众号



Bilibili



Website



Facebook

3.2.6 Power Switches

To prevent false triggering, there are two switches on the lower part of the transmitter. Turn on or turn off the transmitter when both switches are pressed at the same time.

3.2.7 Charging Mode

PL18 can be charged in two ways:

1. Plug the micro USB cable into the **Micro USB** interface of the transmitter for charging.
2. Use the wireless charging dock to charge it.

Notes:

1. Charge it within the safe range (4h@5V*2A//7h@5V*2A wireless charging). Overcharging may lead to battery damage.
2. To prolong the service life of the battery, properly discharge if you want to store it for a long time (that is, not fully charged). In addition, you need to charge it regularly to prevent damage due to not-operation for long term. and charge it regularly to prevent over-discharging damage during storage; It is recommended that the lithium battery be charged to 40-50% of its capacity for preservation. For example, it is recommended that the storage voltage of lithium battery is 3.85V in case of preservation. You need to check the voltage value of the battery every 3~6 months.
3. The transmitter will shut down automatically along with a voice reminder if the voltage is lower than 3.4V.
4. When the battery of the transmitter is in over discharge state and the transmitter is powered off, and at this time if the transmitter is to be charged, it will be in a slow charging mode. The battery symbol shows a yellow lightning icon when the transmitter is charging while powering on.



CAUTION

- **Please use the micro USB cable shipped with this transmitter. Improper use may cause damage to the battery and affect its service life.**



微信公众号



Bilibili



Website



Facebook

4. Pre-operation Setup

Follow the instructions and guidelines in this chapter before use.

4.1 Receiver And Servo Installation

Make sure that the receiver is mounted in an appropriate location within the model, to ensure a stable signal, maximum range and to mitigate external interference, follow these guidelines:

Pay attention to the following when installing the receiver:

1. Make sure the receiver is not installed near ESCs or other sources of electrical noise.
2. Keep the receivers antenna away from conductive materials such as carbon or metal. To ensure normal function make sure there is a gap of at least 1cm between the antenna and the conductive material.



CAUTION

• **To prevent damage do not power on the receiver during installation.**



5. Operation Guidelines

Follow these guidelines to use the transmitter and the receiver.

5.1 Power On

Note: If the power-on wizard interface appears when the transmitter is turned on for the first time after updating the firmware, follow the prompts to set [Stick Mode], [Stick Calibration] and [Update RF], and then click [Start] and the system will continue to start.

Follow the steps below to power on:

1. Check to make sure the receiver is installed correctly and that the receiver is powered off.
2. Press and hold both **Power Switches** until the screen lights up.
3. Power on the receiver.

Note: If the RF module is disabled while the transmitter is turning on, to enable it, then the receiver can be connected.

	CAUTION	<ul style="list-style-type: none"> The system is now active, be cautious to not cause damage or personal injury.
	CAUTION	<ul style="list-style-type: none"> If SWA/SWB/SWC/SWD/SWE/SWF/SWG/SWH switches are not at their high positions and the throttle stick is not at its low position when the transmitter is powered on. A prompt will appear to remind you to put these switches and throttle stick to their proper positions. It is recommended to follow the reminder to put them to their proper positions. The transmitter will launch. If you click Go to launch the transmitter without putting them to their proper positions, this may lead to danger.

5.2 Binding

Note: Adds C-Fast 10ch function item and the function of identifying compatible receivers of non-FlySky authorized third party brands for version 1.0.55 or later.

The transmitter and the receiver have been pre-bound at the factory. If you need to rebind or bind a new receiver follow the steps below. The Flysky AFHDS 3 receivers are consisted by classic version receivers and enhanced version receivers. The bind method is slightly different between these two versions.

Note: Flysky AFHDS 3 classic version receiver models: FTr10/FGr4/FGr4s/FGr4p/FTr4/FTr16S. Other Flysky AFHDS 3 receivers are enhanced version receivers.

	WARNING	<ul style="list-style-type: none"> Power off the servo while the transmitter and the receiver is binding. Otherwise, it may lead to danger. After the binding process is completed, power off the receiver, then power on the receiver and check to make sure that the transmitter and the receiver have bound successfully.
--	----------------	--

To enter the Bind setting interface via Home1 > Basic function > RX setting.

The binding interface of classic version receiver:



微信公众号



Bilibili



Website



Facebook

The binding interface of enhanced version receiver:

Note: Routine 18ch, Lora 12ch and Fast 8ch can only be bound with enhanced receivers.

Provides 18 channels with moderate communication distance.

Provides 12 channels with super anti-interference and moderate communication distance.

Provides 8 channels, fast communication within short distance.

To set the starting channel of the primary receiver.

To bind the transmitter with the primary receiver. Click it to put the transmitter into bind mode.

To set double receivers or not. If there is a tick, indicating that the double receivers are set.

To set the starting channel of the secondary receiver.

To increase/decrease a value. Increases a value by tapping + and decreases a value by tapping -.

To bind the transmitter with the secondary receiver. Click it to put the transmitter into bind mode.

Function Settings:

1. Power on the transmitter, enter the bind setting interface via **Home 1> Basic > RX setting**.
2. Tap **Bind setting** and enter the binding setting interface. Then set some items, such as selecting suitable RF System, choosing two way or not, or setting the starting channel. Afterwards, click **Bind** to put the transmitter into bind mode.
3. Put the receiver into bind mode (Refer to the manual of the receiver for details.)
4. The LED of the receiver stops flashing and is solid on, indicating that the binding process is finished.
5. Check to make sure the transmitter and receiver are working normally, repeat steps 1 to 3 (binding process) if any problems arise.

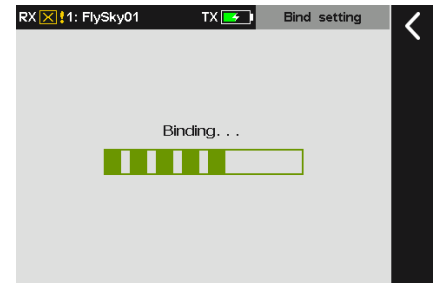

Notes:

1. The binding method may vary with different receiver, For specific binding methods, please visit the official website of FLYSKY for receiver instruction or other relevant information.
2. After the transmitter and receiver establish stable two-way communication, a pop-up window will appear when the receiver is identified as a compatible receiver of a non-FlySky authorized thirdparty brand. Meanwhile, the radio frequency will be interrupted.

5.3 Pre-operation Checks

Always perform the following steps before each operating:

1. Inspect the entire system to make sure that everything is working as expected.
2. Perform a range test as described in the **16.6 Range Test** section of the user manual.

	DANGER	• Do not use the model if there are any abnormal behaviors during the test.
	DANGER	• Do not exceed the maximum rated range during use.
	CAUTION	• Interference from other transmitting devices may reduce signal quality.

5.4 Power Off

Follow these steps to power off the system:

1. Power off the receiver.
2. Press and hold both **Power Switches** on the transmitter, then the screen dims with the prompt "Shut down...please waiting for!", the screen powers off, indicating the transmitter is turned off.

	DANGER	• To avoid any risk of losing control of the model, always power off the receiver before powering off the transmitter.
--	---------------	--



6. Main Interface

This is an introduction about the transmitter's main interface.

6.1 Main Interface Overview

Note: Adjust the menu layout, it is available for version 1.0.65 or later.

The main interface displays information related to the model such as sensor information and function status.

Home1:

The screenshot shows the Home1 interface for a FlySky transmitter. At the top, it displays 'RX [X] !1: FlySky01', 'TX [battery icon]', and 'Home2'. The main area features the 'FLYSKY Paladin PL10' logo and a 'Status Column' with icons for Conditions (C1), Vibration, and Sound. Below the logo, there are three main sections: 'Model Select' (with an airplane icon), 'Custom Menu' (with a lock icon), and a 'Preview of all trim value' area showing 'Routine 18ch' with various trim sliders. To the right, there are buttons for 'Basic', 'Model', and 'System' functions. A 'TX: 3.8V' and 'RX:' section shows battery levels. Callouts on the left identify icons for 'Bind setting', 'Select model', and 'Custom menu'. Callouts on the right explain the 'Status Column' icons and the 'Basic', 'Model', and 'System' function areas.

Status Column: Some function icons are showed if the function is activated in this area, such as **Conditions** (C1), **Vibration** and **Sound**. Different function icons will be shown in this area in various conditions, the details are as follows:

- Airplane: **Airbrake**, **Butterfly**, **Throttle cut** and **Idle up**
- Gliders: **Airbrake** and **Butterfly**
- Helicopters: **Throttle cut**, **Idle up** and **Throttle hold**
- Multicopters: **Throttle hold**
- Cars: **ABS**

Other callouts include: The voltage of transmitter and receiver, The area of entering the Basic function, The area of entering the Model function, and The area of entering the System function.

Home2:

The screenshot shows the Home2 interface for a FlySky transmitter. At the top, it displays 'RX [X] !1: FlySky01', 'TX [battery icon]', and 'Home1'. The main area is divided into several sections: 'TX voltage[0]: Min: 3.5 3.8', 'RX voltage[1]:', 'Signal[1]: RSSI[1]:', and 'SNR[1]:'. On the right, there are two large digital displays for 'Timer display1: Timer 1' (00:00.0) and 'Timer display2: Timer 2' (05:00.0). Below the displays are two empty boxes for 'Sensor 8 Setup' and 'Sensor 7 Setup'. Callouts on the left identify icons for 'Sensor 1 Setup' through 'Sensor 6 Setup'. Callouts on the right identify 'Transmitter Power Status', 'Lock/Unlock Icon', and 'The icon of entering the Home1', 'Timer1', 'Timer2', 'Sensor 8 Setup', and 'Sensor 7 Setup'.



微信公众号



Bilibili



Website



Facebook

6.1.1 Status Bar (Top)

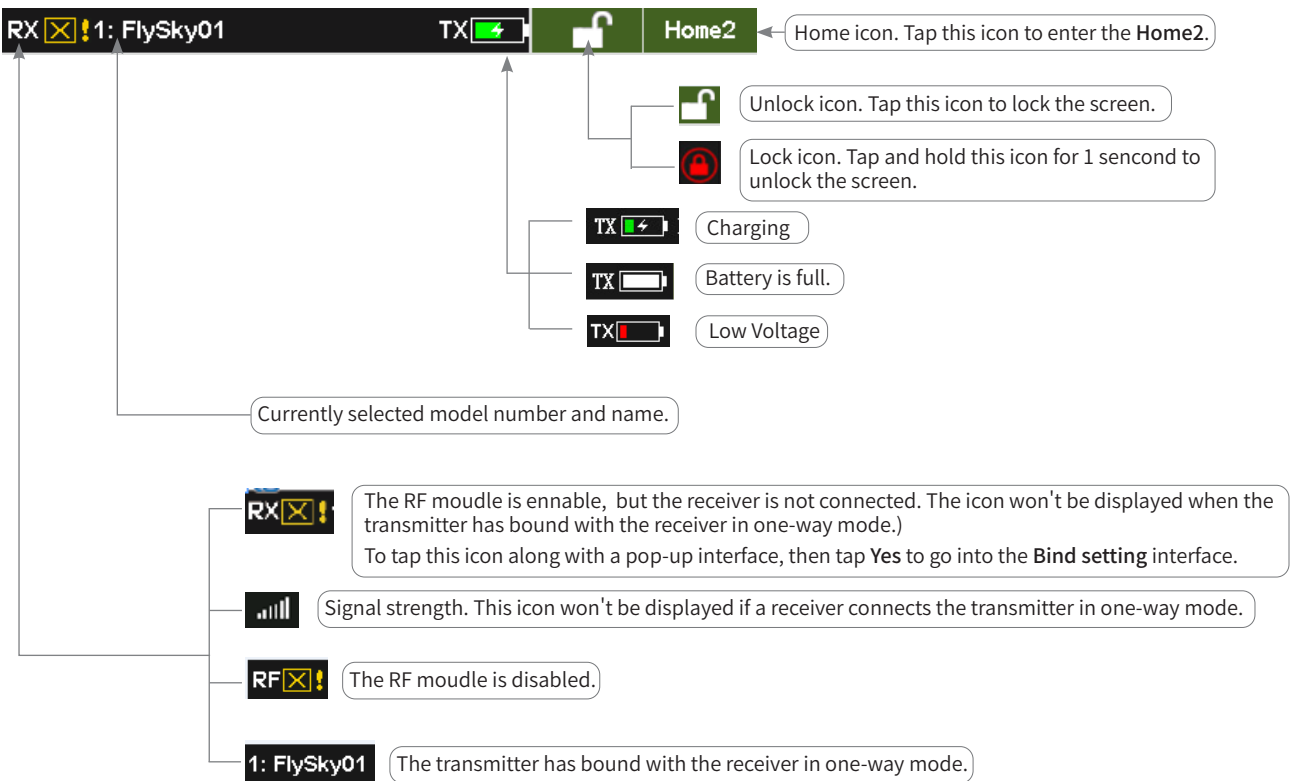

6.1.2 Quick Access

Home1:

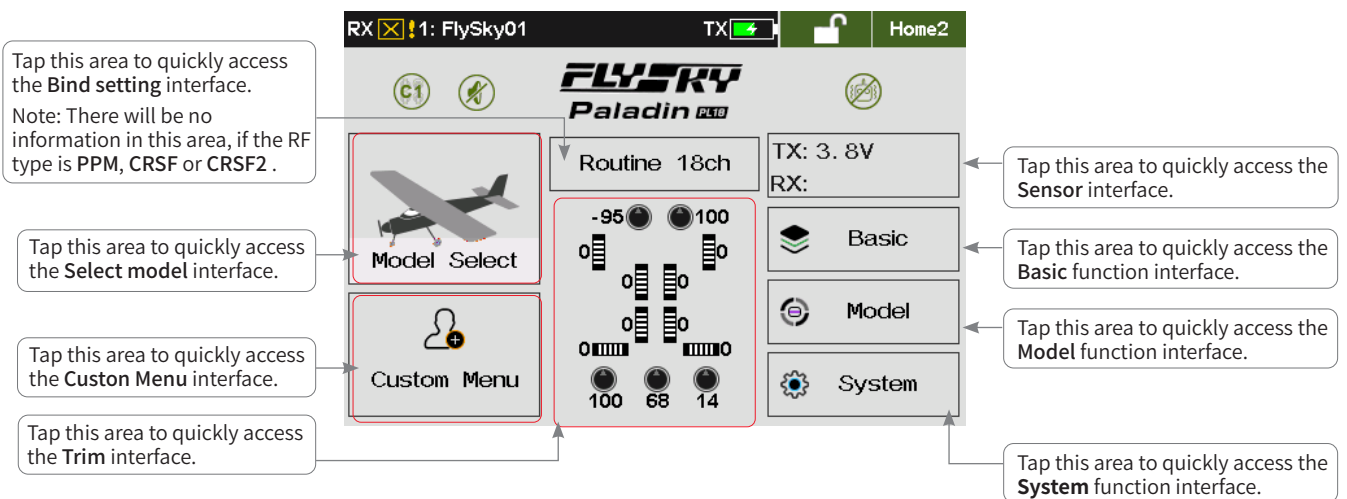



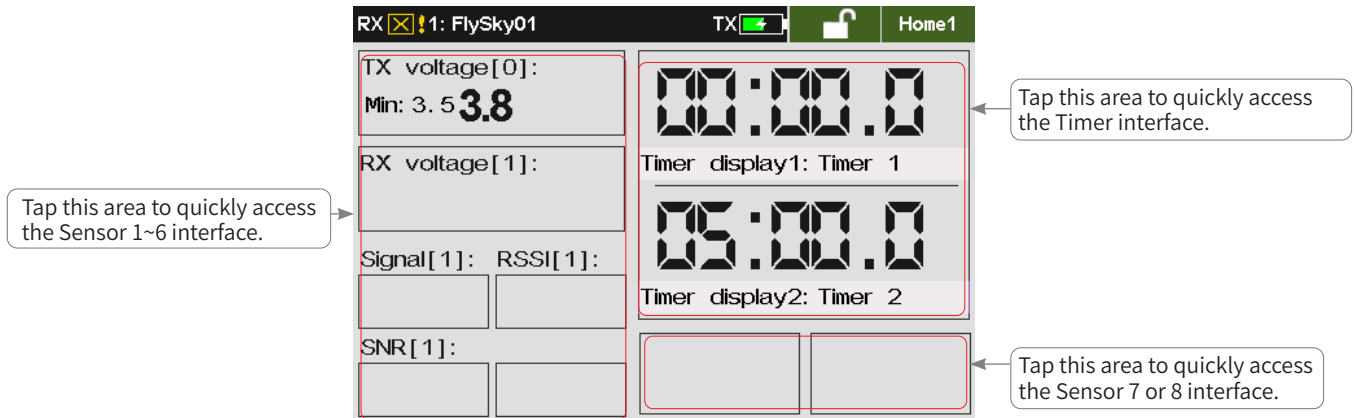







Home2:



6.2 Interface

This section is a quick introduction about the icons of the interface.

6.2.1 Function Icons

	Indicates that the function is locked.		Indicates that the function is unlocked.
	Function disabled		Function enabled
	Restore to the default		Go Back Icon
	To increase the value		To decrease the value
	For all conditions		For the current condition
	Assign switches		



7. Basic Settings

Note: Adjust the menu layout, it is available for version 1.0.65 or later.

This chapter introduces the settings of basic function mainly in default condition. You can access **Basic** function interface via **Home1 > Basic**.

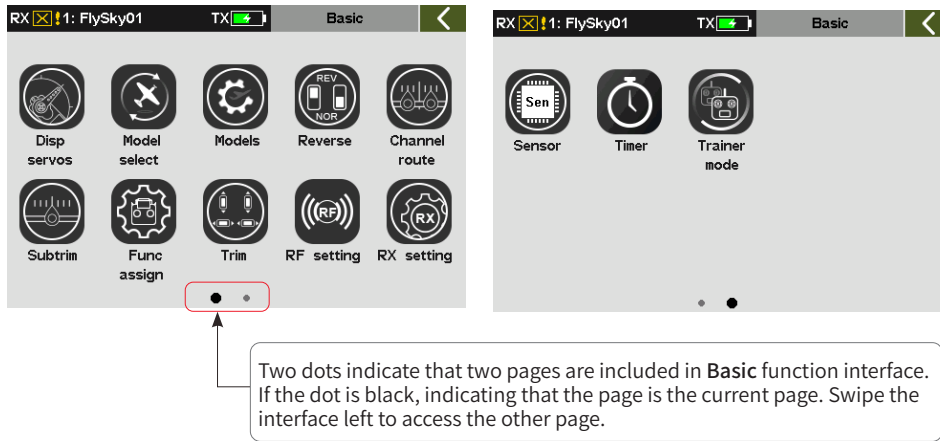

7.1 Display Servos

Note: To show the information of all channels in a page, it is available for version 1.0.65 or later.

To display the real time output value of each individual channel.

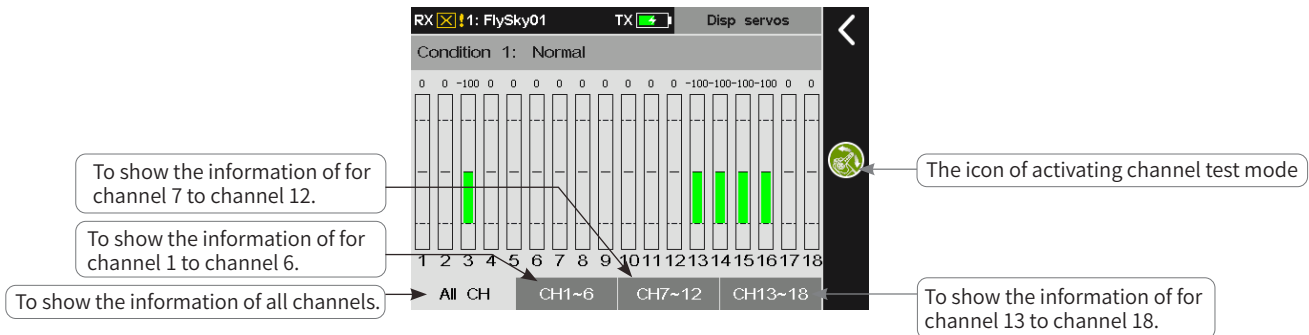

7.1.1 Display Servos

To display the real-time output value of each individual channel.

Function setup:

1. Access **Display servos**.
2. Toggle or press the **Switch/Knob** assigned to the channel.
3. Monitor the output value of the channel in **Display servos** interface.
4. Click to return to the previous interface.

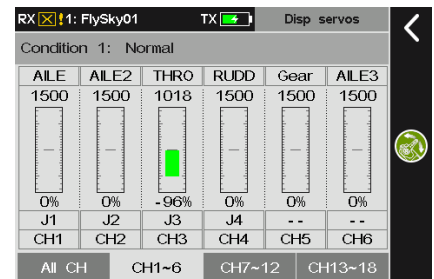

7.1.2 Channel Test

To activate the mode of testing all channels.

Function setup:

1. Tap to activate channel test mode. A prompt interface appears, then press **Yes** to start. When test mode is active all channels will slowly move through their entire range of motion.
2. Click to return to the previous interface.

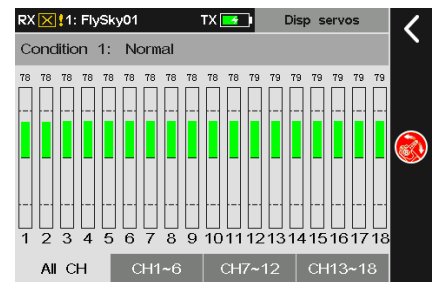

DANGER	<ul style="list-style-type: none"> • When the mode of testing all channels is enabled, propellers/rotary wing of models will rotate unexpectedly. It is very dangerous! Do not activate this function when the transmitter is connected with the models or the engines of the model is started.
---------------	---



微信公众号



Bilibili



Website



Facebook

7.2 Model Select

Note: This function is available for version 1.0.65 or later.

This function is used to create a new model by Copy or New function, delete all models except the current model, or search the receiver corresponding to the model. The settings of the models vary for the different models. This function provides opportunities that one transmitter can adapt varieties of real models.

The interface for the model which is operating currently

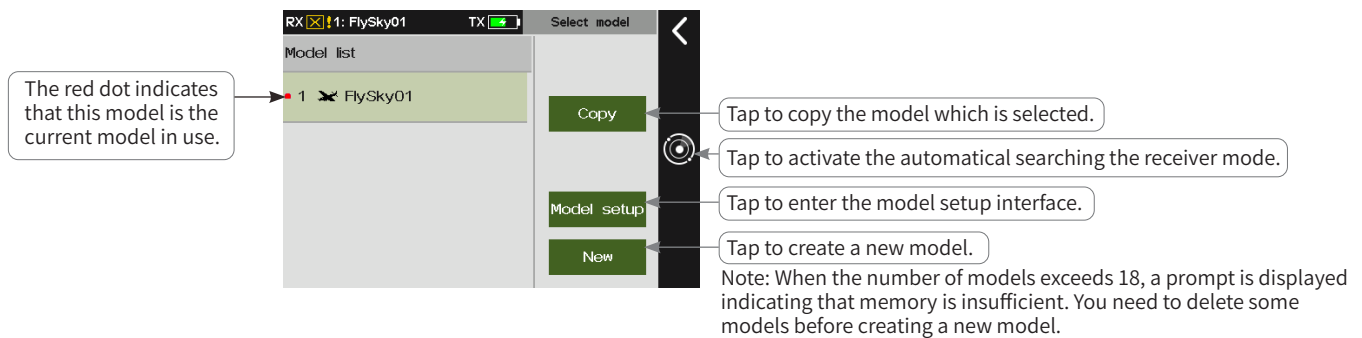

The interface for the model which is not in use currently

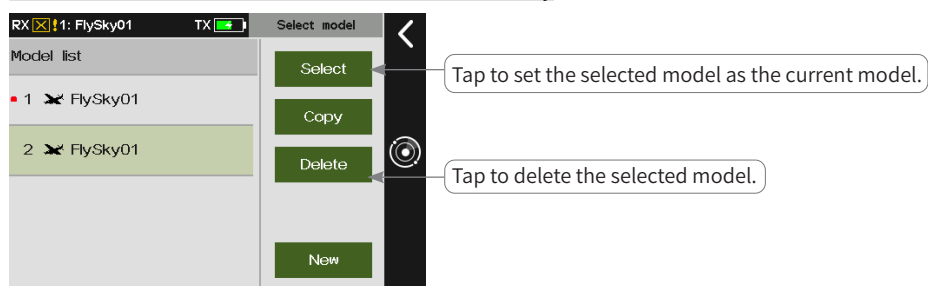

7.2.1 Automatical Searching For The Receiver

To search for the power-on receiver which has bound with the transmitter already. After tap , the system will sequentially switch models to synchronize the receiver under this model.

Function setup:

1. Power on the receiver.
2. Enter **Select model** interface.
3. Tap  at the right of the interface to search for the receiver automatically, and a prompt window comes along with it, press Exit to stop searching.
4. After the searching process is completed, the red dot will move to the model which is corresponding to the receiver. And the transmitter has connected the receiver normally.

Notes:

1. The RF module needs to be enabled.
2. Ensure that the receiver only binds with one mode, and duplicate models may not be searched.

The interface before searching

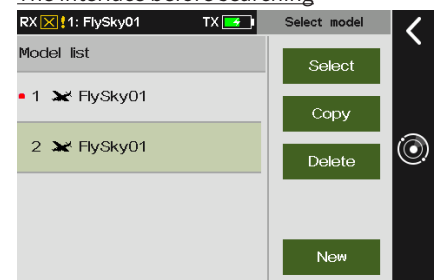

The interface after searching

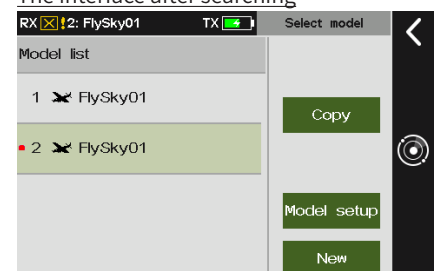

7.2.2 Copying A Model

To copy the data of the selected model to another model.

When a new model is to set up, you can use this function to copy existing model data and then modify different parts without repeating the settings. It is very convenient.

Function setup:

1. Enter **Select model** interface.
2. Tap the model that you want to copy.
3. Tap **Copy** and click **Yes** on the pop-up interface to complete a copying model. Afterwards, click  to return to the previous interface.

Note: After copying model is completed, the new model is selected by default, it is the last one in the list.

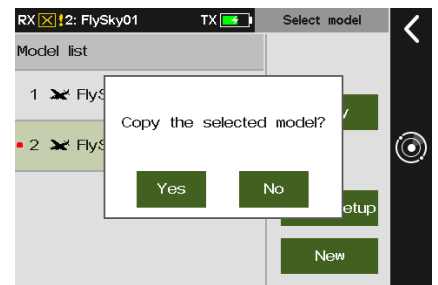

7.2.3 Create A New Model

To create a new model.

Function setup:

1. Enter **Select model** interface.
2. Tap **New** and click **Yes** on the pop-up interface to create a new model. Afterwards, click  to return to the previous interface.

Note: After copying model is completed, the new model is selected by default, it is the last one in the list.



7.2.4 Selecting A Model

To set the selected model as the model currently in use.

Function setup:

1. Enter **Select model** interface.
2. Tap the model that you want to set.
3. Tap **Select** and click **Yes** on the pop-up interface to complete. the red dot will move to the selected model. Afterwards, click  to return to the previous interface.

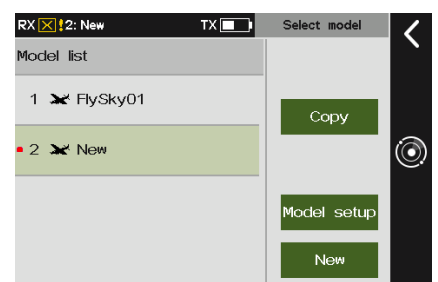
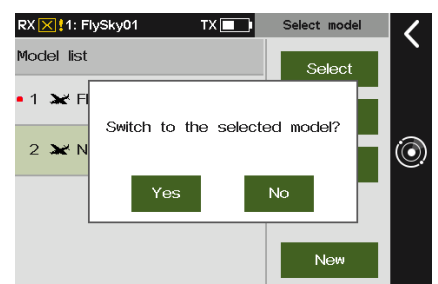

Be aware: Model data can be inherited through FlyskyAssistant (FlyskyAssistant firmware Ver. 3.0 and higher)



微信公众号



Bilibili



Website



Facebook

7.2.5 Deleting A Model

To remove a model from the memory of the transmitter .

Function setup:

1. Enter **Select model** interface.
2. Tap the model that you want to delete.
3. Tap **Delete** and click **Yes** on the pop-up interface to complete. Afterwards, Tap **Back** to return to the previous interface.

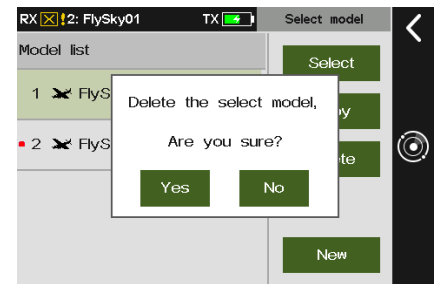

Note: The model currently in use can not be deleted.

7.3 Model Setup

Note: This function is available for version 1.0.65 or later.

DANGER

- Before operating, make sure to check whether the status of each channel is safe. If the channel is not in safe state, this may lead the destroy to the structure of the airplane. Or if the model airplane starts directly, it may lead to personal injury or other accidents.

PL18 transmitter includes a variety of options for modes, including Airplanes, helicopters, gliders, multicopters, cars, boats and robots. You can set the related settings of models, such as configurations and functions.

Tap to enter the interface of renaming model's name.

Tap to enter the interface of selecting stick mode.
Note: For car, robot or ship models, the stick mode is set to mode 2, and can not be set.

Tap to enter the interface of selecting model type.

Tap to enter the interface of selecting wing,tail and optional functions.

Tap to enter the interface of selecting model picture.

Tap to reset all data of the model.

Note: For Airplane/Glider, Tap the area to enter Wing and Tail setting interface. For Car/ Robot, to enter move setup interface, and for Helicopter, to enter Swash plate setting interface. While for Ship and Multicopters, nothing is displayed here, and you cannot Tap.

Model Type Setup

Sets model type and related parameters and functions. For **Airplane/Glider**, you can set **Wing**, **Tail** and **Optional**. For **Helicopter**, you can set **Swash plate** and **Optional**. For **Car** and **Robot**, you can set **Move setup** and **Optional**.

Note: If the model type is changed, the model data will be reset and the sub-configuration will be changed, as well as the function assign interface will be changed accordingly.

Model Categories
Show the default picture of the model.

Model sub-configuration
The function item is different due to different model category.

Shows the corresponding item, after the model category and model sub-configuration have been selected.



The parameters and optional functions for different model type may differ.

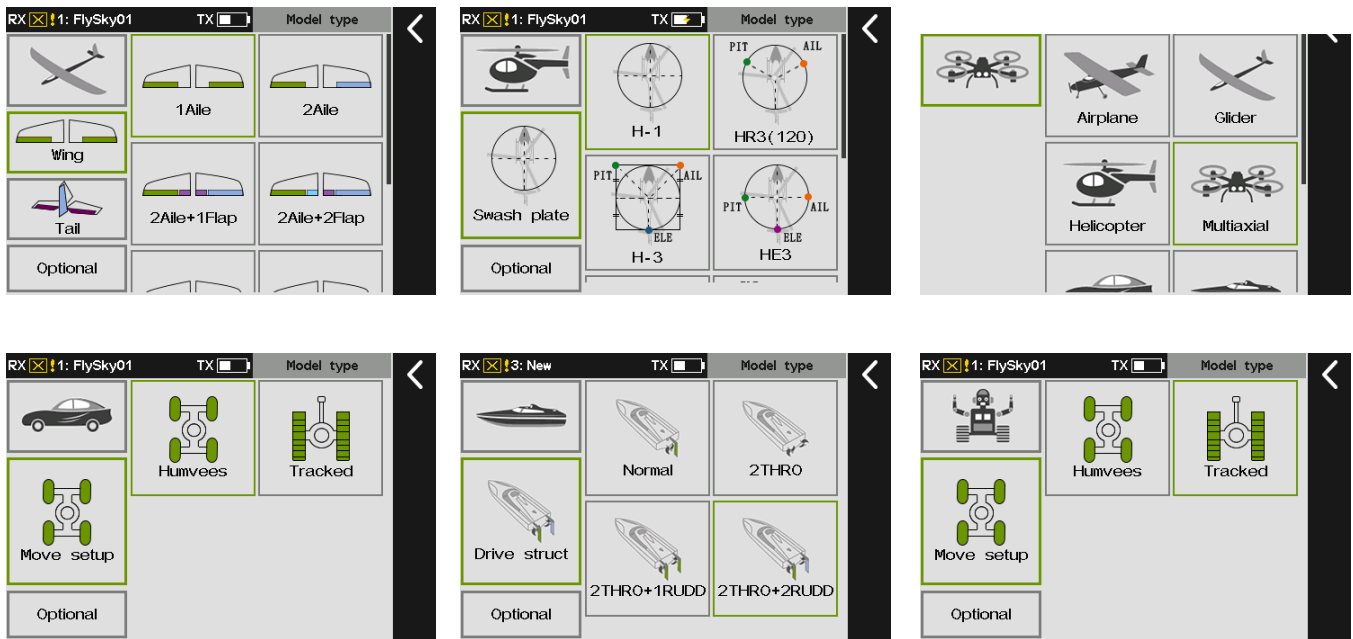

Take the airplane for an example, the setting steps are as follows. For the related setting of other models, refer to the steps below.

Function setup:

1. Enter **Model type** interface.
2. Click **Wing** directly as the airplane is the default model, then Tap the appropriate wing configuration according to the actual model. Afterwards, it goes to the next setting automatically.
3. Click the appropriate tail configuration according to the actual model, then it goes to the next setting automatically.
4. Click the appropriate function item according to the actual model. Afterwards, click to return to the previous interface.

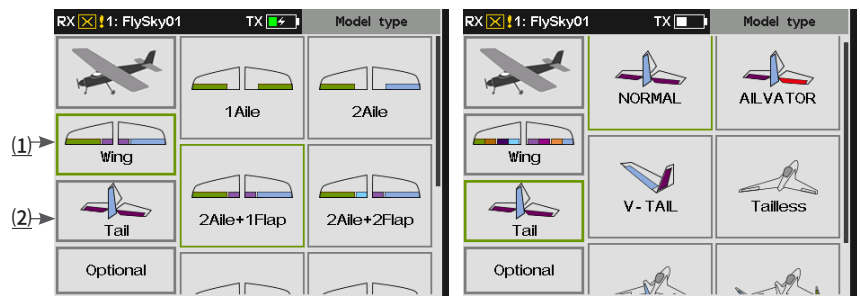

(1) Wing configuration

(2) Tail configuration

Note: For Tail configuration, when you set two ailerons or above for the Wing, then some configuration items related to tailless will display.



Tap to set the quantity. You can set more than one for some functions, for the Throttle, there are up to 4.

Note: The optional function items vary with different model types. For example, for the Airplane, you can set the Rudder wheel, Gear and so on, but for the Ship, the Wave and the Grip can be set.



微信公众号



Bilibili



Website



Facebook

For Helicopter, follow the steps below to change the swash plate type.

1. Enter **Model setup** interface.
2. Tap **H-1**.
3. Tap the appropriate swash plate according to the actual model. Afterwards, click  to return to the previous interface.

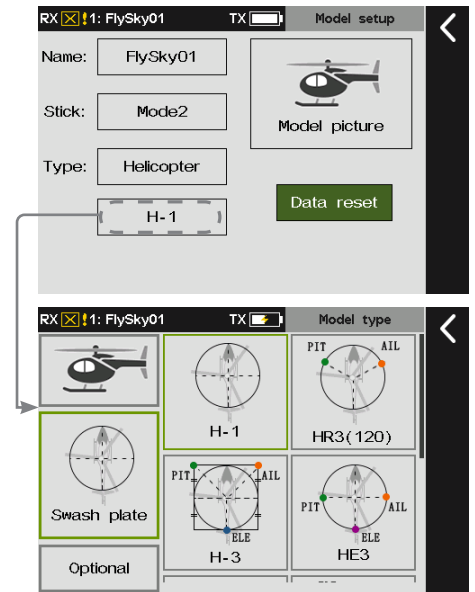

For Car or Robot, follow the steps below to change the move setup.

1. Enter **Model setup** interface.
2. Tap **Humvees**.
3. Tap the appropriate item according to the actual model. Afterwards, click  to return to the previous interface.

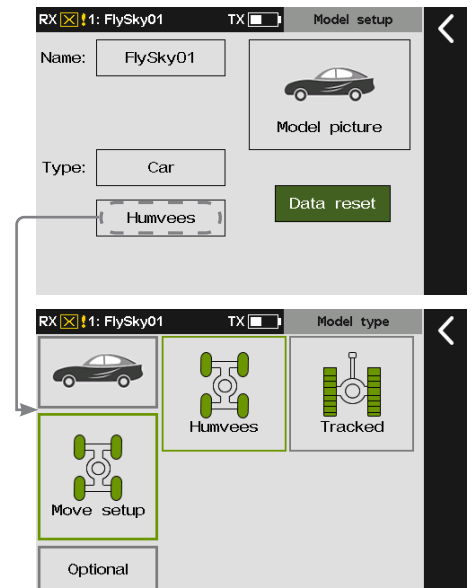

7.4 Reverse

To reverse the output direction of each channel.

This function can be used to correct the direction of the servo action which is opposite to the intended operation. Due to different servo types or servo installation methods, servo directions can be set for 18 channels.

Normal: Indicates that the channel output is the default direction.

Reverse: Indicates that the channel's direction has been reversed.

Notes:

1. If a new model is connected, make sure the corresponding channel of the servo is correct.
2. Move the stick, switch or knob related to channels to make sure that the direction of each channel is correct.

Function setup:

Tap the box at the right of the channel name to toggle reverse for that channel. If there is a tick in the box it means that the channel is reversed.

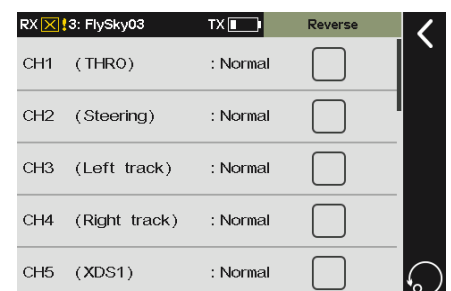

7.5 Channel Route

Note: Add channel range (Up/Down) to channel route for version 1.0.49 or later.

Changes the max range of movement and the movement range limitation (minimum value, maximum value) for each channel.

End is used to set the max of movement value for the travel range of the servo. **Range** is used to set the limited value for the travel range. After **Range** is set, even if the mixing function increases the travel value of the servo, the servo movement range will not exceed the range value, thus to protect the servo.

When the servo neutral position deviates too much from the position required for the configuration, the position adjustment will not achieve a desired effect by this function. Please adjust the servo neutral position first.

With this function, you can adjust the maximum servo movement of 18 channels respectively.

The green bar is the current position of the control, and the gray areas are for the set up and down ranges, and the green triangles are for the set up and down endpoints.

- Tap to select the UP End.
- Tap to select the UP Range.
- Tap to select the DW End.
- Tap to select the DW Range.

Note: The endpoint value should not be greater than the range value.

Click a channel to enter the next setting interface corresponding to this channel.

Sets the range value below the channel neutral position.

Function setup:

1. Tap the channel to be adjusted and enter the setting interface.
2. Tap DW Range 120%.
3. Click + or - to set the appropriate travel range value. Afterwards, click to return to the previous interface.

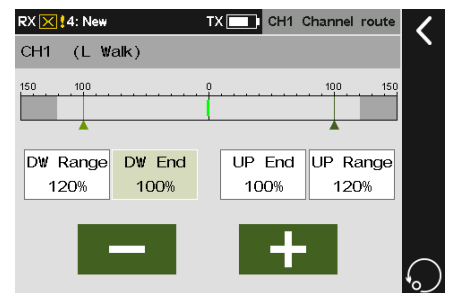

For Low End, Up Range and Up End, refer to DW Range for function settings.

7.6 Subtrim

To adjust the neutral position of each servo.

This function can be used to solve the problem of angle difference between the servo and model structure when the servo is installed, or due to the structural inherent clearance of the servo. When you set the subtrim, toggle the trim to the neutral position first.

Function setup:

1. Click a channel you want to adjust to enter.
2. Click + or - to adjust the neutral position value of the channel to the desired point. Then, click to return to the previous interface.

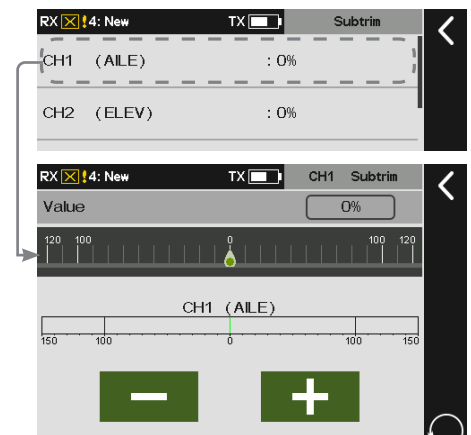

微信公众号



Bilibili



Website



Facebook

7.7 Function Assignment

Note: The TEL option is added for version 1.0.70 or later.

Assign all the controls and trim buttons corresponding to the functions. By default, the functions are assigned by model types after a new model is created. You can set the function here if you want to assign according to your habits.

CR	Function	Control	Trim
1	AILE	J1	TR8
2	ELEV	J2	TR6
3	THRO	J3	TR5
4	RUDD	J4	TR7
5	Gear	--	--

Trim Preview

Control Preview

Note: The Control/Trim name is red, indicating that the control/Trim is assigned.

Select the function to assign a control or trim.

Set the specific trim button for this function. If the small triangle at the bottom right of the function box is cyan, the setting is for all conditions. If it is orange, the setting is for the current condition.

Set the specific control for this function. If the small triangle at the bottom right of the function box is cyan, the setting is for all conditions. If it is orange, the setting is for the current condition.

7.7.1 Assigning Function Items

To select a function which need to be assigned a control.

Function setup:

1. Tap the function that needs to be set and enter the next interface.
2. Tap the appropriate function.
3. If you want to create a **AUX.**(auxiliary) channel for the the control, tap **Custom:(AUX.1)** and enter a appropriate name on the pop-up interface, then, click to return to the previous interface.

Note: The custom channel name should be defined separately for different languages.

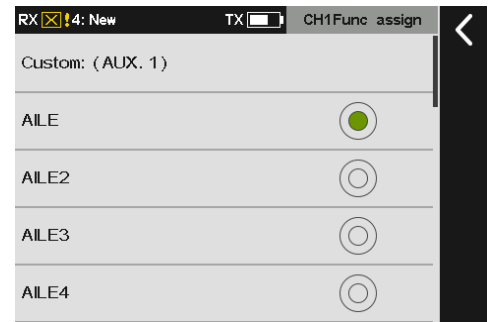

7.7.2 Control Assign

To assign a specific control for the function selected.

The controls that can be assigned are **SWA~SWG** switches, **LS1~LS4** logic switches, **J1~J4** sticks, **VRA~VRE** trim knobs and **TEL** telemetry controls.

Function setup:

1. Tap the control you want to assign to enter the setting interface.
2. Tap **Control** on the interface or toggle the control on the transmitter to select it. Then the control assignment is completed.

Note: If you want to assign a logic switch for the function, you can only complete by Taping the LSW on the interface: Click the LSW on the interface, then Tap the appropriate LSW.

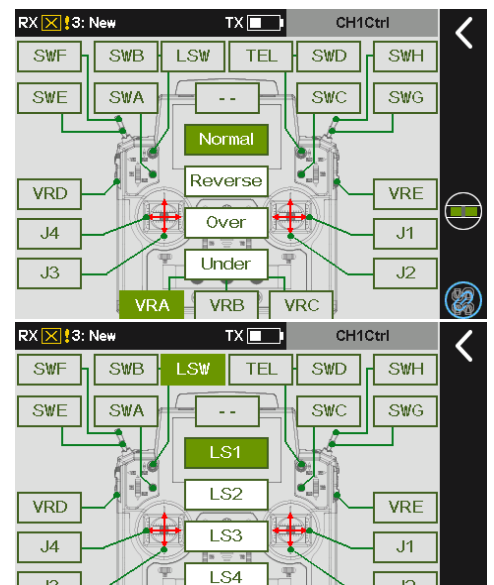

You can set the related parameters after the control assignment is completed. The parameters are different for different controls.

- For **J1-J4** or **VR** consecutive kind switches, you can select **Normal**, **Reverse**, **Over** and **Under**.

Normal means that the corresponding control ratio changes from "-100% to 100%" when the control is moved from "down" to "up".

It is conversely for **Reverse**. In other words, When the consecutive switches are moved from "down" to "up", the corresponding control ratio changes from "100% to -100%".



For **Over** (Up side) or **Under** (Down side),

The control ratio only switches between -100% and 100%, and the middle area is the hysteresis area.

Selecting **Up side** means the control ratio is 100% in the high position and -100% in the low position. It is conversely for **Under**.

Take **VRA** as an example.

Function setup:

- Tap **VRA**, then click **Normal** or **Reverse**.
- Click **Over**, then click  to enter the next interface. After selecting **Down side** or **Up side**, the selected function item turns to light green, click **+** or **-** to adjust the **Up-side** and **Down-side** values to the desired point. Then, click  to return to the previous interface.

Note: You can click  to choose to set only for the current condition or set for all conditions.

- For switches named after **SW** characters, you can set **Normal** or **Reverse**.

Normal means the control ratio is -100% when the control position is in the low position and 100% when the control position is in the high position (the neutral position control ratio in the three-level switch is 0%).

It is conversely for **Reverse**. In other words, the control ratio of **SW** switches is 100% in the low position and -100% in the high position.

- For Logic switches, you cannot set the parameters when the control is **ON**, it means the control ratio is 100%. **OFF** means the control ratio is -100%.
- For **TEL** control, you can set the parameters in **Telemetry Control** function, to use the realtime value obtained as a control.

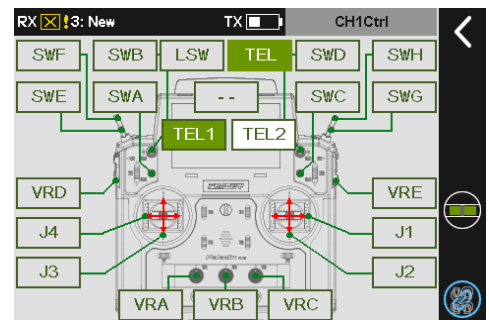
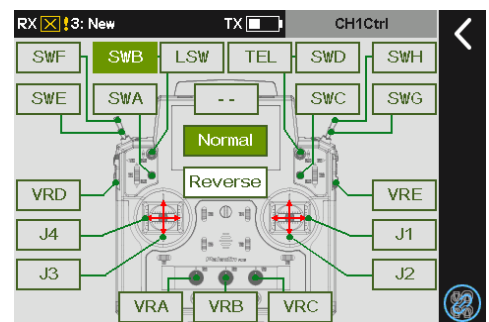
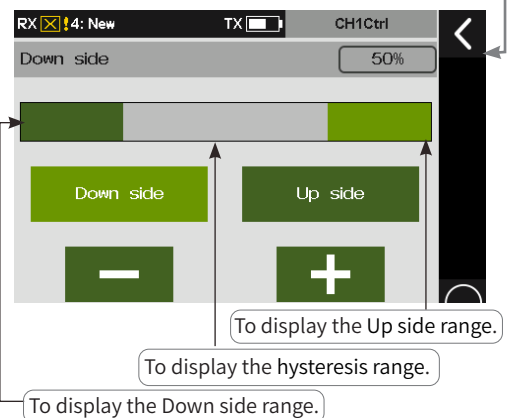
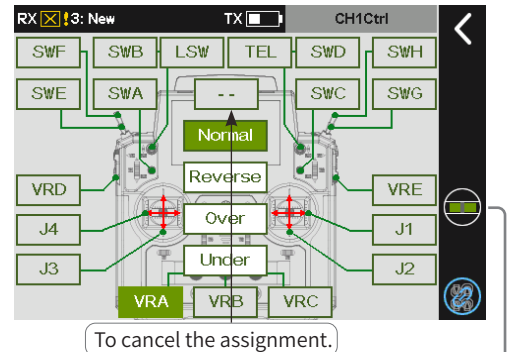

微信公众号



Bilibili



Website



Facebook

7.7.3 Function Trim Assignment

To assign a trim button for a function which you desired.

Function setup:

1. Enter **Trim** interface,
2. Tap the trim button on the interface or toggle the trim button you want to assign. Then the trim assignment is completed.

You can set the related parameters for the trim button after the trim assignment is completed.

Trim mode and **Trim rate** can be set.

In the **trim mode**, you can select **Normal**, **Cen Max** (center MAX), **H-Max**(high-end MAX)and **L-Max**(low-end MAX). **Normal** means normal trimming (linear) operation. **Cen Max** means the maximum trim adjustment in the neutral position, and no trim adjustment in the low and high positions. **H-Max** means the maximum trim adjustment in the high position, and no trim adjustment in the other positions. **L-Max** means the maximum trim adjustment in the low position, and no trim adjustment in the other positions.

Trim rate A total travel range of the channel that can be controlled by the trim knob. A negative value indicates the reverse.

Note: The setting of trim rate is the same as that of trim mode in all the other modes. When the trim is not assigned, the trim setting cannot be set and the parameters that have been set will be kept.

Follow the steps below to set:

1. Tap **Trim setting** to enter the trim setting interface.
2. Click the option box on the right of **Trim mode**, and select the appropriate trim mode according to the description above.
3. Tap **Trim rate** and click **+** or **-** to adjust the trim rate value to the desired point. Then, click **↩** to return to the previous interface.

Trim assignment screen for no trim button selected.

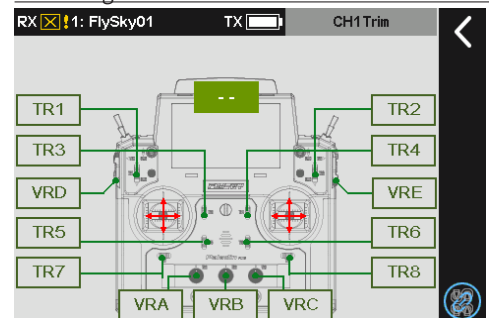

Trim assignment screen for a trim button selected.

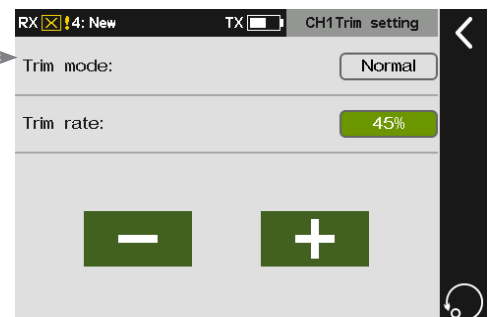
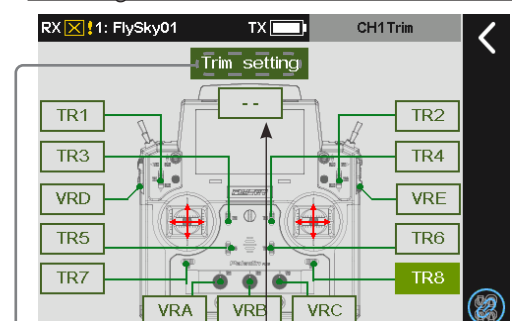

7.8 Trim

Note: This function is available for version 1.0.65 or later.

You can view the trim values of **TR1** to **TR8** and **VRA** to **VRE** in this preview interface. For **TR1** to **TR8**, you can set the appropriate step value and the backup trim value for current condition/all condition. And for **VRA** to **VRE**, you can only set the backup trim value.

During use, a model control surfaces may occur a deflexion based on some situations, such as centre-of-gravity shift or anti-torque force produced by aerodynamics. You can use this function to correct it during flight to keep stable state. Please re-adjust the model in case of the overall excessive offset of the model cannot be corrected by trims function.

Tap a Trim button (TR1-TR8) to enter the setting interface.

Tap / to lock or unlock the trim function. That is, when toggle or turn the buttons in case of the icon is red, the values recorded in the system won't be changed.
Note: For VRA to VRE buttons, when unlock the trim function, the system will obtain the trim value from the current position of the trim button at once.

If the edge colour is cyan, it indicates the trim value is for the all conditions.

If the edge colour is orange, it indicates the trim value is for the current condition.

Tap a Trim knob (VRA to VRE) to enter the setting interface.

7.8.1 Setting TR1 Trim

Sets the trim step value. You can set it for all conditions or for the current condition. It is only supports one-time storage.

Backup and call setting for TR1 trim button

Sets backup value for **TR1** trim button.

Function setup:

1. Tap **TR1** to enter the setting interface, the previous set backup value is displayed in **Backup trim** area.
2. Push or pull the **TR1** button on the transmitter to a desired value.
3. Click **Rebuild** to set it to the backup value.
4. Click **Call** to call the backup value. Then click to return to the previous interface.

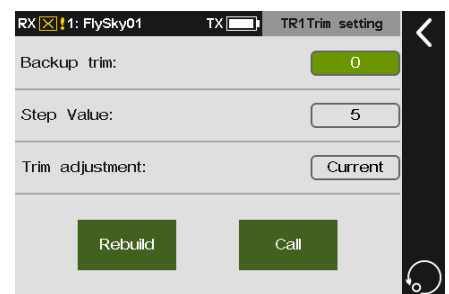

Step value setting for TR1 trim button

Sets step value for **TR1** trim button.

Function setup:

1. Tap **TR1** to enter the setting interface.
2. Click **Step Value**, click **+** or **-** to adjust the value to the appropriate value. Then click to return to the previous interface.

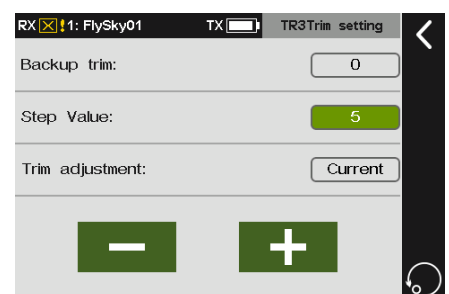

微信公众号



Bilibili



Website



Facebook

Trim adjustment setting for TR1 trim button

Sets trim adjustment for TR1 trim button.

1. Tap **TR1** to enter the setting interface.
2. Click **Trim adjustment** and click **Yes** to adjust the condition. Then click  to return to the previous interface.

Note: When for all conditions is activated, trim values in all conditions will call the current trim value. Please operate with caution.

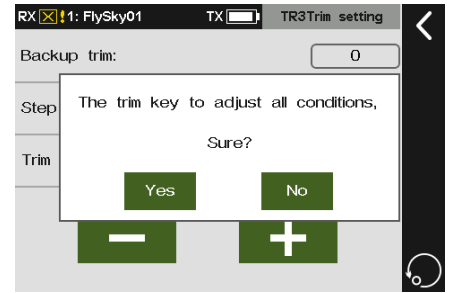



For **TR2** to **TR8** settings, please refer to the relevant settings of **TR1**.

7.8.2 Setting VRA Trim

Sets the backup trim value. The backup value is for reference only and can not be called.

Function setup:

1. Tap  to enter the setting interface, the previous set backup value is displayed in **Backup trim** area.
2. Turn **VRA** clockwise or counterclockwise to adjust the trim value to the desired value. Then, click  to return to the previous interface.



For **VRB** to **VRE** settings, please refer to the relevant settings of **VRA**.



7.9 Sensors

Note: This function is available for version 1.0.65 or later.

To set the related data of the transmitter and the receiver, as well as the data returned by internal and external sensors, and so on.

7.9.1 Displaying Sensors

This list shows all sensors connected, including sensor type, number and real-time data.

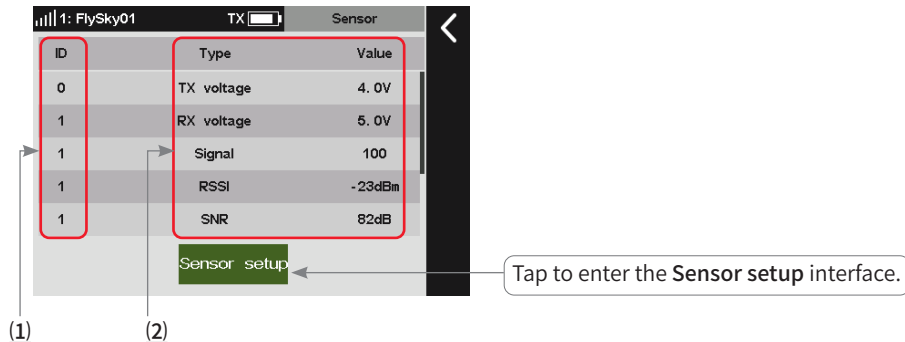

(1) Display Sensor ID

To display numbers of sensors. By default, the ID number 0 represents the transmitter, and the ID number 1 represents the receiver or the primary receiver (two receivers connected). And for ID number 2 represents the slave receiver or the first external sensor connected to the receiver, and so on. This list data is displayed in real-time. When a sensor is connected to the receiver, this list will be refreshed to display the new sensor's ID. And when the sensor is disconnected, the ID related to this sensor will disappear.

(2) Display Sensor Type and information returned from receiver

This list data is displayed in real-time. When a sensor is connected to the receiver, this list will be refreshed to display the new sensor's type and information. And when the sensor is disconnected, the type and data related to this sensor will disappear.

The following is the descriptions about the parameters of the transmitter and receiver.

TX Voltage: To display the voltage for the transmitter's battery.

RX Voltage: To display the power supply voltage for the receiver.

Signal (strength): To display the signal strength between the transmitter and the receiver. It is calculated by using SNR. The signal strength will be displayed as a value between 0 and 100. In the same environment, the farther the distance, the smaller the value. If the signal strength drops to 4 or below, the system will alert the user.

SNR: The signal-to-noise ratio refers to the decibel difference between the signal and the noise received by the receiver. The signal-to-noise ratio equals the data of RSSI subtract the data of Noise, which is a decisive parameter in the overall quality of the signal. If the SNR drops below 11, reduce the range quickly to prevent loss of control.

RSSI: indicates the power of the signal received by the receiver. 0 to -40 dBm: Indicates that the distance between transmitter and receiver is close and the communication quality is best. -40 dBm to -85 dBm: The communication quality is good. Less than -85 dBm: Indicates that there is an obstacle between the transmitter and receiver or the distance is far. Please shorten the control distance to avoid losing control.

Noise: Noise is generated due to interference from other nearby transmitters such as WIFI. In places where there are too many transmitters, excessive noise will affect the remote-controlled distance.



微信公众号



Bilibili



Website



Facebook

7.9.2 Sensor Setup

Sets the sensors displayed in **Home2**. You can set the alarm threshold for a selected sensor, or perform the special sensor settings.

You can set the alarm function of the sensor connected to the transmitter. After the settings, the real-time value may trigger an alarm. In case of a sensor with an extreme value, the extreme value can be displayed and the extreme value can be cleared through a switch setting.

Selects a sensor and sets its parameters.

Changes the sensor displayed here. Take **TX voltage** as an example. You can set two groups of alarm voltages. The extreme value can be displayed if the sensor supports extreme value and the extreme value can be cleared through a switch setting.

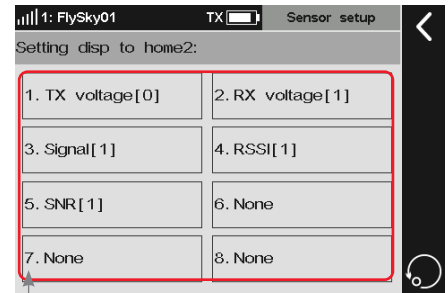

Tap sensor 1 ~ sensor 8 to enter the corresponding sensor setting interface respectively.

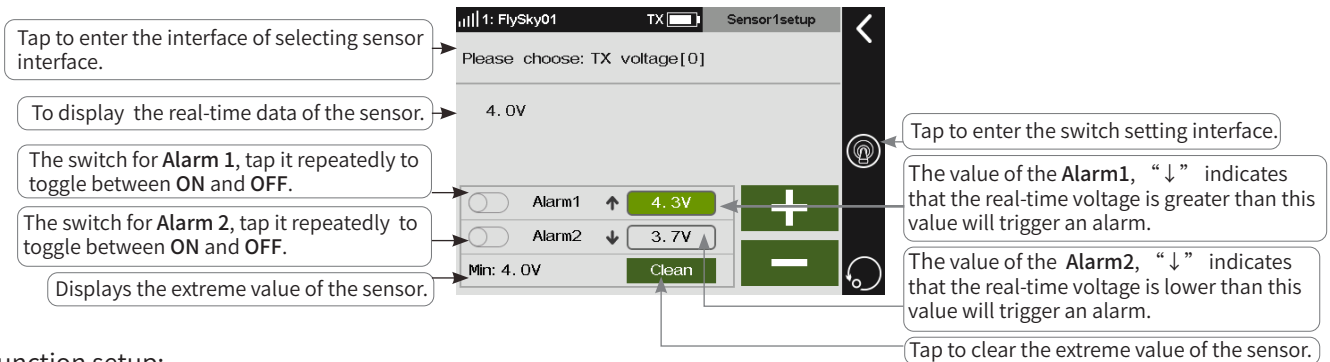

Function setup:

1. Click **1.TX voltage [0]** to enter the setting interface.
2. To change the sensor displayed here, click **Please choose: TX voltage [0]** to enter the setting interface. Select the sensor to be displayed. Click to return to the previous interface.
3. You can set two groups of alarm voltages. Select **Alarm 1** or **Alarm 2**. Then click **+/-** to set the appropriate value.
4. Click **Clean** to clear the extreme value, or click to set the switch for clearing the extreme value. Click to return to the previous interface.

Notes:

1. The setting only takes effect for the current sensor. When you select a different sensor, the set parameters will be cleared. You cannot select a sensor that is not connected. If a sensor is not connected, you should not select the sensor.
2. The extreme value is the minimum value recorded at the last power-on operation. After clicking Clean, the displayed extreme value changes to the minimum value at the current state. Some sensors may not support the settings of the extreme value. Some detected values are maximum, some are minimum, while some sensors are not supported to detect extreme valve.
3. Sensors may vary with alarm types. For example, the signal strength only supports the alarm below the set value. In this case, the first triggered alarm value causes a low alarm frequency (once a minute). When two alarm values are triggered, there is a high alarm frequency (once every ten seconds). While for the sensor which supports one alarm below the set value and the other above the alarm, when the alarm value is triggered, the frequency is once every ten seconds.
4. For special sensor settings, the entrance will be in the real-time parameter display area.

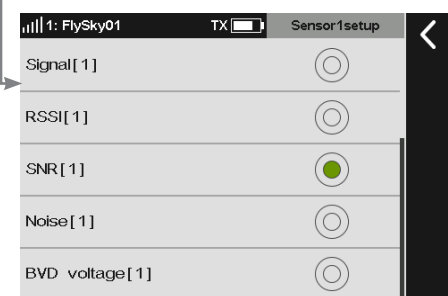
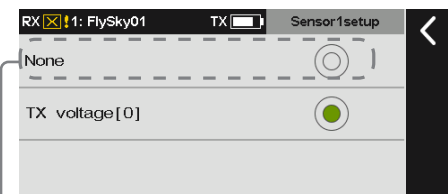

Note: To display the sensor connected. If a sensor is not connected, you should not select the sensor.

For other sensor setting, refer to the related setting of **TX voltage**.



The following descriptions are installations and function settings about some i-BUS sensor modules. Take the FTr10 receiver and the PL18 transmitter as an example, connect the sensor to the SENS interface of the FTr10 receiver, and the other sensor can be connected to the IN interface of this sensor in turns. The connection diagram between the sensors and the receiver is as shown below.

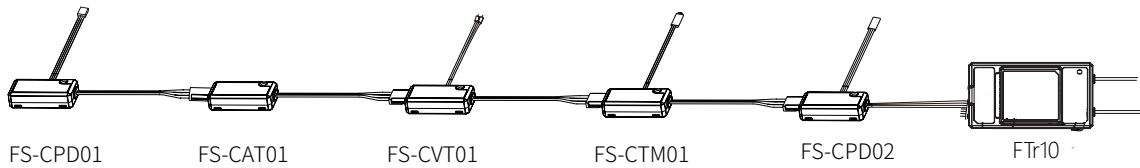

Notes:

1. For the enhanced receiver, before connecting the sensor to the receiver, you need set the output signal type for NPA(Newport A) to i-BUS-IN via Basic > RX setting > Custom port protocol first.
2. The abbreviations for the Newports are for NPA, NPB, NPC and NPD, the receiver supports up to 4 newports.
3. The system only supports one Newport interface is set to i-BUS-IN, and at the same time the other newports cannot be set to i-BUS2.

FS-CPD01: Magnetic Induction Speed Acquisition Module

Be used to measure the speed of the motor. Monitor the real-time data of detection through the **Sensor** interface.

Installation steps:

1. Place the sensor next to the magnet, which is fixed to the spinning part of a model such as the blades of a plane rotor.

Note: Make sure that the sensor is within 2mm of the magnet and the north pole or south pole of the magnet is parallel to the sensor.

2. Connect the FS-CPD01 sensor to the **SENS** interface of the FTr10 receiver.
3. Turn on the transmitter and enter **Home1 > Basic > Sensor**. Try to turn the gear around, if the **RPM-SP** value changes, then the installation is successful, otherwise repeat the above steps.

Note: RPM-SP means the sensor is testing the speed of the motor. 3 is the sensor ID and refers to the third sensor. 12rpm is the speed measurement value.

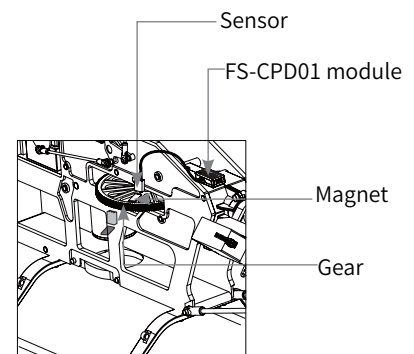

The interface of the **RPM-SP[3]** is shown at the right. For the **Alarm** and **extreme value**, refer to the related setting of the **TX voltage**. For the setting of **RPM**, follow the steps below:

Function setup:

1. Tap to area showed on the picture to enter the setting interface.
2. Click the function box right to the **Gear ratio** to select it. Click **+/-** to set the appropriate value.
3. Click the function box right to the **Wheel CIR** to select it. Click **+/-** to set the appropriate value.

Notes:

1. The gear ratio is the rate of the number of gears of the actual detection speed to the number of gears of the target monitoring speed.
2. When it is not convenient to install a sensor for a device with the pre-monitoring speed, you can try to monitor the rotational speed of the device by testing the rotational speed of the drive components and setting the appropriate gear ratio. For example, monitor the speed of the rotating shaft by monitoring the rotational speed of the paddle.
3. For a wheeled vehicle model, the speed of the vehicle can be obtained based on the set wheel circumference and the rotational speed value of the wheels.

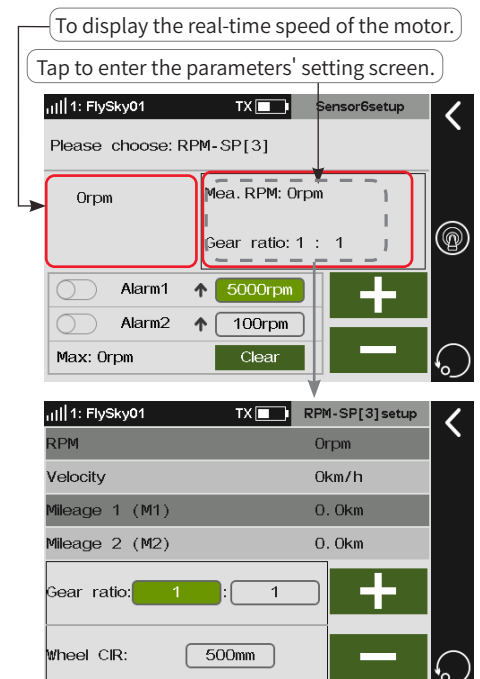

微信公众号



Bilibili



Website



Facebook

The interface of the **Speed-SP** is shown on the right. For the setting of **Alarm** and **extreme value**, refer to the related setting of the **TX voltage**. For other setting of **Speed**, follow the steps below:

Function setup:

1. To reset **M**(mileage)**1** or **M2** by Taping **Reset M1** or **Reset M2**.
2. You can also set a switch to reset **M1** or **M2**. Click  to set the appropriate switch.

Note: The system calculates the speed based on the wheel circumference and the monitored rotational speed, and then calculates the mileage based on time. Therefore, the setting values of the gear ratio and circumference will affect the speed and mileage.

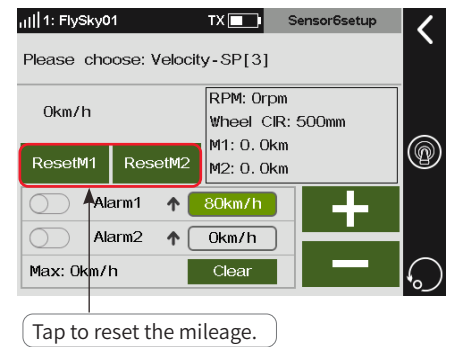

FS-CPD02: Optical Induction Speed Acquisition Module

Be used to measure the speed of the motor by light sensor. Monitor the real-time data of detection.

Installation steps:

1. Mount the sensor and the reflective sticker to the axial rotation position.

Note: Keep the reflective sticker flat and perpendicular to the sensor, and the distance between the sensor and the sticker is moderate.

2. Connect the FS-CPD02 sensor to the **SENS** interface of the FTr10 receiver.
3. Turn on the transmitter and enter **Home1 > Basic > Sensor**, then turn the rotating element, if the **RPM-SP** value changes, then the installation is successful, otherwise repeat the above steps.

The function setting of FS-CPD02, refer to related setting of FS-CPD01. Please notice when you set the gear ration, if you want to detect the propellers, the gear ratio is the ratio of 1 to the number of propellers.

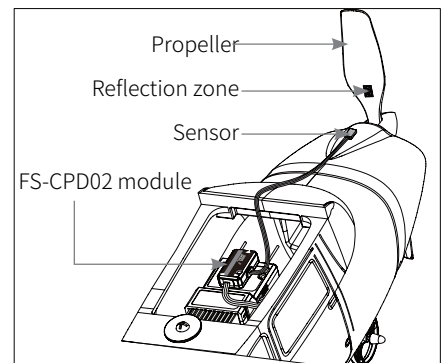

FS-CTM01: Temperature Acquisition Module

This sensor is used to monitor the temperature of a chosen part of the model.

Installation steps:

1. Use soft double-sided tape to attach the FS-CTM01 sensor to the object you want to measure (e.g., motor, battery). Make sure the sensor is pressed against the surface snugly for the best readings.
2. Connect the FS-CTM01 sensor to the **SENS** interface of the FTr10 receiver.
3. Turn on the transmitter and enter **Home1 > Basic > Sensor**, if the **Temperature** displays, it indicates that the installation is successful, otherwise repeat the above steps.

Note: **Temperature** means the sensor is testing the temperature; 26.4° C is the measured value.

The function setting of FS-CTM01, refer to related setting of FS-CPD01.



FS-CVT01 Voltage Acquisition Module

The FS-CVT01 function is used to monitor the model battery voltage.

Installation steps:

1. Turn on the transmitter and enter **Home1 > Basic > Sensor**. If the sensor displays External Voltage data, then installation is complete. Otherwise repeat the above steps.
2. Connect the FS-CVT01 sensor to the **SENS** interface of the FTr10 receiver.
3. Insert the red and black wire pins into the port on the battery. Red is positive and black is negative.

Note: **Ext voltage** means the sensor is testing the voltage; **3.2V** is the measured voltage value.

The function setting of FS-CVT01, refer to descriptions above.

FS-CAT01 Altitude Pressure Sensor

To detect the altitude of the model.



Installation steps:

1. Connect the FS-CAT01 sensor to the **SENS** interface of the FTr10 receiver.
2. Use double sided soft tape to snugly fix the FS-CAT01 sensor in place.
3. Turn on the transmitter and enter **Home1 > Basic > Sensor**. If the sensor displays **Height-PR** data, then installation is complete. Otherwise repeat the above steps.

Note: **Height-PR** means the sensor is testing the altitude; **14m** is the actual measured height value.

The interface of the **Height-PR** is shown at the right. For the **Alarm** and **extreme value**, refer to the related setting of the **TX voltage**. For the setting of **Height**, follow the steps below:

Function setup:

1. Tap **Hg zero** to clear the value of altitude or set a switch to clear it.
2. Tap  to turn on/off the prompt voice. Or set a switch to turn on/off the prompt voice, click  to return to the previous interface.

Notes:

1. The altitude sensor collects the changes in the barometric pressure to determine the altitude. Airflow changes can cause some errors in monitoring.
2. When the volume of the beep is higher, it means the aircraft is ascending, and when the volume is lower, it means the aircraft is descending.

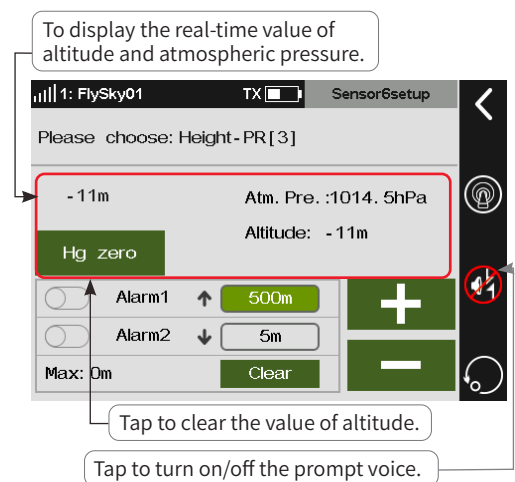

微信公众号



Bilibili



Website



Facebook

7.10 Timers

Note: This function is available for version 1.0.49 or later.

This function allows you to set various timers, which are generally used to calculate the total model running time, competition specific time spent or transmitter running time, etc.

7.10.1 Timer 1/2

Timers 1 and **Timers 2** have the same function. Only one timer setting method is introduced below.

Function setup:

1. Tap **Timer 1**.
2. Tap **Up** to switch the timer type.
3. Tap the function box next to **M** or **S**, + or - appear, click + / - to adjust the value to the desired point.
4. Tap **Sound** to scroll through the reminder mode.
5. Click and set the switches for **Start switch**, **Stop switch** or **Reset switch**. You can start, stop or reset the timer by the switches. Then click to return to the previous interface.

Notes:

1. The timer start/stop switch is an action switch. If the stop switch is not assigned, the start switch is the timer stop switch in the period from its start to end. If two timers need to start at the same time and stop at different times, you can assign different stop switches to them. You can also switch the start/stop by clicking the display timer area of the interface. This function is very useful for electric glider competitions.
2. When Timer 1 or Timer 2 is set to remind, the system will send out a reminder when it reaches a minute sharp. It will also send out a countdown reminder 30 seconds before the end of this time.

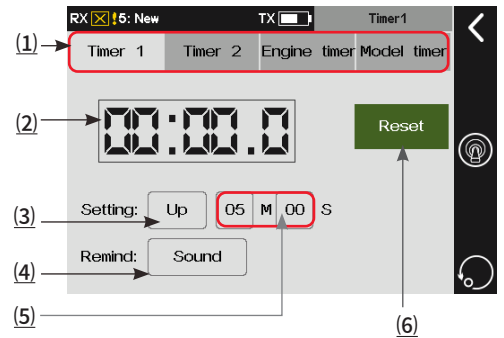

- (1) Tap to select the timer.
- (2) Display the current time. Click repeatedly to toggle the start/stop timer.
- (3) Tap to select the timing method.
- (4) Tap to select the reminder mode.
- (5) Tap the box next to **M**(minute) or **S**(second). + / - appear. Then click + / - to set the appropriate time.
- (6) Tap to reset the time during the timing process.

7.10.2 Engine Timer

To calculate total working time of the model.

Function setup:

1. Tap **Engine timer**.
2. Click + / - to set an appropriate trigger value.
3. Tap **Reset** to reset accumulated time. If the throttle exceeds the set value and when this function is activated. The timer will start. Then click to return to the previous interface.

Note: You need to activate this function manually as it is off by default.

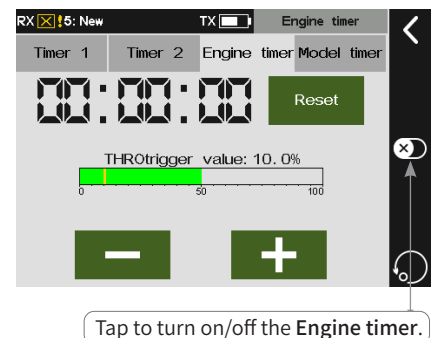

7.10.3 Model Timer

Turn on the timer by setting the throttle trigger value and calculate the operating time of the throttle after the trigger value.

Function setup:

1. Tap **Model timer**,
2. Click to activate this function, then click to disable the function.
3. Tap **Reset**, then click **Yes** on the pop-up interface to reset the accumulated time. Then click to return to the previous interface.

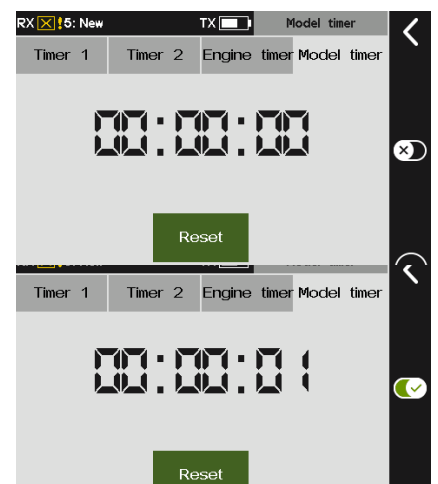

7.11 RF Setting

Set and display RF-related parameters/data, e.g., enable/disable RF function, type of RF, RF module firmware upgrade, RF module related information, etc.

7.11.1 Transmit

To enable or disable transmit function. If you don't need the transmit function, e.g., the transmitter works as a USB simulator, you can disable the transmit function by this function.

Function setup:

Click the check box next to the **Transmit**. "√" means the function is activated.

Note: For safety, the RF function cannot be disabled if the receiver is turned on.



7.11.2 RF Set To Be On By Default

Used to set whether to enable transmit function when the transmitter is turned on. If the check box is not selected, the transmit function will not be enabled when the transmitter is turned on. If you need to use it, enable the transmit function via this interface.

Function setup:

Click the check box next to the **RF set to be on by default**. "√" means the function is activated.

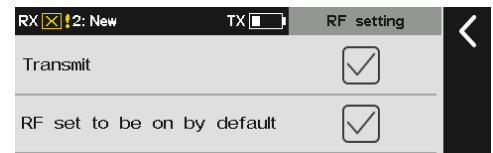

7.11.3 RF Type

Note: FRM303 and CRSF2 functions are added for version 1.0.70 or later.

Used to select an appropriate RF type as per the communication protocol of the receiver bound with the transmitter.

Both **FRM301** (compatible with classic version receiver) and **FRM303** (compatible with enhanced version receiver) adopt AFHDS 3 protocol; **PPM** is for RF module using PPM protocol, **CRSF** for RF module using CRSF protocol, and **CRSF2** type is for Black Sheep RF module which is compatible with CRSF2 protocol.

Function setup:

1. Click **RF type** to enter the setting interface.
2. Tap the appropriate RF type and click **Yes** on the pop-up interface to finish. Then click to return to the previous interface.

Note: When the RF type is set to CRSF2 and the receiver is normally connected, the RSSI parameters and the currently connected flight control parameters can be obtained, including voltage, current and battery capacity. And the returned data can be set to alarm through **Sensor > Sensor setup**.



微信公众号



Bilibili



Website



Facebook

7.11.4 FRM303 RF Module Note: This function is available for version 1.0.70 or later.

When the FRM303 RF module is used, you can use this function to set the RF type to FRM303. After setting, the RF buzzer alarm can be turned on or off in RF setting interface. After the buzzer is turned on, the alarm will sound in case of low signal and low voltage, as well as the temperature is too high or too low. In addition, three power versions are supported: non-adjustable Version, 25mW~1W version and 25mW~2W version.

Buzzer Alarm

To turn on/off buzzer alarm. The alarm function will be triggered when the RF module temperature is too high, or external power supply voltage is low, or the signal is low.

Function setup:

Tap Buzzer alarm. " ✓ " means the function is activated.

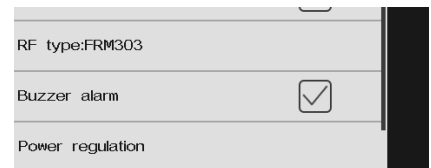

Power Regulation

The power adjustment interface varies with different adjustable versions. Note that the power supply mode of the FRM303 RF module also affects the actual output power. That is, if the power set exceeds the limit range, the maximum power within the limit range will be output. When the power is switched to a power other than 25mW, a popup prompt window will come along with it as shown.

Function setup:

1. Tap **Power Regulation**.
2. Tap an appropriate power item.

Note: The RF type is set to FRM303, the RF temperature and external RF voltage can be got. The obtained data can be set to alarm via **Sensor > Sensor setup**.

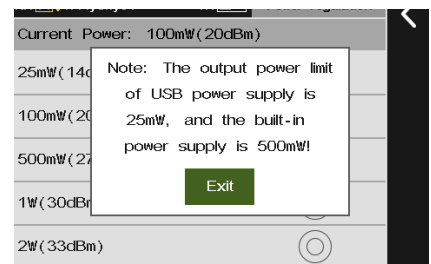
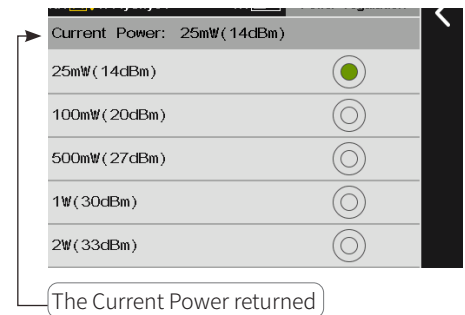

7.11.5 PPM Setting

When PPM is selected for RF type, a PPM setting function appears in the RF setting interface, where you can set the parameters related to PPM signals.

Signal polarity: By default (positive), high-level stands for valid signal. Some devices may require low-level for valid signal. Set the signal polarity to negative, and low-level represents valid signal.

Number of channels: To set the number of channels in one PPM signal. By default, each PPM signal contains 8 channels. You can set the number of channels as required.

Period: The time consumed to send a PPM signal. The period



of standard 8-channel PPM signal is 20ms. For fewer channels, you can set shorter periods. As the required time to send a signal is shorter, the delay is reduced. In period setting, you shorten the time of idle periods only, not that of the effective signal. Therefore, setting a shorter period will not reduce the number of signal channels. When the number of channels increases, and the transmission time of effective signals exceeds the period, the system will minimize the idle periods when processing the signals, and the interface setting will not change accordingly.

Starting level: Identifies the start index time of PPM signals. The default value is 400 us. You can set an appropriate value from 100us to 700us as needed.

Function setup:

1. Tap **Signal polarity** to set the the signal polarity, "✓" means the signal is positive.
2. Tap **Number of channels**. Then click + / - to set an appropriate number of channels.
3. Click **Period**. Then click + / - to set an appropriate period value.
4. Tap **Starting level** and click + / - to set an appropriate value. Then click  to return to the previous interface.



- (1) Tap to switch the signal polarity.
- (2) Tap to select Number of channels.
- (3) Tap to select Period.
- (4) Tap to select Starting level.

7.11.6 RF firmware Updating

To upgrade the RF firmware . It is only available when the RF type is set to FRM301.

Function setup:

1. Tap **RF firmware**.
2. Click **Yes** on the pop-up interface to enter the updating state.

7.11.7 RF Version

To view related information about the RF module.

Function setup:

Click **RF version**, the related information is displayed.

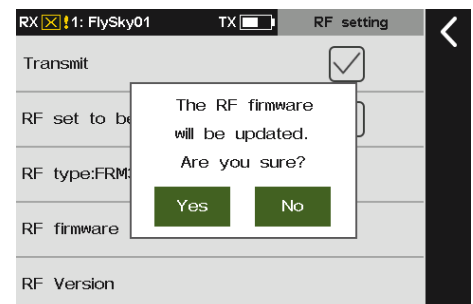

微信公众号



Bilibili



Website



Facebook

7.12 RX Setting

Information about receiver functions. It can be used to set various functions before the receiver is ready for work.

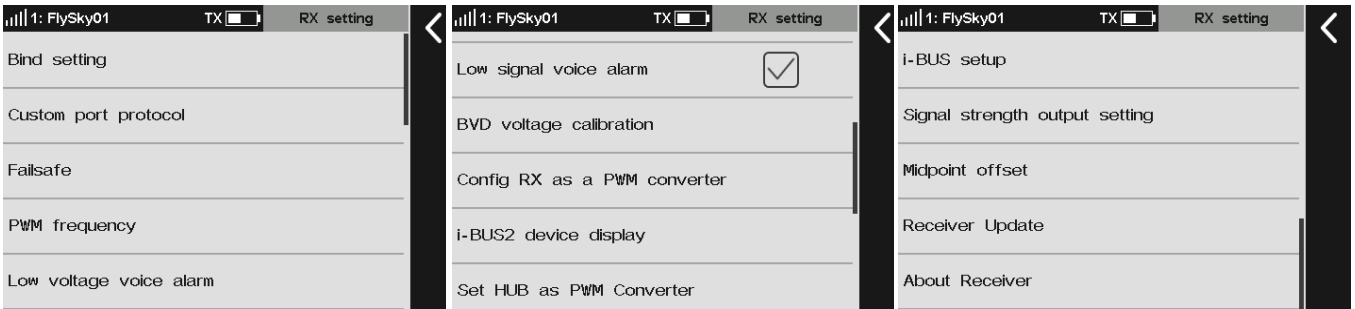

7.12.1 Bind Setting

This function is used to adjust the transmitter to the bind state and so as to bind with the receiver.

Refer to 5.2 Binding for detailed bind operations.

7.12.2 Custom Port Protocol Note: This function is available for version 1.0.45 or later. New items are added to this function for enhanced receivers.

Sets the type of output signal of the receiver interface. This screen shows on the left side the interfaces that can be set, and on the right side, the protocols that can be set. Only the enhanced receiver supports the output of i-BUS2 protocol signals.

Enhanced version receiver: When no receiver is connected, 4 Newport interfaces are displayed by default for setting; When a receiver is connected, the Newport interfaces that can be set on this receiver are displayed.

Classic version receiver: When no receiver is connected, i-BUS/Servo and CH1 are displayed by default; When a receiver is connected, the interface that can be set are displayed.

Function setup:

1. Tap **Custom port protocol** to enter the setting interface.
2. Tap the Newport you want to set, e.g. **NPA**. Then click the appropriate protocol.
3. Click to return to the previous interface.

Note: Neither classic version receiver nor enhanced version receiver supports i-BUS-IN setting in one-way communication. More notes are as below:

Enhanced version receiver:

- For double receivers, you can set the type of output signals for the interfaces of the primary and secondary receivers separately. However, the secondary receiver does not support external sensors. Therefore, the interface protocol cannot be set to i-BUS-IN.
- The signal types that can be selected once only in multiple for any Newport: PPM, S.BUS, i-BUS-IN and i-BUS-OUT. If it is selected for NPA, i-BUS-OUT cannot be selected again for NPD/NPC/NPB.

The screen of Custom port protocol is for enhanced RX.

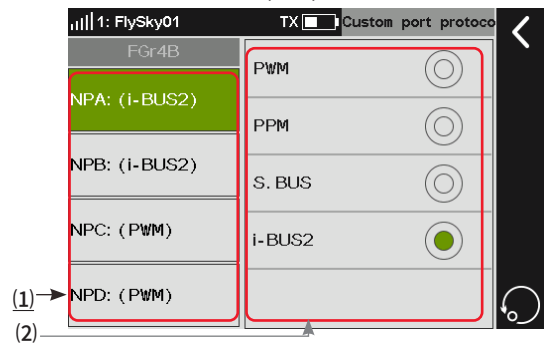

- (1) Tap to select the newport: NPA, NPB, NPC or NPD.
- (2) Tap to select the signal type for newport: PWM, PPM, S.NUS, i-BUS-IN, i-BUS-OUT or i-BUS2.

The interface of Custom port protocol is for classic RX.

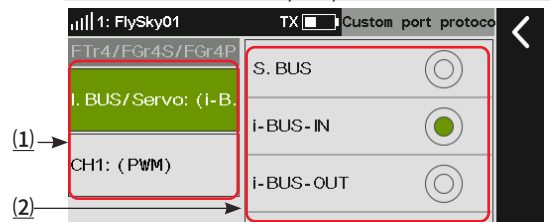

- (1) Tap to select i-BUS/Servo or CH1.
- (2) Tap to select the signal type for i-BUS/Servo or CH1.

The interface is for double receivers are bound.



- (1) Tap to enter the port protocol setting menu for primary RX.
- (2) Tap to the port protocol setting menu for secondary RX.



- If i-BUS is selected for any Newport, i-BUS2 cannot be selected for any other Newport; If i-BUS2 is selected for any Newport, i-BUS cannot be selected for any other Newport. For i-BUS2 and PWM options, Newport can select them repeatedly.
- If you have bound double receivers, you can set the interface protocol of the primary and secondary receivers separately.

Classic version receiver:

- For CH1, you can select PPM/PWM only. If the receiver does not support PPM signal output, the setting is invalid.
- For receivers with SENS interfaces, i-BUS/Servo does not support i-BUS-IN.

7.12.3 Failsafe Note: New failsafe test function is added for version 1.0.70 or later.

For failsafe, PL18 transmitter provides the following three settings:

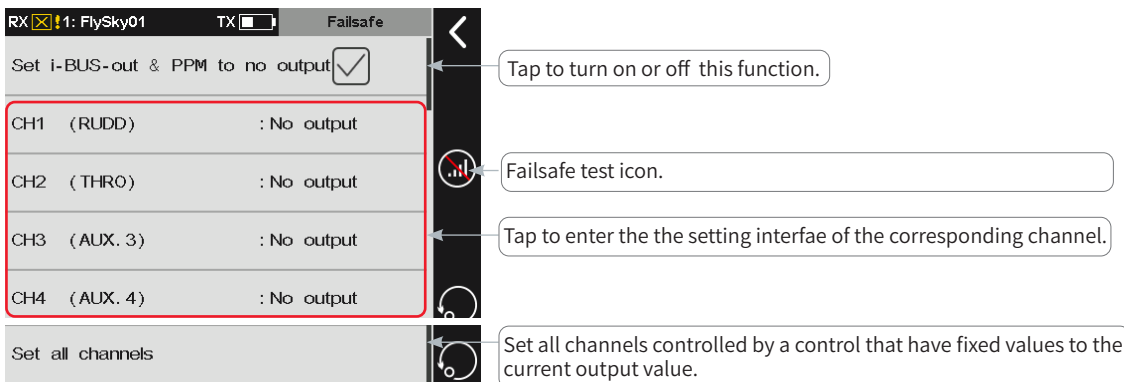

- Set to disable the signal output of i-BUS-out and PPM protocol interfaces in case of out-of-control, i.e., no output at i-BUS-out & PPM interfaces in case of losing control.
- Set failsafe values channel by channel: No output/Fixed value/Hold.
- New Added item: Set Failsafe for all channels set to fixed values. With this function, you can set the output values of all channels controlled by a control to the current value, and this value will be output when the system is losing control.



Failsafe Test Function

Used to simulate the out-of-control case, when the model is out-of-control, the transmitter will shut down the RF, then the model will enter the out-of-control state. All channels will output according to failsafe settings.

Function setup:

1. Tap , a popup window comes along with it as shown. Press and hold  over 1S, then the system turns off RF. And the receiver output channel value according to failsafe settings.
2. Release , the RF is on and the connection is restored.

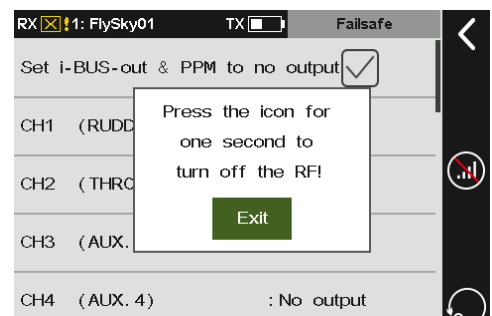

微信公众号



Bilibili



Website



Facebook

Set i-BUS-out & PPM to No Output

This function is for i-BUS and PPM signals. After the **Set i-BUS-out & PPM to no output** is enabled, regardless of the setting of the failsafe, these two types of failsafe signals are always no output. If the function is disabled, after losing control, you can set by channel: set to fixed value or keep the last output value. By default, this function is enabled.

Function setup:

If the check box next to right of the option is not ticked (✓), it indicates that the function is disabled.

Note: When Set i-BUS-OUT&PPM signal to no output is not checked and the channel is set to no output, the last value is output in case of out-of-control.

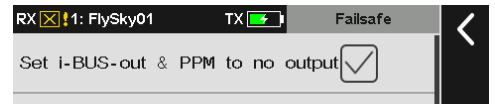

Channel 1~Channel 18

Can be used to set the output signal states of channels 1~18 respectively: **No output** means that there is no output in case of out-of-control; **Hold** means the last channel value is kept in case of out-of-control; **Fixed value** means that you can set the failsafe output value by moving the control, then the value set will output in case of out-of-control.

Function setup:

1. Tap to select the channel to be set and enter the next level interface.
2. Tap to select the desired function options. If the fixed value is selected, turn the **Stick**(Switch, Knob or LSW) to the desired position and hold it, then click  to return to finish the settings.

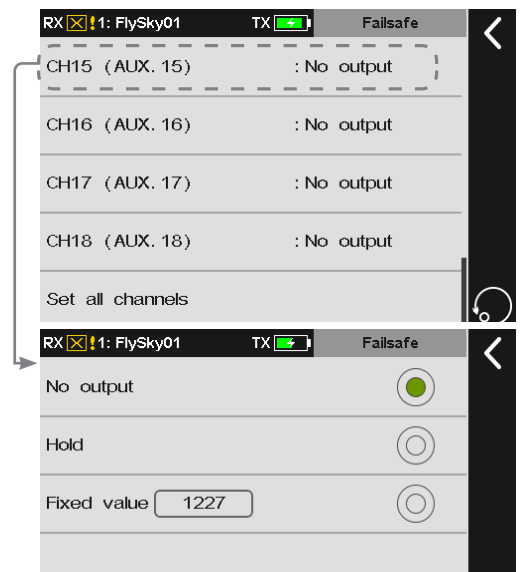

Set All Fixed Value Channels

Can be used to set the output value of all channels controlled by a control that has been set to a fixed value after out-of-control.

Function setup:

Tap this function while holding the control, after that a prompt interface comes along with it. Click **Yes** to complete.

Note: For the channels controlled by a control, please refer to FUNC. ASSGN section for detailed.

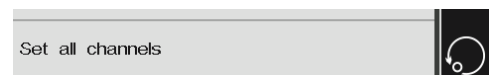

7.12.4 PWM Frequency Note: This function is available for version 1.0.65 or above. New items are added to this function for enhanced version receivers.

The receiver's output frequency of PWM signals can be regulated. Theoretically, the higher the frequency, the faster the signal is refreshed, and the faster the servo responds to the signal change. However, some servos may not support PWM signals with excessively high frequency. You may need to take into account the servo's performance when doing such settings.

The interface of this function may vary with bind modes. For enhanced receivers, the PWM frequency of each channel can be set separately, and the options include analog servo (50 Hz), Digital servo (333 Hz), SR (833 Hz), SFR (1000 Hz) and Custom.

If a classic receiver is bound, all channels are set together, and cannot be set to SR (833 Hz) and SFR (1000 Hz).

PWM Frequency-Enhanced Version Receiver

Sets PWM frequency after the transmitter is bound to enhanced version receivers.

Set All Channels

Sets PWM frequency for all channels.

Function setup:

1. Tap **Set all channels**.
2. Tap the appropriate item according to the actual servo. Then click  to return.
3. For **Custom**, click + / - to set an appropriate frequency value.
4. For **Synchronized with RF**, click the check box at the right. "√" means the function is activated.

Set A Channel

Sets PWM frequency for a channel.

Refer to the descriptions of **Set all channels** for function setup.

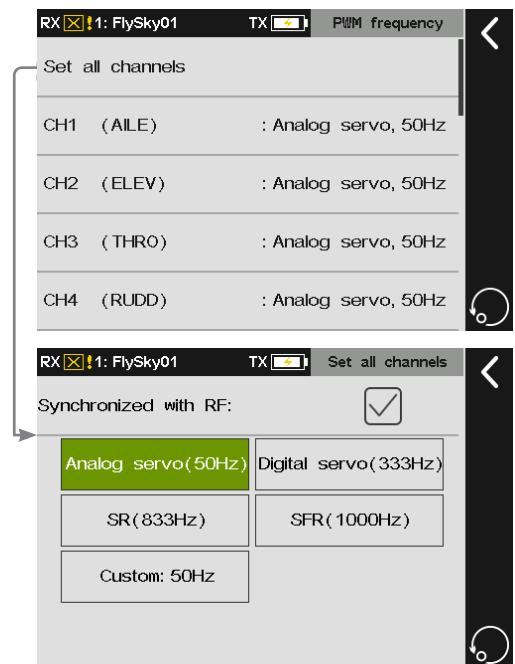

 ATTENTION	<ul style="list-style-type: none"> The conventional PWM frequency is 50-400 Hz. When SR (PWM frequency: 833 Hz) and SFR (PWM frequency: 1000 Hz) are selected, the overall system delay is greatly improved, but the pulse range of PWM signals is changed. Please make sure the servo supports the frequency and the setting is correct. Otherwise the servo may not work properly, or even get damaged.
--	--



微信公众号



Bilibili



Website



Facebook

PWM Frequency-Classic Version Receiver

Sets PWM frequency after the transmitter is bound to classic version receivers.

For the setting of PWM frequency, please refer to **Setting All Channels**.



7.12.5 Low Signal Voice Alarm

Enables or disables voice alarm of low signal.

Function setup:

Tap **Low signal voice alarm**. "√" means the function is activated.

With this function checked, the LED of the transmitter flashes and gives the voice alarm of **Low signal** when the RSSI of the receiver is lower than or equal to 40.

7.12.6 Low Voltage Voice Alarm

Set voltage alarm, battery type, low voltage alarm value and ultra-low voltage alarm value. Once it is set, the transmitter will trigger a voice alarm if the battery voltage of the relevant device is lower than the alarm voltage set to alert the user of low voltage or ultra-low voltage.

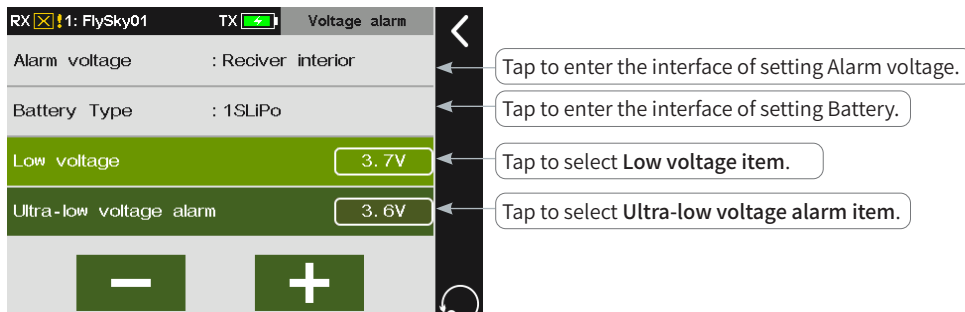

Function setup:

1. Click **Alarm voltage** to enter the next interface.
2. Tap the appropriate item according to you want to set. Then click to return.
3. Tap **Battery Type** to enter the setting interface, then click the appropriate battery type.
4. Click **+ / -** to set an appropriate voltage according to the actual device.

Notes:

1. Please refer to **14.1.3** for turning on or off the voice.
2. When it is set to detect the voltage of external sensors, and the receiver is connected to more than one voltage sensor, only the first voltage sensor connected to the receiver is detected for its voltage.
3. If **BVD voltage** is selected, the receiver needs a BVD interface to detect BVD voltage via BVD detection cable.
4. When double receivers are bound, the receiver voltage alarm is set to the primary receiver.

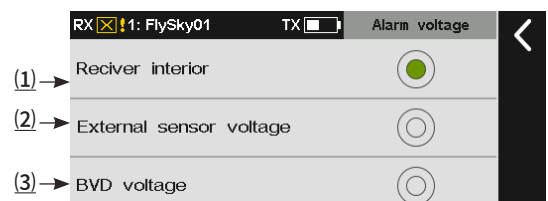

- (1) Tap to select **Receiver interior**, and to detect the receiver voltage. The alarm is triggered when the detected voltage value is equal to the alarm value.
- (2) Tap to select **External sensor voltage**, and to detect the voltage of the external sensor.
- (3) Tap to select **BVD voltage**, and to detect BVD voltage.

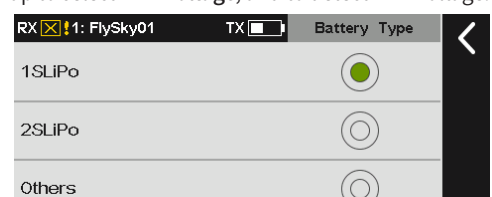

7.12.7 BVD voltage calibration

There may be a voltage difference between the receiver detection voltage and the actual battery voltage. This function provided the receiver with a calibration factor to narrow the gap between the detected and actual voltages. The calibration factor is stored in the receiver. Set the calibration factors separately when different receivers calibrate the same battery, or the same receiver calibrates different batteries.

Function setup:

1. Make sure the transmitter and receiver are bound; Connect the BVD harness to the receiver's BVD interface. Make sure the positive and negative terminals are connected to the positive and negative poles of the battery.
2. Tap **BVD Voltage Calibration** to enter calibration screen.
3. Click +/- to tune to the measured voltage of the battery.
4. Click **Calibrate** to calculate the calibration factor by the current value and the sensor measured value, and the result will be sent to the receiver to calibrate the BVD detection function.

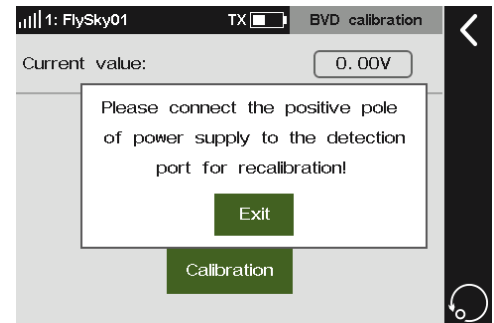

Notes:

1. This function is applicable to enhanced version receivers with BVD function.
2. This function calibrates the BVD voltage of primary receiver. To calibrate the secondary receiver (double receivers), you have to calibrate the BVD voltage of this secondary receiver-to-be before you bind it to the transmitter.
3. Make sure the battery is properly connected during calibration. To ensure accurate calibration, the Current Value, in calibration, needs to be set to the battery's measured voltage value. Recalibrate if necessary.

7.12.8 Config RX As A PWM Converter

Note: This function is not available for all receivers. For the classic receiver, only is available for the FG4 and FTr10 receivers.

For the classic version receivers, after it is set as a PWM converter, its SENS interface is connected to the interface of the receiver outputting i-BUS or i-BUS2.

For the enhanced version receiver, after it is set as a PWM converter, its NPA interface is connected to the interface of the receiver outputting i-BUS or i-BUS2.

The receiver set as the PWM converter can be converted into a receiver by rebinding the transmitter, and then used normally as a receiver after successfully rebinding the transmitter.

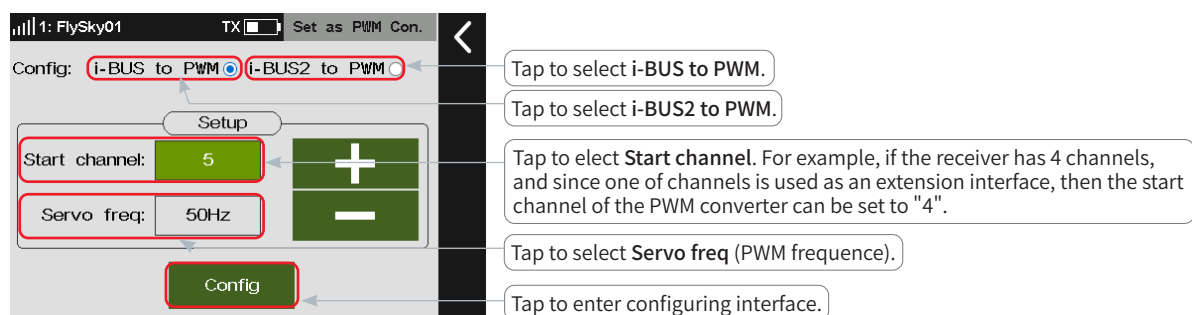

微信公众号



Bilibili



Website



Facebook

Function setup:

1. Enter the interface of **Config RX** as a **PWM converter**.
2. Tap **Start channel** or **Servo freq**, then click **+ / -** to set an appropriate value. Then click **Config**, the configuring interface comes along.
3. Put the receiver to enter the bind mode, after the LED status of the receiver changes from fast flash to slow flash, it indicates the configuration is finished. Then click **Return** to return.

If you set the receiver as a i-BUS2 PWM converter, there are not **Start channel** and **Servo freq** function items. After the receiver is set as a i-BUS2 PWM converter, you can set the related parameters via **i-BUS2-PWM Converter Setting** function

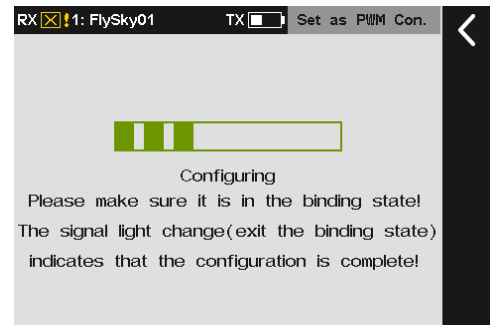

7.12.9 i-BUS2 Device Display Note: The i-BUS2 Sensor Preview is added for 1.0.70 or later.

To preview the i-BUS2 device detected by the transmitter to check whether each i-BUS2 device is connected properly. The displayed information varies with devices. For example,

- for the PWM converter, **Device List** displays the converter name, and **Device Information** displays the device name and the number of interfaces.
- For the HUB device, **Device List** displays the device name and the name of i-BUS2 device connected to the interface of the converter, and **Device Information** displays the device name and sensor ID.
- For the GPS device, **Device List** displays the device name, and **Device Information** displays the device name and sensor ID.
- For i-BUS2 sensor, **Device List** displays the interfaces and type, and **Device Information** displays the type and number of the sensors.

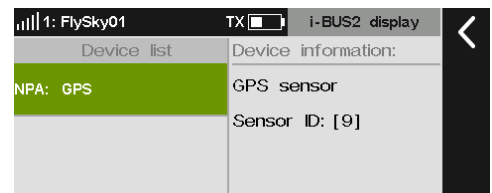
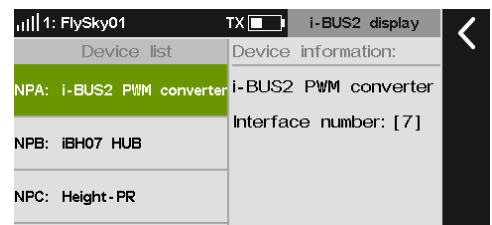

Function setup:

Tap **i-BUS2 device display** to view the related information.

Notes:

1. This screen displays only the i-BUS2 device identified by the transmitter. The i-BUS2 device shall be properly connected to the interface of which the receiver is set as i-BUS2 protocol.
2. The i-BUS2 signal only supports the secondary expansion.
 - When the receiver has only one interface set as i-BUS2 protocol, the i-BUS2 HUB output port connected to this interface can be connected to i-BUS2 HUB again. This HUB interface can still output i-BUS2 signal and can be connected to the i-BUS2 device.
 - When the receiver has two or more interfaces set as i-BUS2, the signal has been extended once by the receiver, so that i-BUS2 HUB output port accessed by the interface at this time can no longer be connected to the HUB, but can be connected to other i-BUS2 devices for use.

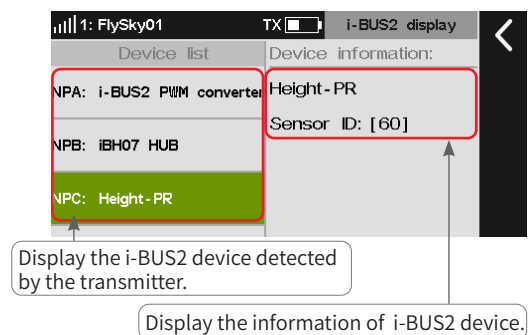

7.12.10 i-BUS2 RPM Sensor Note: This function is available for version 1.0.70 or later.

When the transmitter detects the i-BUS2 RPM sensor, the



interface is displayed. At this time, you can set the number of propellers of the i-BUS2 RPM sensor.

Function setup:

1. Tap **i-BUS2 RPM** to enter.
2. Click **+ / -** to set an appropriate value of propeller, Then click **↩** to return.

Note: It is can be set the number of propellers of the rotate speed sensor (1~12).

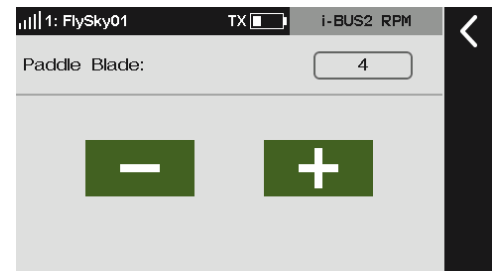

7.12.11 Set i-BUS2 HUB As A PWM Converter

When the transmitter detects the i-BUS2 HUB device, this setting interface is displayed. The i-BUS2 HUB device can be set as the PWM converter, and the same function as the receiver being set as PWM converter for use.

Note: This function is only available HUB FS-iBH07.

Function setup:

1. Tap **Set i-BUS2 HUB as a PWM converter** to enter.
2. Tap the device you want to set if there are more than one device, then click **Config** on the interface to finish.

Notes:

1. This function is only available when such i-BUS2 devices are connected. If only one such device is connected, the **Select equipment(Device)** screen is skipped.
2. i-BUS2 HUB device connects to any of the NPA~NPD interfaces of the enhanced receiver (custom interface protocol is set to i-BUS2) so as to establish a connection with the transmitter.
3. If the i-BUS2 device interface has already connected to another device, the i-BUS2 HUB disconnects with the devices previously connected after setting as a PWM converter.

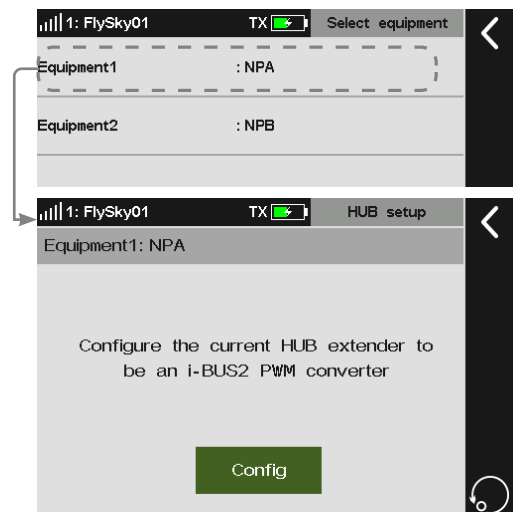

7.12.12 i-BUS2 PWM Converter Setting

Set the i-BUS2 protocol converter function. You can set the converter to HUB, PWM frequency of the converter interface, and the output signal channel of the converter interface.

Note: This function item is only available when such i-BUS2 devices are connected. If only one such device is connected, the Select Device screen is skipped.

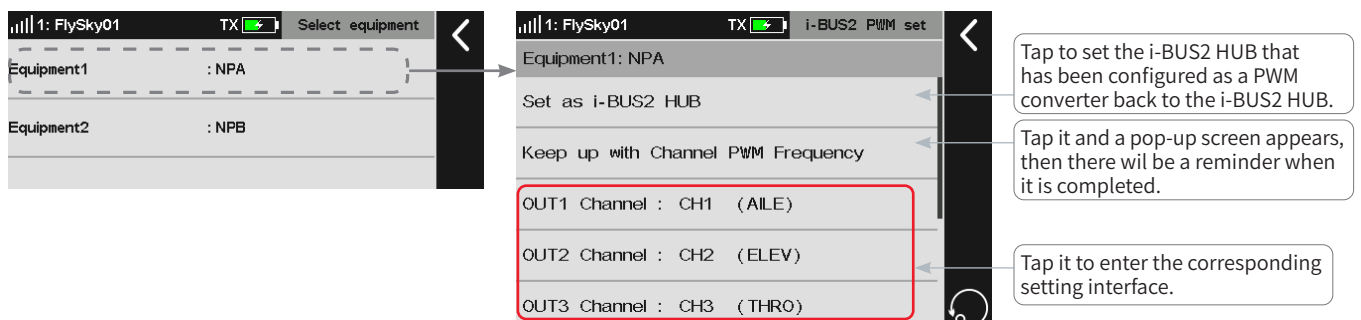

Set As i-BUS2 HUB

To set the i-BUS2 device that has been configured as a PWM converter back to the i-BUS2 HUB.



微信公众号



Bilibili



Website



Facebook

Function setup:

Tap **Set as i-BUS2 Device** to back to the i-BUS2 HUB.

Note: If the converter is configured for the receiver, it prompts setting failure. The receiver is not supported to be used as HUB.

Keep up With Channel PWM Frequency

To set the output PWM signal frequency of the converter interface.

Function setup:

Tap **Keep up the channel PWM frequency**. A pop-up screen appears, and there will be a reminder when it is completed.

Set The Channel of The Output

To set the channel of converter output interface.

Function setup:

1. Tap the channel you want to set.
2. Tap an appropriate item. Then click  to return.

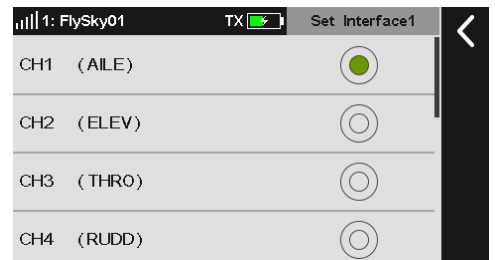

7.12.13 i-BUS2 GPS Sensor Setting

Note: This function is available for version 1.0.65 or above.

This function is applicable to GPS module of i-BUS2 protocol. Through this function, you can set the standard time zone, perform gyroscope level calibration, and view GPS parameter display interface to get relevant information.

Note: This function is only available when such i-BUS2 devices are connected. If only one such device is connected, the Select Device screen will be skipped.

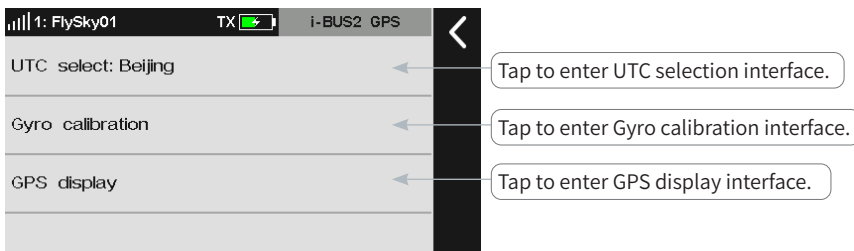

UTC Selecting

To set UTC.

Function setup:

1. Tap **UTC select** to enter.
2. Tap an appropriate time zone. Then click  to return.

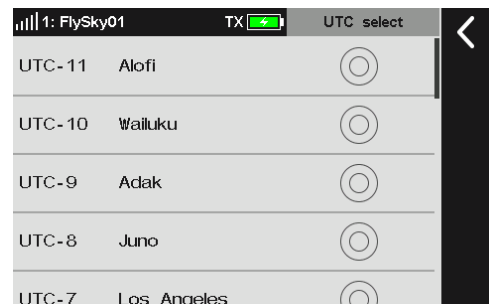

Gyroscope Calibration

Calibrate the gyroscope. Before calibration, please connect the GPS sensor to the device correctly and make sure the device is placed horizontally.

Function setup:

1. Tap **Gyro calibration** to enter.
2. Tap **Calibration**. The system will calibrate automatically.
3. When calibration succeeds or fails, the system displays a pop-up screen indicating the success or failure of calibration. Click **Exit** on the prompt screen to return to the previous screen.



GPS Display

To display the information returned by the GPS sensor.

Function setup:

Tap **GPS display** to enter, then you can view the related information. Click to return.

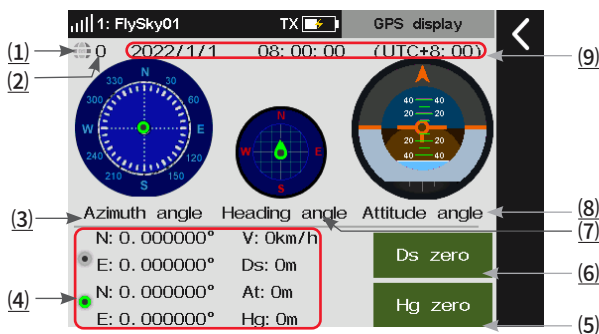

(1) To show whether the positioning is successful or not. If the icon is blue indicating the positioning is successful, the icon is gray, then the positioning is failure.

(2) To display the quantity of satellites.

(3) Azimuth angle: Refers to the orientation of the aircraft from the zeroing point. The green dot that moves on the dial marks the current orientation of the aircraft from the starting point. The center of the azimuth angle indicates the starting point. By default, the starting point is the power-on position.

(4) The information of latitude and longitude, distance, height, altitude and speed is displayed. Above is latitude and longitude of a position point when the distance is zeroed, and below is the real-time latitude and longitude of a position where the aircraft is in. Speed refers to the speed of the aircraft relative to the ground. Height refers to the height of the aircraft relative to the ground. Distance refers to the distance of the current position of the aircraft relative to the starting position.

(5) Hg zero: Tap to clear the height value.

(6) DS zero: Tap to clear the distance value.

(7) Heading angle: Used to indicate the real time heading angle of the aircraft during the flight.

(8) Attitude angle: The center of the circle moves up and down to indicate the pitch angle of aircraft. Outer circle rotates to indicate the roll angle of aircraft.

(9) To display the date, time and time zone. The date is showed by Year/Month/Day, and the time is showed in 24-Hour clock format.



微信公众号



Bilibili



Website



Facebook

7.12.14 i-BUS Setting

This function is used to set the external device with supporting i-BUS protocol, and the Serial Bus Receiver and Voltage sensor can be compatible with it currently.

Serial Bus Receiver FS-CEV04 Setting

After the setting is completed, FS-CEV04 can convert i-BUS signal to PWM signal and output PWM signal.

Function setup:

1. Make sure the transmitter and the receiver are bound.
2. Connect the FS-CEV04 to the SERVO port on the receiver.
3. Connect a servo to one of the C1-C4 ports of the FS-CEV04.
4. Power on the transmitter and navigate to the **i-BUS setup** function item located in the **RX setting** function. Select the channel you want to assign. if clicking a wrong channel, then click **Cancel** to cancel it.
5. Press the corresponding button. After the channel assignment is successful, a pop-up window will appear.
 - If the channel assignment is successful, channel number and interface number will be displayed.
6. Repeat the steps above for setting more channels.
 - If there are too many peripherals attached to the i-BUS serial bus receiver, power it separately.

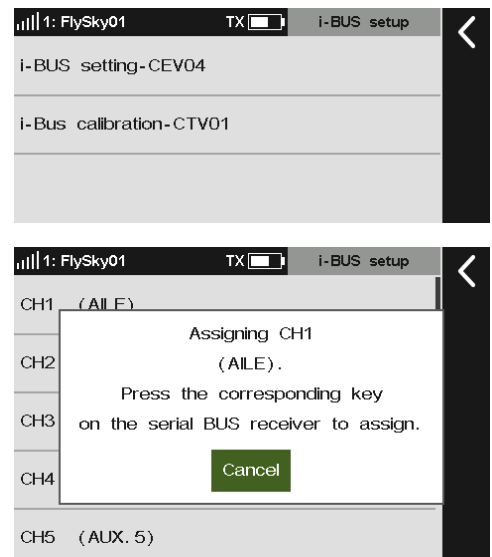

FS-CVT01 Voltage Sensor Calibrating

Note: This function is available for version 1.0.65 or above.

A calibration factor can be set to correct the voltage value returned by the i-BUS voltage sensor FS-CVT01. The calibration factor is stored in the transmitter and shall be recalibrated when the battery type is changed.

Refer to 7.9 Sensor FS-CVT01 for the description of function setup.

Note: During the calibration, the voltage sensor must be connected to a power supply.

7.12.15 Signal Strength Output Setting

Through this function, you can select a channel to output the signal strength value of the receiver. After the function is enabled, the selected channel does not perform the output of transmitter's corresponding channel function, but outputs the receiver's signal strength value. This function is necessary for users who use FPV glasses in the operations of traversers. We recommend you to select the CH14 or any auxiliary channel. You can make corresponding adaptations in the flight control settings to view the signal strength information on FPV glasses.

Function setup:

1. Tap **Select output channel**.
2. Tap an appropriate channel. And it will automatically return.

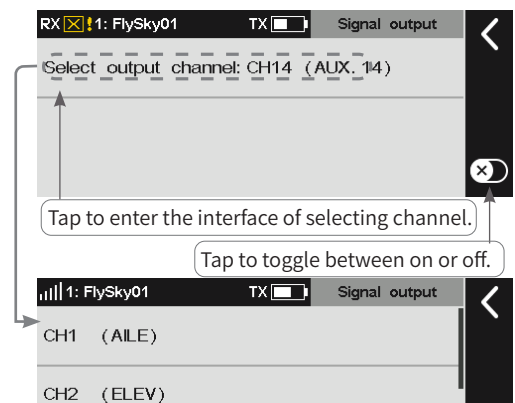

7.12.16 Midpoint Offset

This is designed for some servos with a midpoint value identified as 1520. Usually, the transmitter assigns the channel midpoint value of 1500 to the receiver. After the selection of offset, the receiver will output the channel value to the servo by superimposing 20. When you use standard S.BUS protocol devices such as Vbar gyroscope flight control, this function can be set as Offset to achieve the midpoint offset for all channels.

Function setup:

1. Tap **Midpoint offset**.
2. Tap an appropriate channel. Click  to return.



7.12.17 Receiver Update

To update the firmware of the receiver. PL18 transmitter packs the firmware of FTr10, FTr16s and etc.. The packed firmware varies with different version firmware. If the receiver does not adapt the transmitter or unexpected error occurs, then upgrade the receiver's firmware. It can also be updated via FlyskyAssistant. Please note that this function is applicable for the FlyskyAssistant firmware version 3.0 or later, and meanwhile, the transmitter with firmware version is 1.0.55 or later.

Function setup:

1. The transmitter and the receiver has bound normally.
2. Tap **Receiver Update** to enter and select the receiver you want to update.
3. Click **Update**, then click **Yes** in the pop-up window to put the receiver into updating mode.
4. After the updating is completed, it is will automatically return the previous interface.

Note: If the receiver firmware is the latest version, the system will display a propted reminder and no need to update.

 ATTENTION	<ul style="list-style-type: none"> • If the transmitter is unable to bind with the receiver after its firmware is updated, it is required to forced update the firmware of the receiver.
--	---

To put the receiver into forced updating mode first, then follow the steps above to update.

The methods of entering forced mode varied with the models, refer to the manual of the receiver for the datailed.

Take FTr10 receiver as an example to show how put it into forced updating mode. Connect the bind cable to the signal pin of the **BIND** and the other signal pin shown in the picture, then power on the receiver.

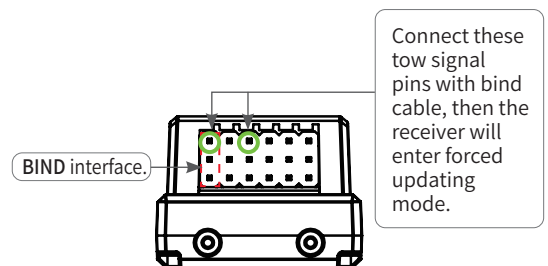

7.12.18 About Receiver

To view the information of the receiver connected.

Function setup:

Tap **About receiver** and view the information.

Note: If the double receivers are connected to the transmitter, the information on Primary receiver is displayed.



微信公众号



Bilibili



Website



Facebook

7.13 Trainer Mode Note: This function is applicable for version 1.0.65 or later.

PL18 transmitter supports two function modes: **Trainer** and **Student**. The transmitter set as trainer mode receives the external signal control model, namely the trainer port has the ability to recognize the external PPM signal input as well as the normally connected wireless trainer unit. The transmitter set as student mode only outputs the PPM signal rather than input signal or connected wireless trainer unit. Two transmitters (one in trainer mode and the other in student mode) can be connected through the trainer cable or the wireless trainer. The transmitter set as student mode only outputs the PPM signal rather than input signal or connected wireless trainer unit. The two connection methods can be used simultaneously.

Notes:

1. Please verify that the servo surface feedback and motor feedback are normal on the ground before flight.
2. If the two transmitters are connected through the trainer cable, please make sure that the trainer cable is connected correctly. If the two transmitters are connected through the wireless trainer unit, please make sure that the wireless trainer unit is connected correctly in normal communication.
3. The PL18 transmitter's trainer port can be adaptive to recognize the input PPM signal. Most of the devices supporting PPM output can be used as the external input signal source of trainer mode. However, some devices may not support this function. The PPM output of the trainer port can be set to match external devices with special PPM signal recognition requirements.

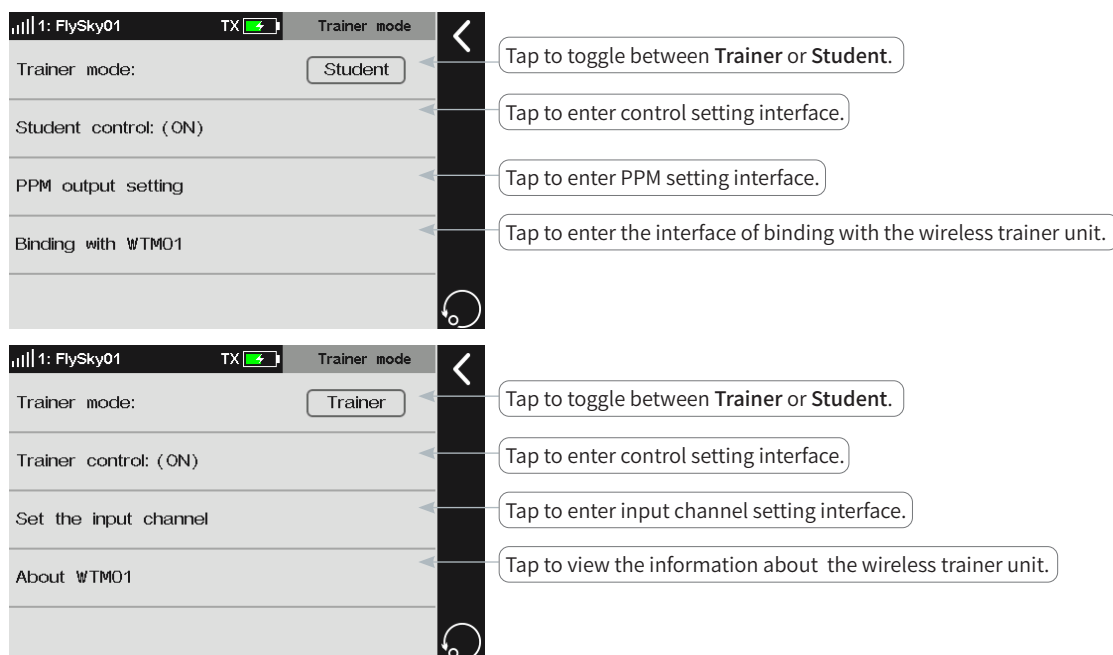

7.13.1 Student Mode

When the trainer mode is set as student, the transmitter supports only functions of student mode at this time. Now trainer function applications can be realized through matching with trainer mode of transmitter by setting the student control switch, setting PPM output of trainer port, and binding wireless trainer function.

Trainer Mode

To switch between the **Trainer mode** and the **Student mode**.

Function setup:

Click **Trainer Mode** repeatedly to switch between **Tainer** or **Student**.

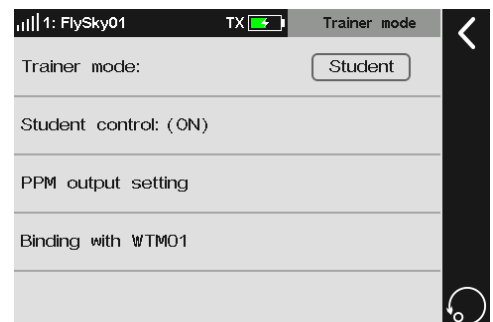

Student Control

Perform the switching to indicate whether the student accepts the control or not. Normally, this switch state is effective when **Trainer control** of trainer mode is disabled.

Function setup:

Click **Student control** to enter the switch assignment menu and set the appropriate button. Refer to Chapter 16 in this manual.

Note: Under normal circumstances, make sure that the student control switch is enabled. In this case, the student signal can be sent to the trainer transmitter. Usually, the switch can be set to "--" and normally ON. Please refer to chapter 16 for the switch setting. When the trainer uses the student mode to remotely assist the student to practice, the control authority can only be switched through this switch if the control authority needs to be switched. For details of application scenarios, see the later section.

PPM Output Setting

Set the type of PPM signal output from the trainer port, such as **signal polarity, Number of channels, Period and Starting level.**

Refer to **RF setting** section for the description of function setup.

Binding With FS-WTM01

Bind the transmitter with the wireless trainer module.

Function setup:

1. Tap **Binding with WTM01** to enter the binding screen, then put the transmitter into binding mode.
2. Power on the wireless trainer unit and put it into binding mode. The LED of the wireless trainer unit is solid on after the binding is successful.

Notes:

1. After the model is switched, the wireless trainer unit shall be rebound. The receiver bound in the previous model shall be rebound next time.
2. In the binding, make sure that the working mode of wireless trainer module is matched. For details, see the manual.

7.13.2 Trainer Mode

When the trainer mode is set as trainer, it means that the transmitter only supports the functions of trainer mode. At this time, you can set the matched student mode of transmitter through the trainer control switch and input channel to realize the application of trainer transmitter function.

Trainer Mode

Switching between trainer mode and student mode. By default, it sets to student mode.

Function setup:

Click **Trainer Mode** to switch between **Tainer** and **Student**.



微信公众号



Bilibili



Website



Facebook

Trainer Control

The trainer control switch must be **OFF** before the external signals can be used to control the model.

Note: Under normal circumstances, the trainer uses the trainer mode to teach remotely. If you want to use the student mode to teach remotely, the trainer mode control switch must be OFF.

Function setup:

Tap **Trainer control** to enter the switch assignment menu and set the appropriate button. Refer to Chapter 16 in this manual.

Set The Input Channel

To assign the functions of the control models corresponding to channel signals of the student transmitter.

Function setup:

1. Tap input **CH1-CH18** channels to enter the corresponding setting screen.
2. Tap **Control object** to enter the control object setting screen.
 - Tap **Stick or Knob** to enter the control object setting screen and select the appropriate stick or knob.
 - Tap **Basic Function** to enter the setting screen, and select the appropriate function item. This item is only available for aircraft models.
 - Tap **Output Channel** to enter the setting screen. Select the appropriate function item.
3. Tap **Mix mode** to enter the setting screen. Select **Normal** or **Mixed**.

Normal means the student transmitter will control the aircraft model completely. **Mixed** means that the signals of student transmitter and trainer transmitter are superimposed and output. Note that controls are in the neutral positions for the transmitter which is not involved in control.

Notes:

1. If the stick/knob is selected as the control object, the external input signal will be applied as the stick /knob volume for the function of controlling channel change. For example, when Stick/Knob is set to J3, the student mode of transmitter can control the corresponding function if J3 is functionally assigned with throttle for the trainer mode of transmitter, or J3 is assigned as a control in the **Butterfly fly** function.
2. If the control object is assigned as a function, the external input volume can be brought into the operation as the function master control quantity.
3. If the control object is assigned as a channel, the external input signal is used as the channel volume. At this time, the mix control function and trimming function of the trainer mode of transmitter will be invalid.

About FS-WTM01

Used to view the information of the wireless trainer unit which is connected with the transmitter.

Function setup:

Click **About WTM01** to view the information.

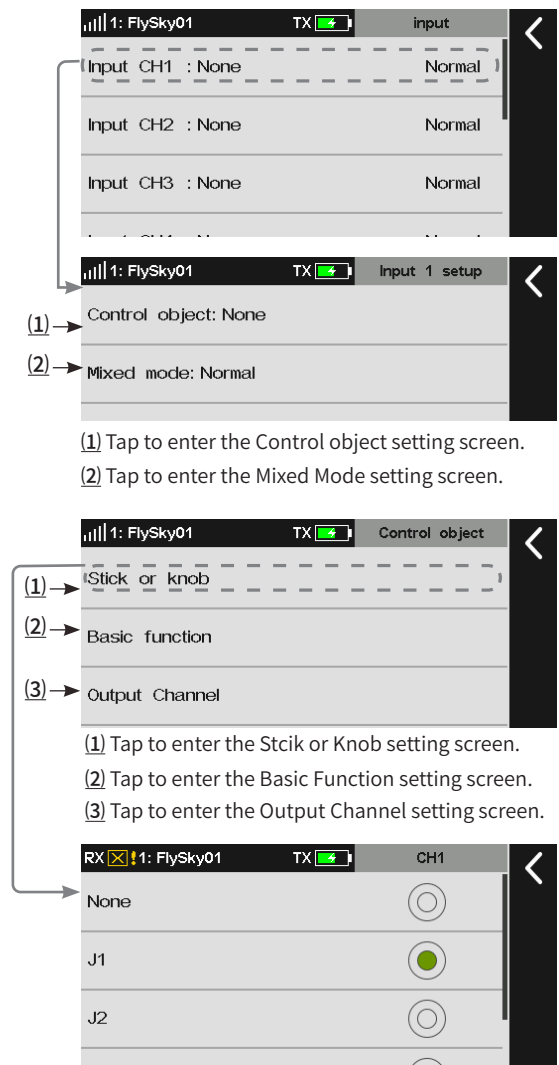

Description of trainer coaching

1. This transmitter can be set to student mode. At this time, when a switch can be assigned to control whether the student control signal is sent to the trainer mode of transmitter, and the trainer mode of transmitter can automatically switch to trainer control according to the abnormality (loss) of the student remote control signal.
2. According to the above principles, when the trainer coaching is needed in the training, students can set their transmitters as trainer mode and assign the corresponding channels of trainer control signals. The trainer control switch is kept normally **OFF**. The trainer sets his own transmitter as student mode and meanwhile assigns a student control switch.
3. During use, the trainer sets the student control switch to OFF by toggle switch. At this time, the student can concentrate on practicing with his own aircraft, and the trainer can observe aside and switch to take over the control when he confirms that the student needs help.

Note: This mode is applicable to only PL18 transmitter with firmware version 1.0.65 or later.



微信公众号



Bilibili



Website



Facebook

8. Airplane/Glider Exclusive Function Setting

This chapter introduces the function settings of Airplane/Glider mainly in default condition. After you can set the related model parameters via **Basic > Models**, then you can access **Model** to set the related functions of model via **Home1 > Model**.

Note: the function interface may different based on different model configurations.



8.1 Display Servos

Please refer to **7.1 Display Servos** for this function.

8.2 Condition

Note: This function is updated for version 1.0.70 or later.

You can set the condition selection mode. If you need to achieve different control effects through the switch or stick position, you can set this function. If you do not need to set this function, the transmitter will work in the default condition 1. Users can add a new condition in duplicate as needed. The system supports 5 conditions, and in addition to the default condition, all other conditions need to be assigned with a control (switch/stick, etc.). Conditions are switched through the control. The later ones have higher priority. The default condition will take effect when all the newly created conditions are off. The current condition can be determined by viewing the condition icon displayed on the main interface or the interfaces related to condition settings.

Note: Different parameters can be set for multiple functions of this transmitter by switching different conditions, to perform control operations in different conditions according to different setting parameters. The details are as follows:

1. For Func. assign, different assignments of control and trim can be set for different conditions, or the same for all conditions.
2. For digital trim (TR1~TR8) of Trim, different trim values can be set for different conditions or the same for all conditions.
3. For DR setting, the effective condition can be selected (multiple choices). The DR effectiveness of switching in different conditions may be different.
4. Other items related to the condition can be set separately by switching different conditions, and the channel operation can be executed according to this condition. Usually, the serial numbers and names of the current condition are displayed at the top of these function interfaces. These setting items are contained in the following function interfaces: Func. assign, Channel offset, Pro.Mixes, Servo speed, Throttle curve, Aileron, Flap, Airbrake, Elevator, Spoiler, Butterfly, V Tail, Pitch curve, Thro mixed, Swashplate ring, Hover adjust, Gyroscrop, Governor.

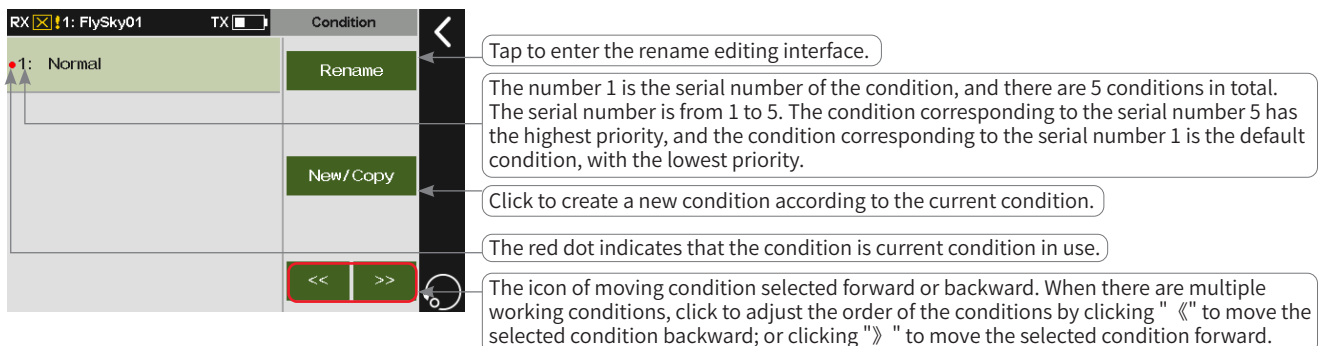

8.2.1 Rename

To rename the condition selected.

Function setup:

Tap **Rename** to enter editing interface.

Tap the characters that you want to use, afterwards click **Enter** to confirm. The system supports up to ten characters. Then click **Return** to return.



微信公众号



Bilibili



Website



Facebook

8.2.2 Set Switch

To set a switch to switch among the conditions.

Function setup:

Tap **Set switch** to enter switch setting interface.

Tap the related switch and the status. Then click  to return.

Note: The control switch, such as SWA, can also be selected by toggling the corresponding control on the transmitter.

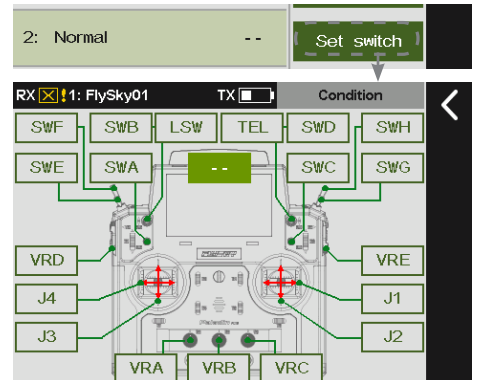

8.2.3 Creating/Copying A Condition

To create a new condition.

Function setup:

Tap **New/Copy** and a pop-up screen comes along with it. Click **Yes** to complete. Then click  to return.

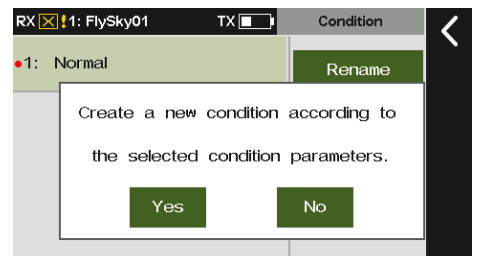

8.2.4 Deleting A Condition

To delete a condition selected.

Function setup:

1. Tap a condition you want to delete.
2. Click **Delete** and a pop-up screen comes along with it. Click **Yes** to complete. Then click  to return to the previous interface.

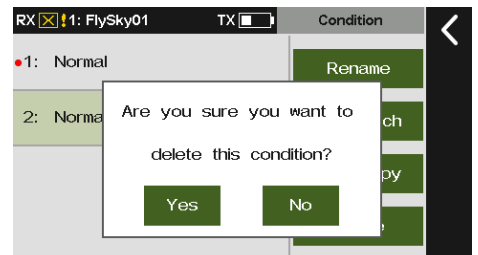

Note: If there is but one group of condition, you cannot delete it, namely there is no Delete function item.



8.2.5 Changing The Order Of The Conditions

Changes the order of the conditions so as to change the priority. The condition corresponding to the serial number 5 has the highest priority, and the number 4 is the next highest priority. The system works in this way according to this sequence.

Function setup:

1. Tap to select a condition.
2. Click  to move the condition selected forward. Click  to move the condition selected backward.

Notes:

1. Condition 1 is the default condition. It does not support settings of switch and change its order, i.e., the serial number of default condition is 1.
2. After the transmitter is turned on, the system will automatically judge whether the switch of condition 5 is on or off. If it is on, it will work in the condition 5 controlled by the switch. If it is not on, the system will judge whether the switch of condition 4 is on or off. If it is on, it will work in the condition 4 controlled by the switch. The system works in this way according to this sequence.

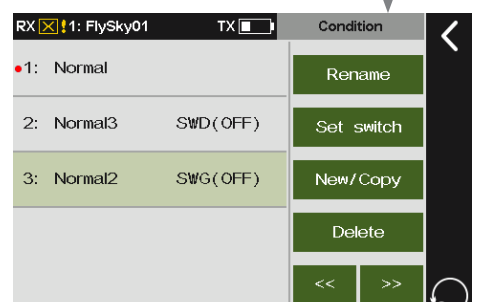
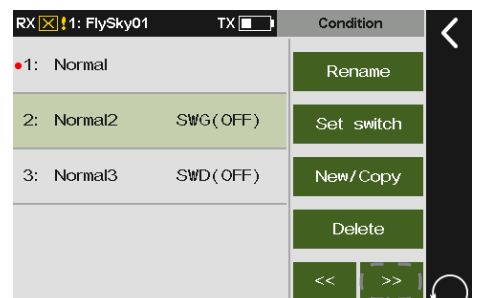

8.3 Func. Rate(AFR)

Note: This function is available for version 1.0.65 or later.

You can set servo volume change curves of all sticks, knobs, and switches assigned to the channel. You can switch to different conditions to set different curves respectively. The servo volume change curve for the conditions controlled by DR is set after enabling the DR. Those not supporting the assignment of the master control, such as Flap 2, cannot be set. The allocation of the same function of different channels from any setting entrance into the settings is the same. It is recommended that the **Func. rate** be set after the channel travel setting is completed. Any mixes source will be applied the **Func. rate** function.

Note: The function shown in grey cannot be selected.

Tap to enter the corresponding rate setting interface of each channel.

Display the real-time position of the control assigned to this function.

Display the real-time output rate of this function.

Tap repeatedly to toggle among the curve type.

Tap to select Rate A.

Tap to select Rate B.

Tap to enter interface of DR rate.

Tap to select EXPB.

Tap to select EXPA.

Tap to select Offset.

Note: RateA is the ratio to the left of the neutral, and vice versa for RateB. EXPA is the curve to the left of the neutral, and vice versa for EXPB. Rate A/B and EXPA/B are selected separately or fully depending on the curve type, when the curve type is EXP1, EXP1 can not be adjusted separately although it distinguishes between A and B. When the curve type is EXP2, SYMM (symmetric), the rate and curve are divided into A and B. A and B need to be set in linkage, and cannot be adjusted individually. When the curve type is EXP2, LINE, the rate and curve are divided into A and B, and both A and B can be adjusted separately.

Display the real-time rate and line type.

8.3.1 Setting Curve Type

Set the curve type.

Function setup:

Enter the rate setting interface. Tap **EXP, SYMM** repeatedly to toggle among the selections.

Please note that the data will be reset when the line type is changed.

8.3.2 Setting Rate/EXP/Offset

Set the related **Rate**, **EXP** and **Offset** after a line type has been set. Take Rate setting as an example.

Function setup:

1. Enter the rate setting interface and set to **EXP2, LINE**.
2. Tap **Rate A**, the item selected will turn to light green.
3. Click **+** or **-** to set a appropriate rate value.

For the setting of **EXP** and **Offset**, refer to the setting of **Rate**.



微信公众号



Bilibili



Website





Facebook

8.4 DR Setting

Note: This function is available for version 1.0.65 or later.

Set the function, switch of DR and effective condition to enable the DR.

Function setup:

1. Access DR setting interface, tap a function box corresponding to a DR to enter.
2. Tap a appropriate function, then click  to return to the previous interface.
3. Tap the function box corresponding to the DR below the **Switch** and set a switch to the function. Then click  to return to the previous interface.
4. Tap the function box below the **Mode**, tap the mode which activate DR mode. Then click  to return to the previous interface.

Notes:

1. When all 5 conditions in the transmitter are selected, **All** is displayed.
2. If some conditions are selected, the serial number of the selected condition is displayed.
3. If there is no condition selected, **Disabled** is displayed.
4. The function of linkage control does not support settings of DR.

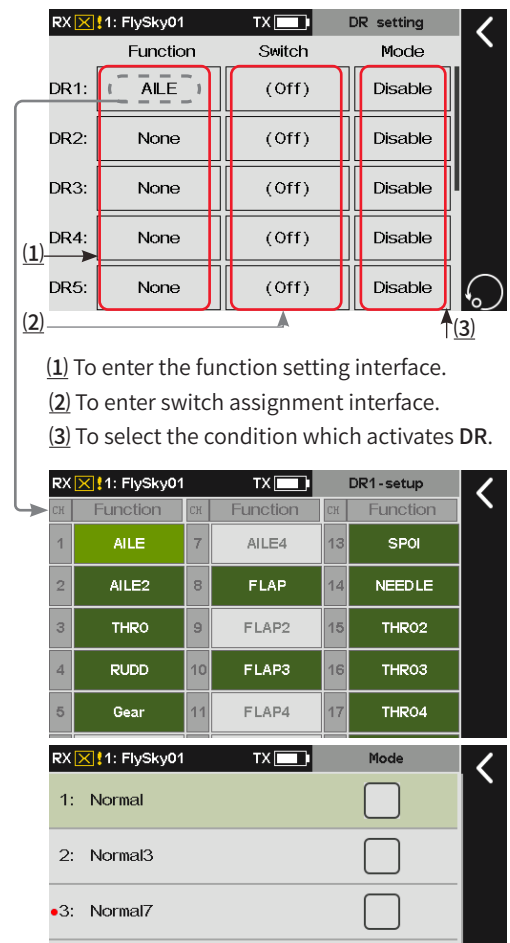

8.5 Channel Offset

This function allows you to adjust the offset value of each channel, and you can set different offset value in different conditions. The offset value caused by the model can be corrected using this function. If the offset value is set too much, the control amount of the channel will be reduced. If the offset value caused by the model is large, please try to adjust the model first.

Function setup:

1. Tap a channel you want to adjust to enter.
2. Click + or - to change the offset value to the desired point. Then click  to return to the previous interface.

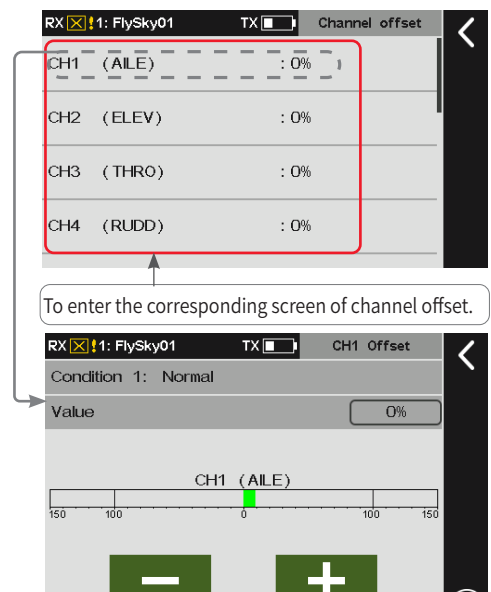

8.6 Program Mixes

Note: The TEL item is added for version 1.0.70 or later.

A new special control combo can be created to correct the disadvantages of the model. You can select a stick/knob or a function as a **Master**. When selecting a function, you can set whether other mixes associated with the function affect the **Slave** of the same group and whether the trim affects the **Slave**. The function can be used to set the servo change of the **Master** mapping to the **Slave** channel through a custom curve. You can set a switch to enable/disable the **Mix**, and set the delay to enable/disable the **Mix** function. Please note if the master is set to a slow action by **Set by function** in the **Servo speed** function, the **Slave** will also follow the **Master** to perform the slow action.

It can be used for a variety of applications: **link** with other mixes, separate link settings for the master and slave with reversal direction of the connection; trim mode enabled or disabled; and curve mixing rate and mixing delay can be set separately for each group of **Mix**.

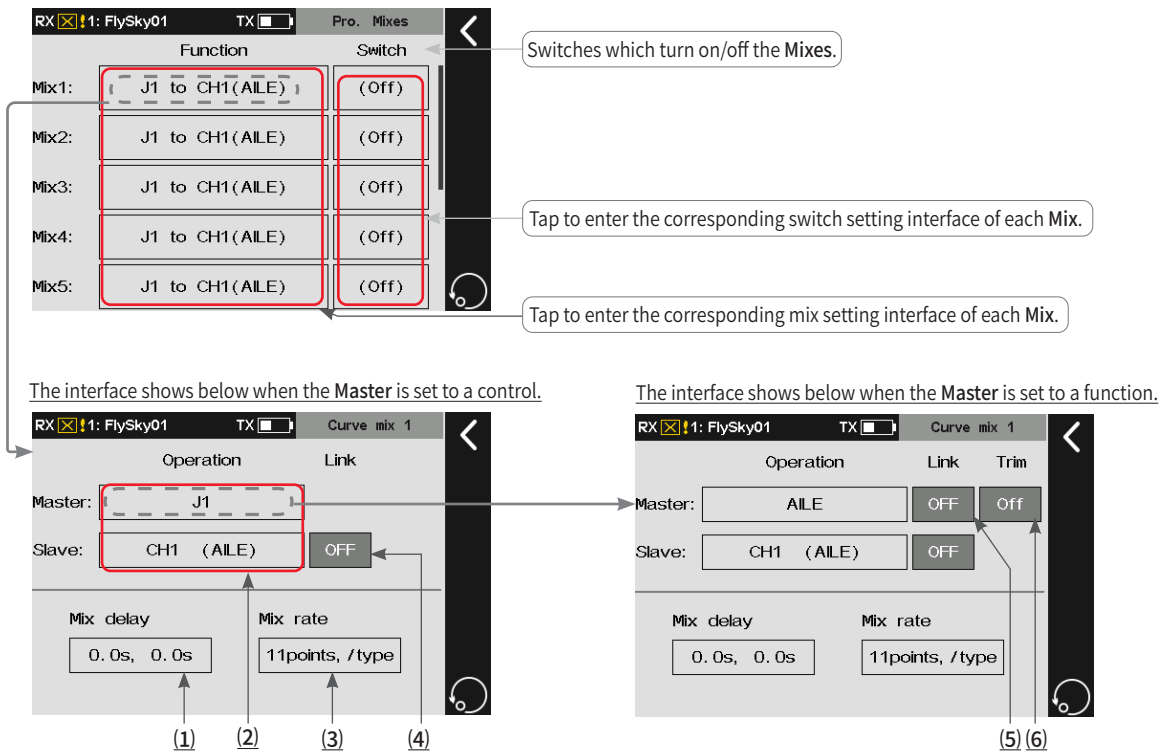

- (1) Tap to enter the interface of **Mix delay**.
- (2) Click to enter the corresponding interface of **Master** or **Slave**.
- (3) Tap to enter the interface of **Mix rate**.
- (4) Tap to set the link mode of **Slave** to **Master**.
- (5) Tap to set the link mode of **Master** to **Slave**.
- (6) Tap to set to turn on/off the trim of **Master**.

Note: When the **Mix** activates and the trim of its **Master** is set to **On**, the trim of its Mater will affect its **Slave**. If the trim is set to **Off**, the trim of **Master** will not affect the **Slave**.

8.6.1 Setting Master And Slave

Set related settings of **Master** and **Slave**.

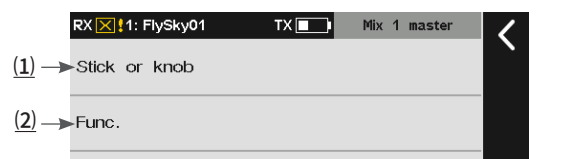

- (1) Tap to enter the screen of setting **Master's** control.
- (2) Click to enter the screen of setting **Master's** function.



微信公众号



Bilibili



Website





Facebook

Master Selection

Set related settings of **Master**. **Master** can be set to a control or a function.

Function setup:

1. Tap the function box next to **Master** to enter.
2. Tap **Stick or Knob** to enter if you want to set **Master** to a control. Tap the desired control or knob you want to set. Then click  to return to the previous interface.
3. Tap **Func.**(function) to enter if you want to set **Master** to a function. Tap the desired function you want to set. Then click  to return to the previous interface.

For **Slave**, you can only set it to a function, for the function setting of **Slave**, please refer to the descriptions of **Master** above.

Note: When **Master** is set as a control, the **Link** and **Trim** function are disabled, that is, it will not appear **Link** and **Trim** items.



Master Link/Slave Link

The link can be set for **Master** and **Slave**, when **Master** is set to a specific function. The **Link** is to set whether the master function will affect the slave function when it is affected by other mixes. **Slave Link** is to achieve the result of this group of mixers used as a source of link for other mixers to select this group of slave functions as its master.

Function setup:

Tap the function box below **Master Link**. You can click repeatedly toggle among **NOR**(normal), **REV**(reverse) or **OFF**.

Note: **Nor**(normal) refers to a forward call, and **REV**(reverse) refers to a reverse call. When **Master Link** is set to **OFF**, other function mixing volume will not affect **Slave**.

Take the link setting between **Mix1** and **Mix2** as an example.

Mix1			Mix2		
Master	Func.	RUDD	Master	Func.	AILE
	Link	OFF		Link	NOR/REV
Slave	Func.	AILE	Slave	Func.	THRO
	Link	NOR/REV		Link	OFF

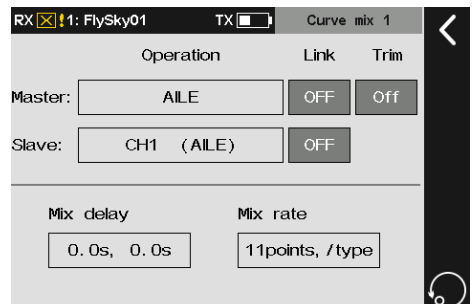

Master Trim

Set related trim settings of **Master**.

Function setup:

Tap the function box below **Master Trim**. You can click repeatedly toggle between **Off** or **On**.

Note: When the trim is set to **On**, **Master** trim changes will also affect **Slave**. When it is set to **Off**, **Master** trim changes will not affect **Slave**.



8.6.2 Setting Mix Delay

Set the delay time for the current condition from triggering to taking effect for **Open delay** or **Close delay** of the **Mix**. If the **Mix delay** needs to be set for other conditions, switch to other conditions prior to settings.

Function setup:

1. Tap **Open delay** or **Close delay**.
2. Click **+** or **-** to set the appropriate value. Then click  to return to the previous interface.

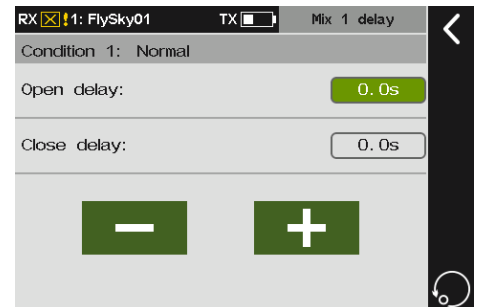

8.6.3 Setting Mix Rate

Set the mix rate for the channel for the current condition.

Function setup:

1. Tap **Line type** to enter the interface if you want to change the line type and amount of the dots.
2. Tap the appropriate item and click **Yes** in the pop-up menu to complete.
3. Tap **Rate** or **Offset**.
4. Tap **«** or **»** to select a dot.
5. Click **+** or **-** to set the appropriate value. Then click  to return to the previous interface.

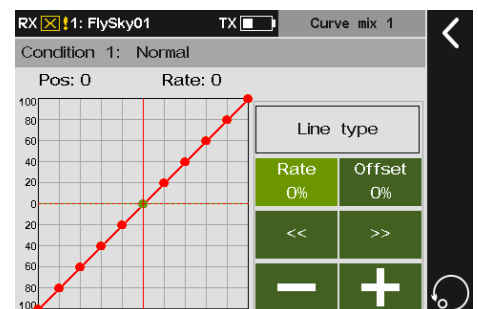

If the models are the multi-aileron, multi-elevation or multi-flap structure, you can set the mix through the aileron, flap and elevation mix function when the mixes are required for aileron, elevation and flap.

8.7 Servo Speed

Note: This function is available for version 1.0.65 or later.

Introduce the settings of the **Servo speed** function. Usually, you can use this function if you want to simulate the movement of a real aircraft, and you can use this function to set some maneuvering parts that need to change slowly.

Set by Function

Set the slow action of the main function of the model. After settings, all the channel volumes related to this function will execute the slow action.

Set by Channel

Executes the slow action of all the volumes output from this channel.

Set the speed for condition change

Execute the slow action of all the related channel volumes when switching from one condition to another condition.

Note: The corresponding function interfaces vary with model structures (for example, an aircraft with or without a tail).

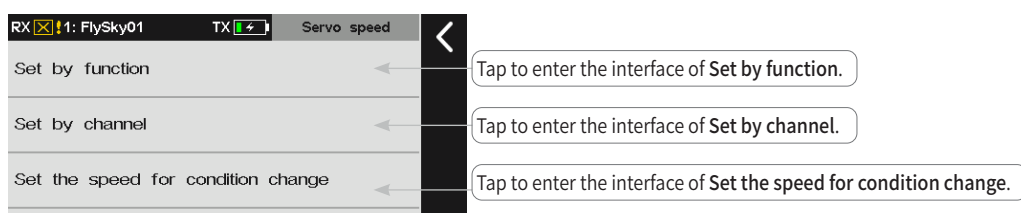

微信公众号



Bilibili



Website



Facebook

8.7.1 Servo Speed- Set By Function

This can reduce the output speed of some main functions (such as aileron, throttle, rudder, spoiler, etc.). The slow action times of start(**In speed**) and recovery(**Out speed**) can be set separately, that is, the slow action time can be changed by different start and recovery speeds.

After setting the delay for the master function, all channel outputs associated with this function will have the slow actions. If the **Pro. Mixes** uses this main function as the master, the slave outputs of the same group will also have the slow actions. For example, if you set the aileron function delay time to 2S, the corresponding slave outputs of the aileron functions such as **Aileron to Elevator**, **Aileron to Rudder** and other mix functions will also change slowly.

Function setup:

1. Tap item you want to set to enter.
2. Tap the function box next to **In speed**, then click + or - to set the time.
3. Tap the function box next to **Out speed**, then Tap + or - to set the time.
4. Tap the function box next to **Type**, then click  to return to the previous interface.

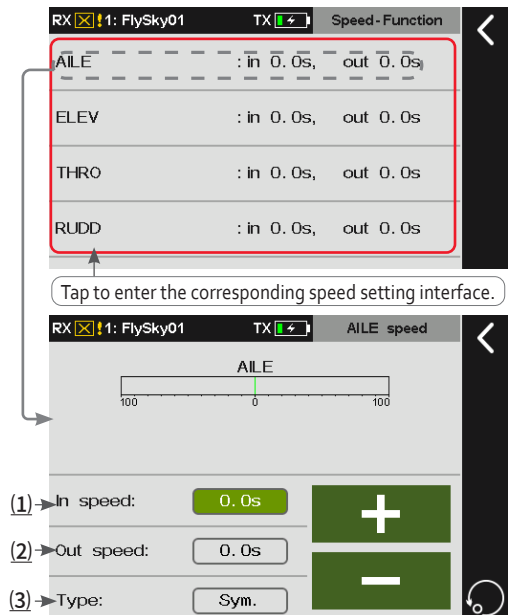

- (1) Tap to select **In speed**, the shorter time is, the faster speed is.
- (2) Tap to select **Out speed**, the shorter time is, the faster speed is.
- (3) Tap to toggle between **Line** and **Sym.** (symmetry). **Sym** means the neutral (ratio: 0%) is the reference point. **Line** means the low end (ratio: smallest value) is the reference point.

Note: Recovery refers to the value change from far from the reference point to close to the reference point, which is output by **Out speed**. Start refers to the value change from close to the reference point to far from the reference point, which is output by **In speed**.

After setting, the interface shows below when push/pull the control which is assigned to the channel.

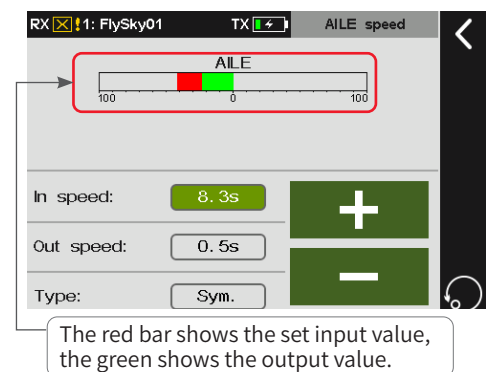

8.7.2 Servo Speed- Set By Channel

This can reduce the output speed of channels (such as CH1, CH2, etc.). The slow action times of start and recovery can be set separately, that is, the slow action time can be changed by different start and recovery speeds.

You can use this function if you want to simulate the movement of a real aircraft or make up the mechanical virtual position of the servo.



After setting the slow action time, all the volumes output from this channel execute the slow action.

Function setup:

1. Tap item you want to set to enter.
2. Tap **In speed**, then click + or - to set the appropriate time.
3. Tap **Out speed**, then click + or - to set the appropriate time.
4. Tap the function box next to **Type**, then click to return to the previous interface.

8.7.3 Servo Speed- Set By Condition

This can reduce the output speed of channels which is changed caused by condition switching.

You can use this function for some special flight which is in smooth transition. For example, it recommends that you should use this function if you want to switch from condition1 to condition2 for the airplane model.

Function setup:

1. Tap item you want to set to enter.
2. Tap **In speed**, then click + or - to set the appropriate time.
3. Tap **Out speed**, then click + or - to set the appropriate time.
4. Tap the function box next to **Type**, then click to return to the previous interface.

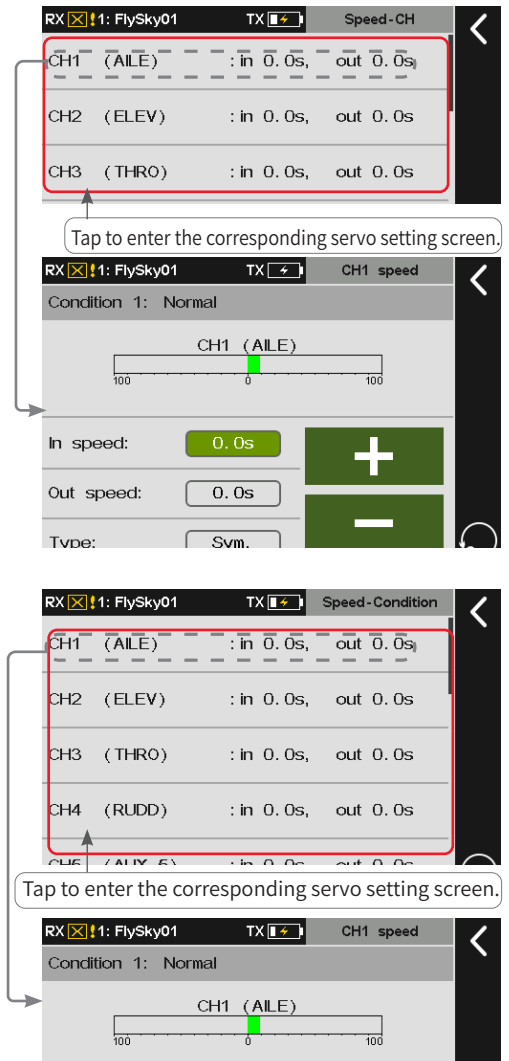

8.8 Throttle Curve Note: This function is available for version 1.0.65 or later.

This function allows the throttle control lever to respond to engine speed changes more as expected to achieve the best results in the control of the engine. Different input and output rate factors (up to 11 points) are set through multi-point curves. The throttle curve will operate on input values of all control levers assigned to the throttle function before the next step (**Func. rate**). The multi-engine model throttle curve will operate for all throttle control levers. This setting is for the current condition. For the settings of other conditions, switch to other conditions first and then carry out the settings.

Function setup:

1. Tap **Line type** to enter the interface if you want to change the line type and amount of the dots.
2. Tap the appropriate item and click **Yes** in the pop-up menu to complete.
3. Click **Rate** or **Offset**.
4. Click or to select a dot.
5. Tap + or - to set the appropriate value. Then click to return to the previous interface.

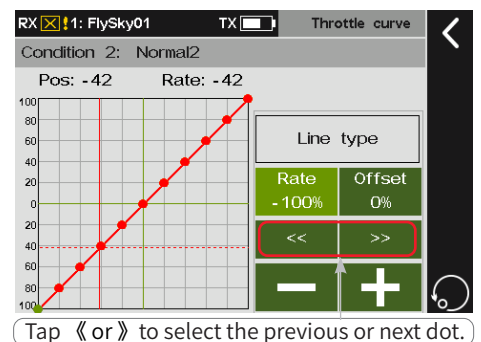

Note: The horizontal axis represents the input value of the throttle stick. The vertical axis represents the output value of the throttle after calculation.



微信公众号



Bilibili



Website



Facebook



8.9 Throttle Cut

Note: This function is available for version 1.0.65 or later.

This function is a special setting for oil-operated engine. The **Cut switch**, **Cut position** and **Cut Threshold** can be set. When the throttle control stick is within the throttle cut threshold, toggle the throttle cut switch to turn off the engine. The output value of the throttle function when the throttle cut is in effect is the throttle cut position value. It will be limited by the channel reverse function and the channel range function, and all other volumes operated to the channel corresponding to this throttle are invalid. However, the other functions of throttle mixing are still worked.

Multi-engine model can be set with the throttle cut separately for throttle, throttle 2, throttle 3 and throttle 4.

Function setup:

1. Tap the function box next to **Cut switch** to enter.
2. Set a switch to turn on or off the **Throttle cut**. Then tap  to return to the previous interface.
3. Tap the function box next to **Cut position**, then click **+** or **-** to set the appropriate value. Click  to return to the previous interface.
4. Toggle the switch to confirm whether it works properly.

Notes:

1. When multiple throttles are set, choose **Model > Type > Optional**, and click **Throttle**, to select the appropriate number of throttles. After setting, this interface will show multiple throttles. Click the corresponding throttle to set them separately. Refer to the above for settings.
2. For settings of switch, refer to the descriptions in chapter 16.

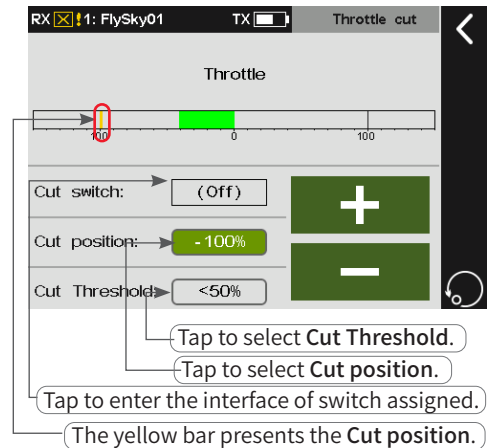

The interface for multiple throttle

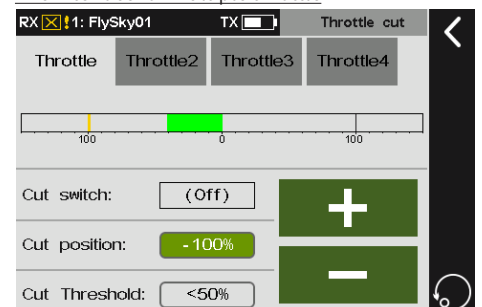

8.10 Idle Up

Note: This function is available for version 1.0.65 or later.

This function can be used to set the throttle idle position, which can prevent the engine from shutting down when the throttle stick is in a lower position. The minimum throttle position is defined by setting the offset value. Once this function is activated, the minimum throttle setting (idle point) will be determined by the offset value, expressed as a percentage. For safety reasons, this function will work only when the throttle stick is below the lower position (-20%). The idle speed offset values of -100-0-100 correspond to a ratio factor of 80%-100-120%. The throttle control ratio will be multiplied with the ratio factor corresponding to the offset when the idle speed is enabled for the subsequent operation (throttle curve). When the throttle cut is enabled, the throttle hold and this function are not valid.

In multi-engine model, the idle switch is recognized only in the "throttle" control position (below -20%), and the throttle, throttle 2, throttle 3 and throttle 4 will be calculated when the idle is enabled.

Function setup:

1. Tap the function box next to **Idle switch** to enter.
2. Set a switch to turn on or off the **Idle up**. Then click  to



return to the previous interface.

3. Tap the function box next to **Offset**, then click + or - to set the appropriate value. Click  to return to the previous interface.

Note: For settings of switch, refer to the descriptions in chapter 16.

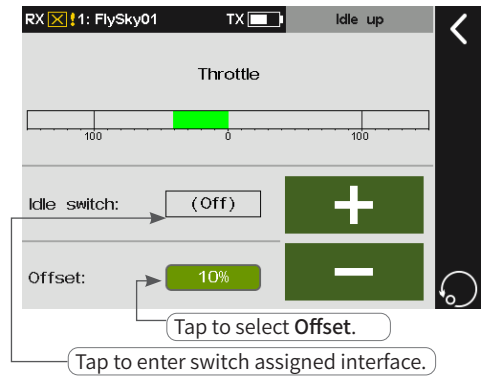

Note: If the offset value is negative, it means the idle speed is rising. When the offset value is maximum, it indicates that the throttle stick is close to the minimum throttle.

8.11 Throttle Needle

Note: This function is available for version 1.0.65 or later.

The throttle needle function is set for some models with a throttle needle. This function is used to set the output rate of the throttle needle master control in a multi-point curve method.

For example, if you need to link a throttle to a needle, you can assign the throttle needle controlled by the throttle stick, and realize the control of the throttle stick to the needle by setting the curve.

The setting steps of throttle needle are similar to the setting steps of throttle curve. Refer to the related settings of throttle curve.

8.12 Aileron

Note: This function is available for version 1.0.65 or later.

This section introduces the settings of the aileron and its mixes function. The parameter settings of this function are for the current condition. To set in another condition, you need to switch the condition first.

Note: Due to the different model structures (for example, different number of ailerons and flaps), the corresponding function interface may be different. Usually, up to four ailerons are described as an example.

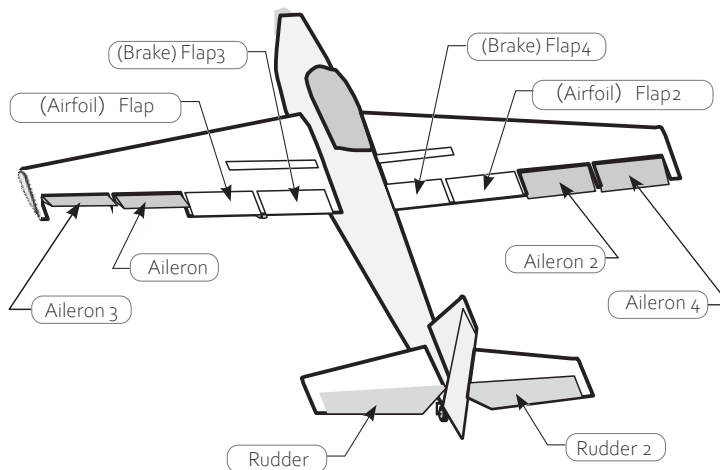

微信公众号



Bilibili



Website



Facebook

8.12.1 Aileron Differential

The left and right ailerons of the aircraft or glider can be adjusted independently. The differential aileron adjustment can be achieved by setting different high and low rate values for each aileron.

Take the setting of **Low** as an example.

Function setup:

1. Tap the item corresponding to **Low** you want to set, The currently selected function item is highlighted in light green.
2. Click + or - to set the appropriate value. Then click  to return to the previous interface.

For the setting of **High**, refer to the setting of **Low**.

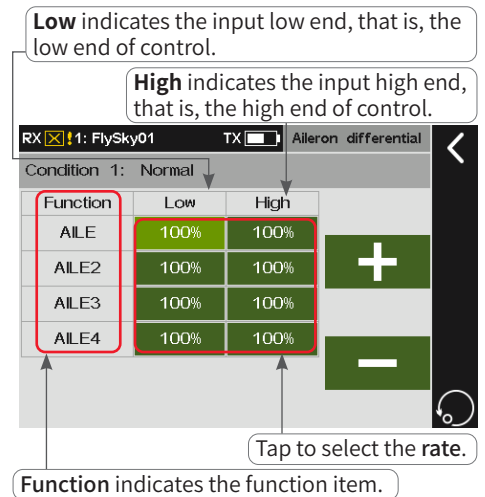

Note: "Function", "Low (low end rate)" and "High (high end rate)" in the interface of the Aileron, Flap, Elevation, Spoiler, and Rudder functions have similar meanings.

8.12.2 Aileron Elevator

Sets the elevator with the aileron function to improve the model's roll performance. Only the aircraft with the two elevator tails supports this function. You can set the high and low rate values of the two elevators to move with the aileron function.

Take the setting of **Low** as an example.

Function setup:

1. Tap the item corresponding to **Low** you want to set, The currently selected function item is highlighted in light green.
2. Click + or - to set the appropriate value. Then click  to return to the previous interface.

For the setting of **High**, refer to the setting of **Low**.

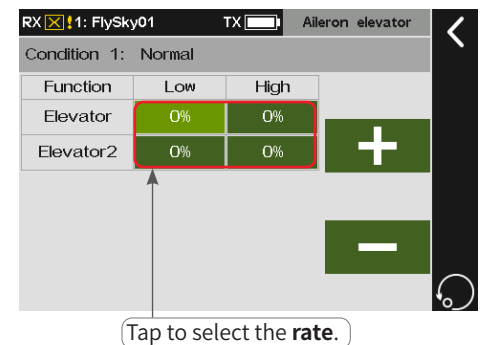

8.12.3 Aileron Camber Flap

This mixes function is used to set the linkage between the camber flap and the aileron so that the flap can work together with the aileron, thus improving the maneuvering characteristics around the longitudinal axis.

Note: This function is only available with 2 cambers and 4 flaps.

Take the setting of **Low** as an example.

Function setup:

1. Tap the item corresponding to **Low** you want to set, The currently selected function item is highlighted in light green.
2. Click + or - to set the appropriate value. Then click  to return to the previous interface.

For the setting of **High**, refer to the setting of **Low**.

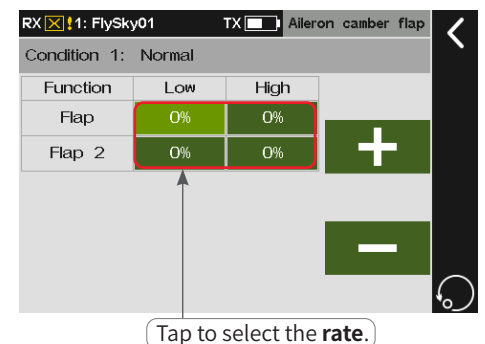

8.12.4 Aileron Brake Flap

This mixes function is used to set the linkage between the brake flap and the aileron so that the flap can work together with the aileron, thus improving the maneuvering characteristics around the longitudinal axis.

Note: This function is only available with 4 flaps.

Take the setting of **Low** as an example.

Function setup:

1. Tap the item corresponding to **Low** you want to set, The currently selected function item is highlighted in light green.
2. Click + or - to set the appropriate value. Then click  to return to the previous interface.

For the setting of **High**, refer to the setting of **Low**.

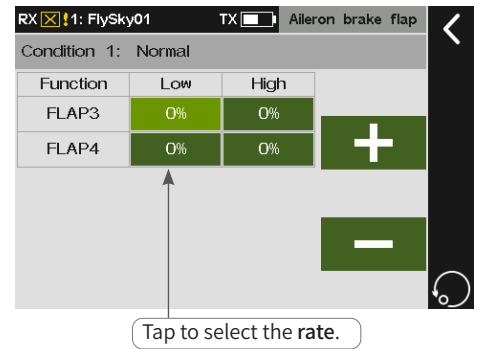

8.12.5 Aileron To Elevator

Usually more lift is needed on ailerons when turning/rolling. This function allows you to set the compensation rate of the elevator during aileron movement, so that the elevator will be subject to a compensatory trim according to the set rate during aileron movement, thus preventing the nose-down of the aircraft.

Note: If the model structure is a tailless (flying wing) aircraft, the aileron can be used as an elevator. This setting will affect all elevator surfaces, and even the aileron surfaces in case of a tailless aircraft.

Take the setting of **Low** as an example.

Function setup:

1. Tap the item corresponding to **Low** you want to set, The currently selected function item is highlighted in light green.
2. Click + or - to set the appropriate value.
3. Set a switch to enable this function. Tap the box next to **Start switch** to enter switch assigning interface. Then click  to return to the previous interface.

Note: For settings of switch, refer to the descriptions in chapter 16.

For the setting of **High**, refer to the setting of **Low**.

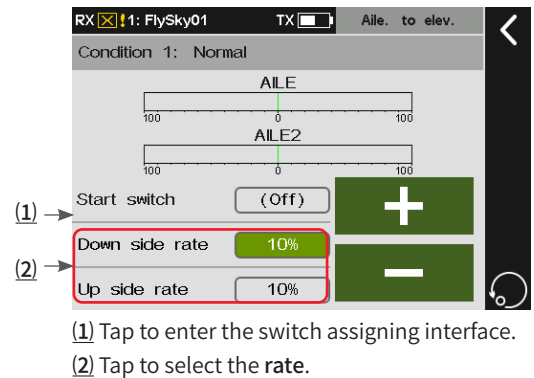

(1) Tap to enter the switch assigning interface.

(2) Tap to select the rate.

8.12.6 Aileron To Rudder

This mixes function is used to set the linkage between the steering servo and the aileron. This function can be set to achieve the more coordinated and flexible steering and roll through the compensatory trim of the steering servo during the aileron movement.

Note: When there are two rudders, rudder 1 and 2 will both be affected.

Take the setting of **Low** as an example.

Function setup:

1. Tap the item corresponding to **Low** you want to set, The

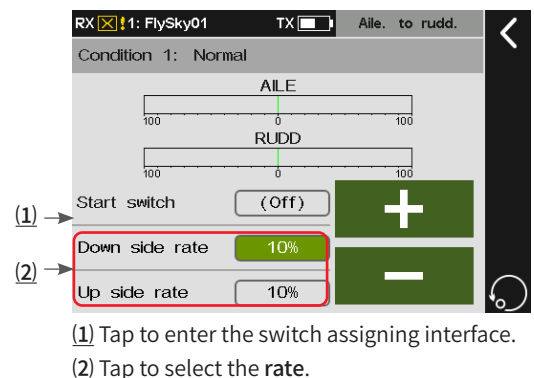

(1) Tap to enter the switch assigning interface.

(2) Tap to select the rate.



微信公众号



Bilibili



Website



Facebook

currently function item selected is highlighted in light green.

2. Click + or - to set the appropriate value.
3. Set a switch to enable this function. Tap the box next to **Start switch** to enter switch assigning interface. Then click  to return to the previous interface.

Note: For settings of switch, refer to the descriptions in chapter 16.

For the setting of **High**, refer to the setting of **Low**.

8.13 Flap

Note: This function is available for version 1.0.65 or later.

This section introduces the settings of the flap and its mixes function. The parameter settings of this function are for the current condition. To set in another condition, you need to switch the condition first.

Note: Due to the different model structures (for example, different number of ailerons and flaps), the corresponding function interface may be different. Usually, up to four ailerons are described as an example.

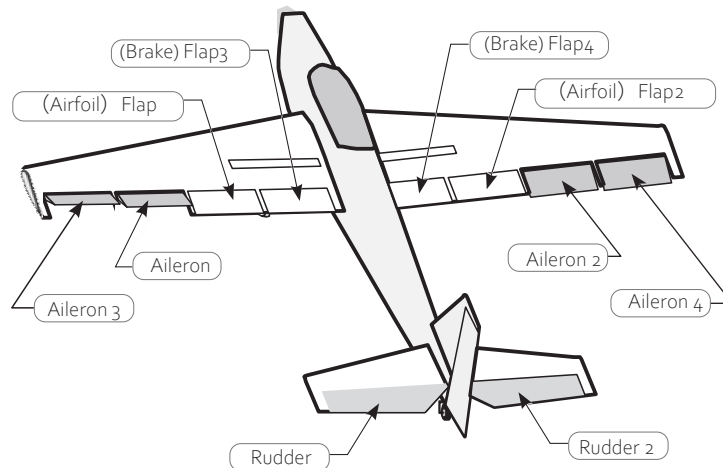

8.13.1 Flap Setting

This function is used to set the high and low end rates and offset of flaps separately, that is, for a model with multiple flaps, the flap upward and downward movement travel and neutral point position on each flap can be adjusted independently.

Note: The number of interface flap function items is related to the Wing through Models.

Take the setting of **Low** as an example.

Function setup:

1. Tap the item corresponding to **Low** you want to set, The currently selected function item is highlighted in light green.
2. Click + or - to set the appropriate value. Then click  to return to the previous interface.

For the setting of **High** and **Offset**, refer to the setting of **Low**.

Offset indicates the input which centers on the neutral position will move lower or higher according to the offset value.

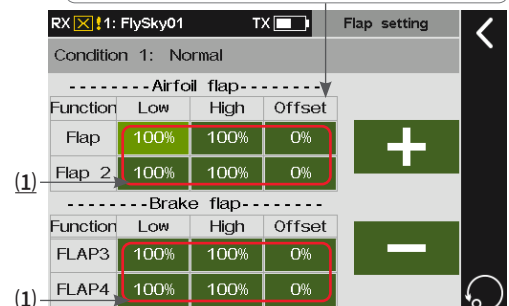

(1) Tap to select the rate.

Note: Offset in the interface of the Flap and Airbrake has similar meanings.



8.13.2 Brake To Airfoil

This mixes function is used to set the high to low rate of brake flaps to airfoil flaps. It is used to adjust the up/down movement travel range of multiple flaps independently.

Note: This function is only available with 4 flaps.

Take the setting of **Low** as an example.

Function setup:

1. Tap the item corresponding to **Low** you want to set, The currently selected function item is highlighted in light green.
2. Click + or - to set the appropriate value.
3. Set a switch to enable this function. Tap the box next to **Start switch** to enter switch assigning interface. Then click  to return to the previous interface.

Note: For settings of switch, refer to the descriptions in chapter 16.

For the setting of **High**, refer to the setting of **Low**.

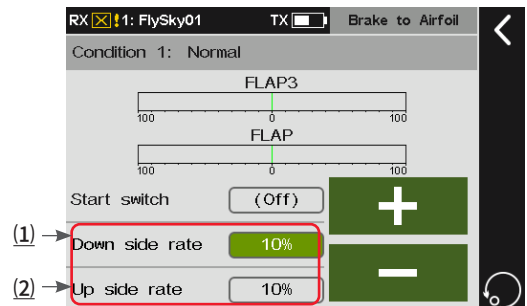

- (1) Tap to enter the switch assigning interface.
- (2) Tap to select the rate.

8.13.3 Airfoil To Elevator

This mixes function is used to set the linkage between the wing flap and elevator. You can set a compensatory trim for the elevator to prevent the aircraft from diving when the airfoil flap is operated to slow down.

Note: For normal tail/V tail/double elevator tails, the function item is only Elevator/Elevator 2. For those having aileron but without tail (There is no elevator function item, the number of aileron function items depends on the actual number of ailerons), set the aileron as the elevator, so as to achieve the Airfoil to Elevator function.

Take the setting of **Low** as an example.

Function setup:

1. Tap the item corresponding to **Low** you want to set, The currently selected function item is highlighted in light green.
2. Click + or - to set the appropriate value. Then click  to return to the previous interface.

For the setting of **High**, refer to the setting of **Low**.

The interface is for the model has elevators.

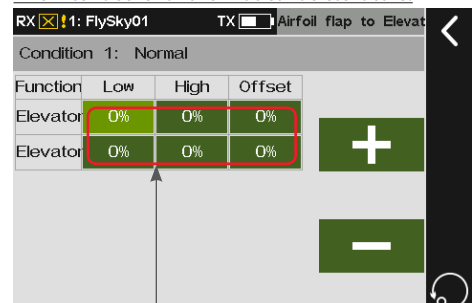

Tap the output rate item for each elevator linked with the airfoil flaps.

The interface is for the model has no elevators.

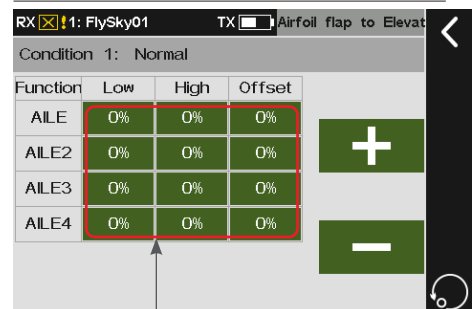

Tap the output rate item for each aileron linked with the airfoil flaps.



微信公众号



Bilibili



Website



Facebook

8.13.4 Brake Flap To Elevator

This mixes function is used to set the linkage between the brake flap and elevator. You can set a compensatory trim for the elevator to prevent the aircraft from diving when the brake flap is operated to slow down.

Note: This function is only available with 4 flaps.

Take the setting of **Low** as an example.

Function setup:

1. Tap the item corresponding to **Low** you want to set, The currently selected function item is highlighted in light green.
2. Click **+** or **-** to set the appropriate value. Then click  to return to the previous interface.

For the setting of **High** and **Offset**, refer to the setting of **Low**.

The interface is for the model has elevators.

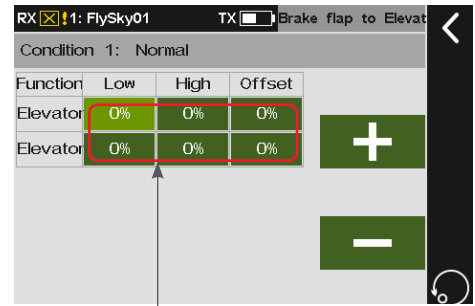

Tap the output rate item for each elevator linked with the brake flaps.

The interface is for the model has no elevators.

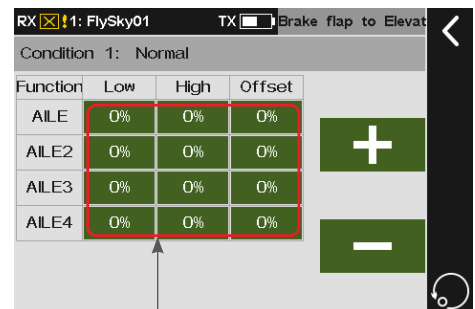

Tap the output rate item for each aileron linked with the brake flaps.

8.14 Airbrake Note: This function is available for version 1.0.65 or later.

When the control model is ready to descend or land, the air brake function can be used to help decelerate. This function is achieved by setting the offset values of ilerons, spoilers and elevators.

The offset values of ailerons, flaps, spoilers and elevators can be set in two sets. Enable/disable the Airbrake and switch between different offsets by assigning controls.

Notes:

1. Due to the different model structures (for example, different number of ailerons), the corresponding function menu may be different. Usually, up to four ailerons are described as an example.
2. Two brake rates can be realized by setting a three-position switch with two positions corresponding to offset 1/offset 2 respectively.

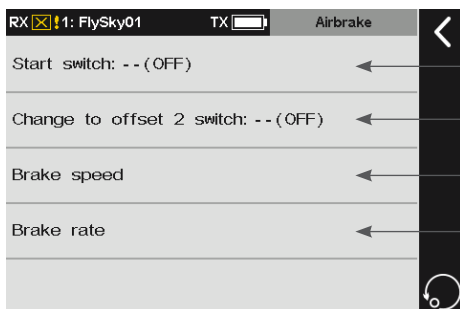

Tap to enter switch assignment interface of enabling/disabling the Airbrake.

Tap to enter switch assignment interface of switching between Offset1 and Offset2.

Tap to enter the interface of setting Brake speed.

Tap to enter the interface of setting Brake rate.

Note: For settings of switch, refer to the descriptions in chapter 16.



8.14.1 Brake Speed

Sets the parameters related to the brake speed function. You can set the time to complete the action when the brake is enabled and disabled. The longer the time, the slower the speed.

Take the setting of **Offset 1 brake** as an example.

Function setup:

1. Tap **Offset 1 brake**, the currently selected function item is highlighted in light green.
2. Click **+** or **-** to set the appropriate value. Then click  to return to the previous interface.

For the setting of **Offset 2 brake** and **Stop braking**, refer to the setting of **Offset 1 brake**.



(1) Tap to select **Offset 1 brake**.

(2) Tap to select **Offset 2 brake**.

(3) Tap to select **Stop braking**.

8.14.2 Brake Rate

Sets the offsets of **AILE**, **Flap**, **Spoiler** and **Elevator** for the current condition. To set in another mode, you need to switch the condition first.

Take the setting of **Offset 1 brake** of **AILE** as an example.

Function setup:

1. Tap the function box corresponding to **AILE**, the currently selected function item is highlighted in light green.
2. Click **+** or **-** to set the appropriate value. Then click  to return to the previous interface.

For the setting of offset value of other function, refer to the description above.

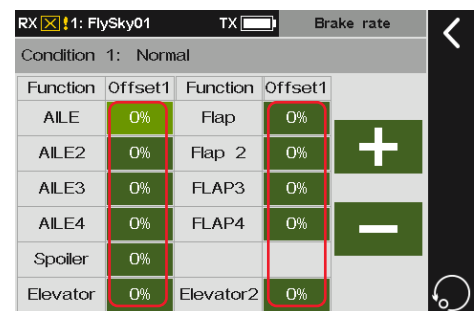

Tap to select **Offset** for the corresponding function.

8.15 Spoiler Note: This function is available for version 1.0.65 or later.

Spoiler, also called deceleration flap, can achieve fast braking by increasing the aircraft pressure on the ground when the aircraft is descending. Meanwhile, the use of spoiler in flight can also achieve the effect of aircraft deceleration. This function can be used to set the upward and downward movements of each spoiler and the linkage between spoiler and elevator. If the spoiler is used during deceleration, the aircraft will tend to dive. If the elevator linkage is set, the flight attitude can be controlled through the compensatory trim of the elevator. The function parameter setting is for the current condition. To set in another condition, you need to switch the condition first.

Notes:

1. Due to the different model structures (for example, different number of ailerons), the corresponding function menu may be different. Usually, up to four ailerons are described as an example.
2. If it is a flying wing type aircraft, the elevation setting item is aileron; or, use the flap function to add setting interfaces for the aircraft.



微信公众号



Bilibili



Website



Facebook

Take the setting of **Low** as an example.

Function setup:

1. Tap the item corresponding to **Low** you want to set, The currently selected function item is highlighted in light green.
2. Click **+** or **-** to set the appropriate value. Then click  to return to the previous interface.

For the setting of **High**, refer to the setting of **Low**.

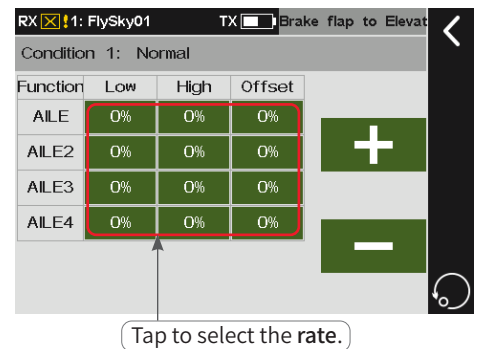
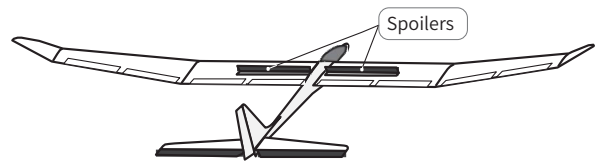

8.16 Elevator

Note: This function is available for version 1.0.65 or later.

This section introduces the settings of the elevator and its mixes function. The parameter settings of this function are for the current condition. To set in another condition, you need to switch the condition first.

Notes:

1. Due to the different model structures (for example, different number of ailerons and flaps), the corresponding function menu may be different.
2. The aileron movement mode is not restricted in the mixing linkage of the elevator and aileron.

8.16.1 Elev. Linkage

This mixes function is used to adjust the rise and fall rates of left and right elevators separately.

Take the setting of **Low** as an example.

Function setup:

1. Tap the function box corresponding to **Low** you want to set, the currently selected function item is highlighted in light green.
2. Click **+** or **-** to set the appropriate value. Then click  to return to the previous interface.

For the setting of **High**, refer to the description above.

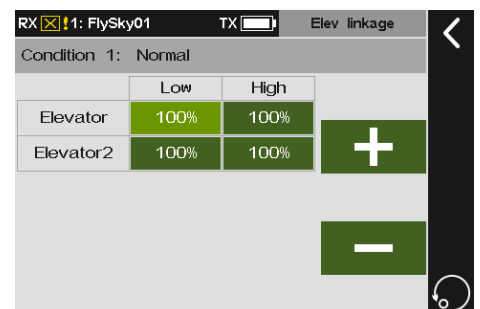

8.16.2 Elev. Aileron

This mixes function is used to set the linkage between the elevator and aileron. For the models with elevator, the elevator can link the aileron to move homodromously to increase the lift. For the models without tail, the aileron 2 master control can be used to link the aileron to move homodromously to achieve the rise and fall function.

Note: This function item is not available for single aileron models. For multi-aileron models, the number of aileron function items depends on the actual number of ailerons.

Take the setting of **Low** as an example.

Function setup:

1. Tap the function box corresponding to **Low** you want to set, the currently selected function item is highlighted in light green.
2. Click + or - to set the appropriate value. Then click  to return to the previous interface.

The interface is for the model has tail wings.

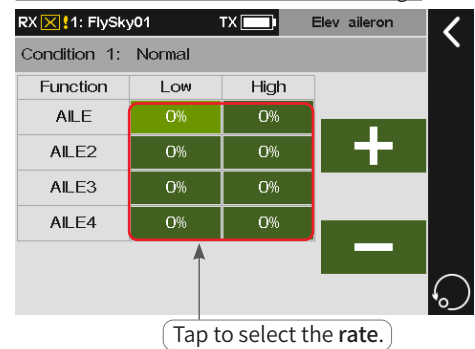

The interface is for the model has no tail wings.

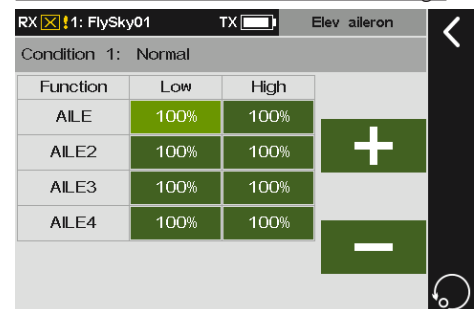

8.16.3 Elev. To Airfoil Flap

This mixes function is used to set the linkage between the elevator and wing flap. When this function is enabled, the elevator/aileron 2 master control of the model will affect the wing flap proportionally, thus increasing the lift of the model.

Note: For tail-less aircraft, aileron 2 is used instead of elevator.

Take the setting of **Low** as an example.

Function setup:

1. Tap the function box corresponding to **Low** you want to set, the currently selected function item is highlighted in light green.
2. Click + or - to set the appropriate value.
3. Set a switch to enable this function. Tap the box next to **Start switch** to enter switch assigning interface. Then click  to return to the previous interface.

Note: For settings of switch, refer to the descriptions in chapter 16.

For the setting of **High**, refer to the setting of **Low**.

The interface is for the model has tail wings.

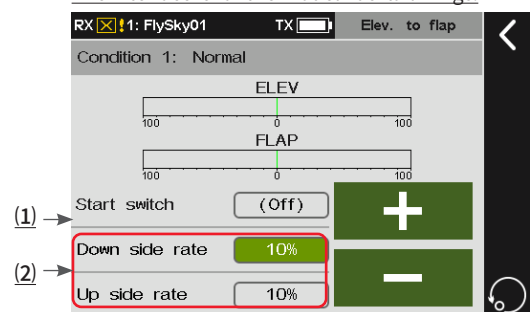

- (1) Tap to enter the switch assigning interface.
- (2) Tap the output rate item for airfoil flap linked with the elevator.

The interface is for the model has no tail wings.

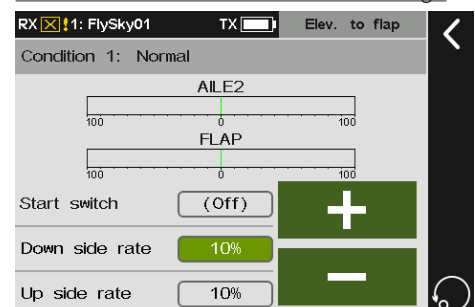

微信公众号



Bilibili



Website



Facebook

8.16.4 Elev. To Brake Flap

This mixes function is used to set the linkage between the elevator and brake flap. When this function is enabled, the elevator/aileron 2 master control of the aircraft model affects the brake flaps in set rate, thus increasing the lift of the aircraft model.

Note: This function is only available with 4 flaps. For tail-less aircraft, aileron 2 is used instead of elevator.

Take the setting of **Low** as an example.

Function setup:

1. Tap the function box corresponding to **Low** you want to set, the currently selected function item is highlighted in light green.
2. Click + or - to set the appropriate value.
3. Set a switch to enable this function. Tap the box next to **Start switch** to enter switch assigning interface. Then click  to return to the previous interface.

Note: For settings of switch, refer to the descriptions in chapter 16.

For the setting of **High**, refer to the setting of **Low**.

The interface is for the model has tail wings.

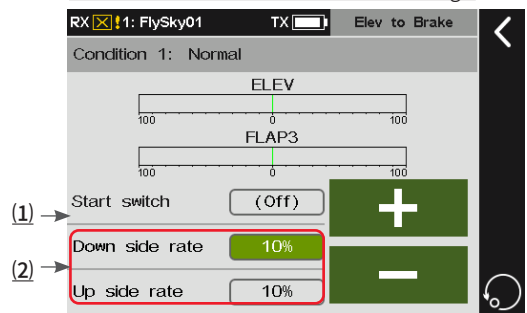

(1) Tap to enter the switch assigning interface.

(2) Tap to select the rate.

The interface is for the model has no tail wings.



8.17 Rudder Note: This function is available for version 1.0.65 or later.

This section introduces the settings of the rudder and its mixes function. The parameter settings of this function are for the current condition. To set in another condition, you need to switch the condition first.

Notes: Due to the different model structures (for example, different number of ailerons and flaps), the corresponding function menu may be different.

8.17.1 Rudd. Linkage

This function is applicable to the model with winglets, and is used to adjust the winglet rudder angle. The winglets are used to solve the wingtip vortex problem, thus reducing the induced drag and improve efficiency. The winglets are usually symmetrically erected vertically at both wingtips or extended outward at a certain angle.

Winglets increase the effective aspect ratio without significantly increasing the wing load and weight. Although the induced drag can be effectively reduced by extending the wing, this will also increase the parasitic drag and wing load strength at the same time, resulting in an insignificant gain. The winglets can effectively increase the aspect ratio without increasing the wingspan.

Note: This function is available for twin-finned airplane.

Take the setting of **Low** as an example.

Function setup:

1. Tap the function box corresponding to **Low** you want to set, the currently selected function item is highlighted in light green.
2. Click + or - to set the appropriate value. Then click  to return to the previous interface.

For the setting of **High**, refer to the description above.

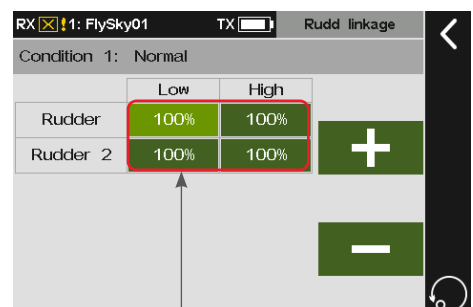

Tap to select the rate item of each rudder.



8.17.2 Rudd. To Aileron

This mixes function is used to set the linkage between the rudder and the aileron. It is used to adjust the rate that all control surfaces affecting the airfoil changes according to the airfoil. You can adjust with the two sides(Up/Down), and meanwhile you can correct the effect of these control surfaces on the direction of flight.

Take the setting of **Low** as an example.

Function setup:

1. Tap the function box corresponding to **Low** you want to set, the currently selected function item is highlighted in light green.
2. Click + or - to set the appropriate value.
3. Set a switch to enable this function. Tap the box next to **Start switch** to enter switch assigning interface. Then click  to return to the previous interface.

Note: For settings of switch, refer to the descriptions in chapter 16.

For the setting of **High**, refer to the description above.

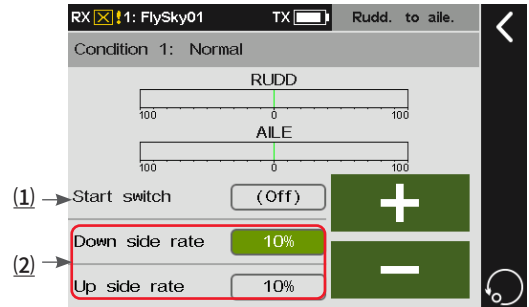

- (1) Tap to enter the switch assigning interface.
- (2) Tap to select the output rate item for aileron linked with the rudder.

8.17.3 Rudd. To Elevator

This mixes function is used to set the linkage between the rudder to elevator. This function is used when it is necessary to realize the linkage between the elevator and rudder, to correct the offset in the pitching direction when the aerobatic model aircraft is turning and flying laterally. For tailless aircraft, aileron 2 is used to replace the elevator to achieve the elevation function.

Take the setting of **Low** as an example.

Function setup:

1. Tap the function box corresponding to **Low** you want to set, the currently selected function item is highlighted in light green.
2. Tap + or - to set the appropriate value.
3. Set a switch to enable this function. Tap the box next to **Start switch** to enter switch assigning interface. Then click  to return to the previous interface.

For the setting of **High**, refer to the description above.

The interface is for the model has tail wings.

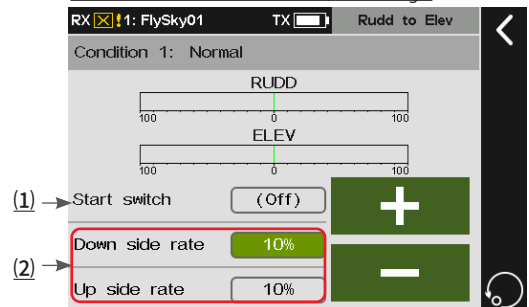

- (1) Tap to enter the switch assigning interface.
- (2) Tap to select the output rate item for elevator linked with the rudder.

The interface is for the model has no tail wings.

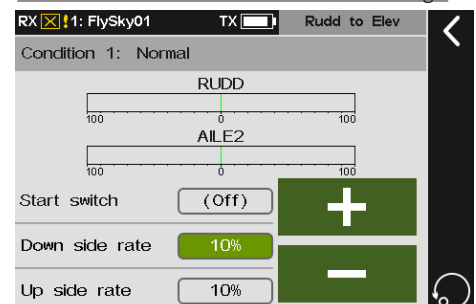

微信公众号



Bilibili



Website



Facebook

8.18 Butterfly

Note: This function is available for version 1.0.65 or later.

This function realizes deceleration by adjusting the rates of ailerons, flaps, spoilers and elevator, i.e., ailerons are raised and flaps are lowered at the same time. This function is very effective when the model is landing, i.e., reducing the speed of the model, more stall margin is provided at the wingtip, thus less risk of wingtip stall. And more lift is generated at the root of the wing, allowing less gliding speed.

Notes: This function is available for multi-flap airplane.

Take the setting of **AILE** as an example.

Function setup:

1. Tap the function box corresponding to **AILE** you want to set, the currently selected function item is highlighted in light green.
2. Click **+** or **-** to set the appropriate value. Then click **↩** to return to the previous interface.

Note: For settings of switch, refer to the descriptions in chapter 16.

For the setting of other function, refer to the description above.

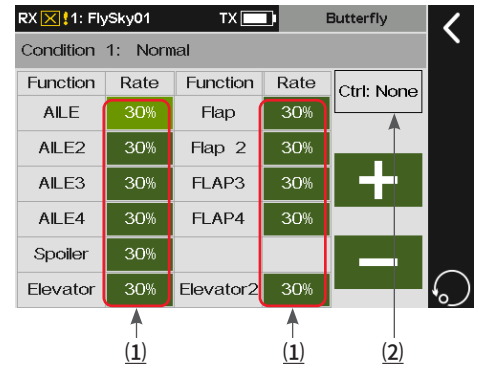

(1) Tap to select the rate.

(2) Tap to enter the switch assigning interface.

Note: The number of ailerons displayed is based on the settings of wing layout.

8.19 V Tail

This function is used to adjust the rate of the V-shaped tail's 2 tail fins in steering and pitching manes. The V-shaped tail aircraft performs the rudder and elevator movements via 2 servos. In this system, one of the tail implements the rudder function and the other performs the elevator function, corresponding to two channels respectively. When the rudder function is implemented, the two control surfaces move in opposite directions. When the elevator function is implemented, the two control surfaces move in the same direction. This interface allows you to set the elevator rate and rudder rate, i.e., the rate of the elevator is for realizing the elevator function and the rate of the rudder is for realizing the rudder function.

Note: This function is available for models with V Tail.

Function setup:

1. Tap **V Tail** to enter the setting interface.
2. Tap **Elevator rate**, then click **+** or **-** to set an appropriate value.
3. Tap **Rudder rate**, then click **+** or **-** to set an appropriate value. Click **↩** to return to the previous interface.

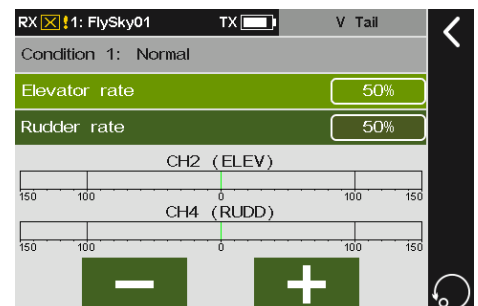



8.20 Logic Switches

Note: Adds a set of logic switch. This is available for version 1.0.65 or later.

A logic switch is a virtual switch consisted of 2 to 4 switches which activates or deactivates according to a mathematical relationship. The system supports to set four groups of logic switches in total. There are three logic difinations between two switches: **AND**, **OR** and **XOR**.

If there is any mathematical logic relationship between certain switch controls and the other two switch controls, this function can be used to express this logic and use it as a logic switch in control. The logic switch can be selected in any menu where switches can be assigned.

Function setup:

1. Tap a logic switch as you desire to set.
2. Tap the top **Select Sw.** to enter and click **One** or **Double** and their positions, then click  to return to the previous interface.
3. Tap the bottom **Select Sw.** and click **One** or **Double** and their positions, then click  to return to the previous interface.
4. Tap a logic difination you want to set: **AND**, **OR** or **XOR**. Refer to the following table for more information on logic difinition and state.
5. Toggle the switches to make sure everything is working as expected.

Note: The setting of a logic switch makes sense only if it is composed of 2 other different switches.

Switch		Logic switch		
Switch 1	Switch 2	AND	OR	XOR
OFF	OFF	OFF	OFF	OFF
OFF	ON	OFF	ON	ON
ON	OFF	OFF	ON	ON
ON	ON	ON	ON	OFF

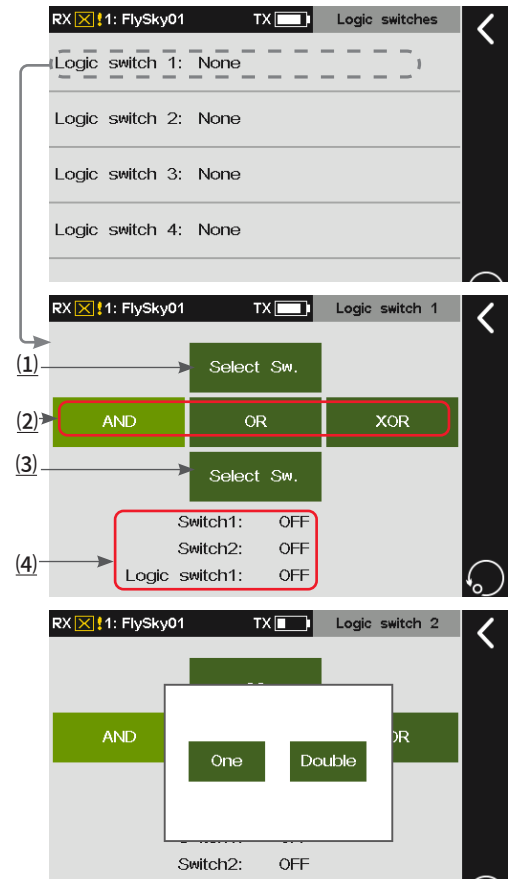

(1) and (3) Tap here to select a switch from the switch selection menu.

(2) Tap here to select a switch from the switch selection menu.

AND If switch 1 and switch 2 are active, then the logic switch will be on. If either switch 1 or switch 2 is off, or switch 1 and switch 2 are both off, the logic switch is off.

OR If either switch 1 or switch 2 is active, or switch 1 and switch 2 are both on, then the logic switch will be on. If switch 1 and switch 2 are both off, the logic switch will be off.

XOR If either switch 1 or switch 2 is active, then the logic switch will be on, but if switch 1 and switch 2 are both active or off, the logic switch will be off.

(4) To display the statuses of switch 1, switch 2 and logic switch 1.



微信公众号



Bilibili



Website





Facebook

8.21 Attitude

This function allows the setting up to 9 output values for channels assigned with attitude functions. The output value of the channel can be switched via the set combo switch.

Function setup:

1. Tap **Attitude** to enter the setting interface.
2. Tap the function box with "--" to enter the switch assignment interface. Tap a switch you want to set or push/pull the physical switch on the transmitter. Click  to return to the previous interface. After these two switches are assigned, the function and its output value are controlled by the combo switch.
3. Change the names of the presets by tapping the dark green function box you want to change. A pop-up menu comes along with it, you can tap the appropriate character then click **Enter** to complete.
4. Click **+** or **-** to set the appropriate value. Use the combo switch to switch the function. Click  to return to the previous interface.

Notes:

1. The rate value indicates the output in percentage of a channel.
2. The combo switch needs to be set before other rate functions can be selected. You can switch 9 output values via this combo switch after the setting is completed.
3. Only toggle switch can be assigned.
4. This function is not available for glider model.

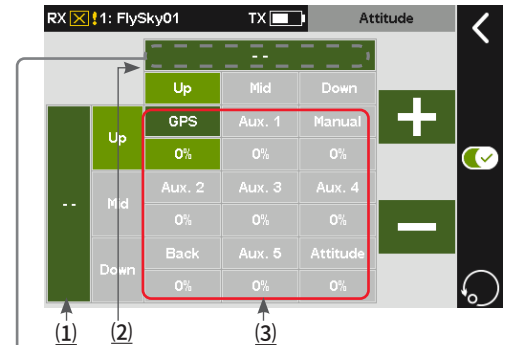

(1) / (2) Tap to enter the switch assignment interface. "--" indicates that the switch is unassigned.

(3) Tap the dark/light green area, you can set the output names of the nine channels.

The switch assignment interface

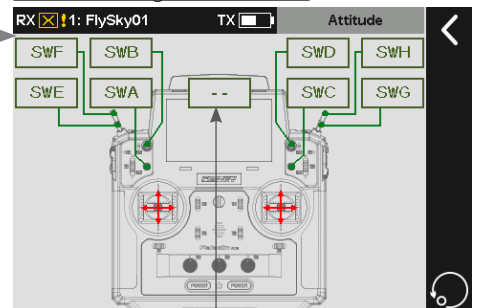

Tap to cancel the assigned switch.

The interface of the switch assigned

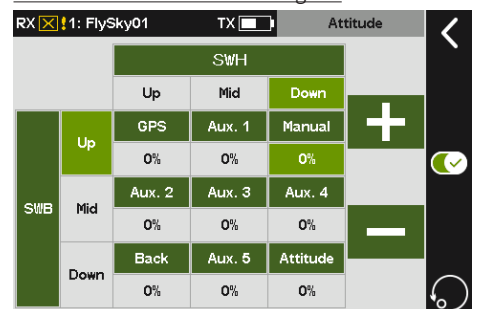



8.22 Telemetry Control

Note: This function is available for version 1.0.70 or later.

This function can convert the transfer-back data into control variable values, you can choose any 2 return values to convert into "TEL1" and "TEL2", and assign this as a control in **Function Assignment**, Switch Assignment, Mixes and other functions. For example, use the temperature sensor to enable the heat sink for cooling.

Function setup:

1. Tap **Telemetry control**.
2. Tap the TEL you want to set to enter the setting interface.
3. Select an appropriate sensor, then click  to return to the parameter setting interface.
4. Tap the parameter, then click + or - to set an appropriate value. Click  to return.

Note: You can set the telemetry as a switch, a control or Master of a Mix to achieve a smart control via the sensor's variable data.

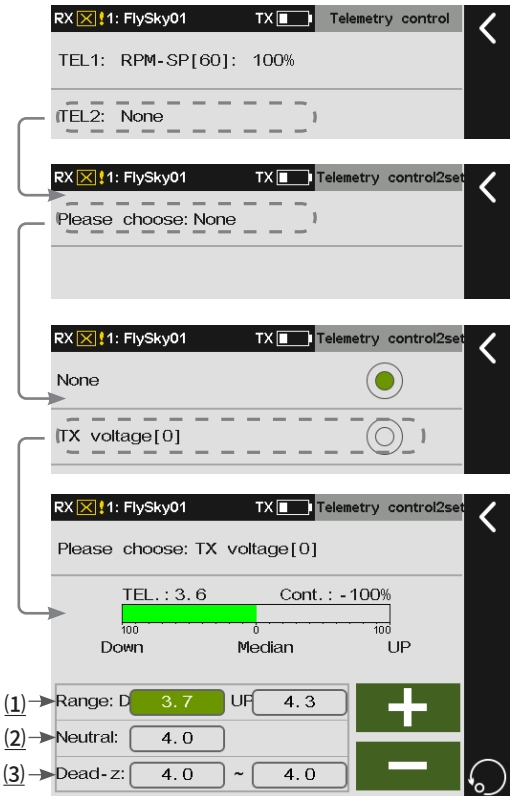

(1) **D**: The sensor data set here will be converted to the control value -100%; **UP**: the sensor data set here will be converted to the control value 100%.

After setting the data: **D** value ~ **UP** value corresponding to the control value -100% (min.) ~ 100% (max.)

(2) **Neutral**: According to the set UP and D end values, the neutral value is automatically generated, and the corresponding output control value is 0% (neutral value).

If the control area corresponding to the required data is not symmetrical, this value can be modified to set the required neutral value. The setting range will be limited to between the **UP** and **D** values.

(3) The default neutral has no Dead-zone. This item can be set if you want a small range of values fluctuating around the neutral (this will not affect the control value). Within this range, the output control value is always 0% (neutral value). The access to the Dead-zone setting is limited to both sides of the neutral and the middle of the **UP** and **D** end values.

Application Example:

Use the temperature sensor data to enable the heat sink through the telemetry function. When the temperature exceeds 30° C, the heat sink is enabled.

The preparation process is as follows: Install the temperature sensor and connect to the receiver > Install the servo



微信公众号



Bilibili



Website



Facebook

for controlling the heat sink and connect to the receiver > Connect the transmitter to the receiver.

At the transmitter side, it is necessary to use the program mixes function to achieve this. The steps are as follows:

1. Enter the **Program Mixes** interface and complete the following settings.
 - Select an auxiliary channel as Master, for example, auxiliary channel 18.
 - Set the servo channel that controls the heat sink, for example, auxiliary channel 5. Set it to Slave.
 - Click **Mix rate**. Select the line type and select the point at the middle position and set its rate to the appropriate value, for example, 100%.
 - Assign TEL1 as the switch to control the mix.
2. Enter the **Telemetry Control** interface.
 - Set TEL1 to the temperature sensor and set natural value to 30.

When the temperature exceeds 30° C, the TEL1 switch is ON and Mix 10 runs. When the temperature is lower than 30° C, the switch is OFF, the running stops, and the channel stops output.

The setting interface of Mix

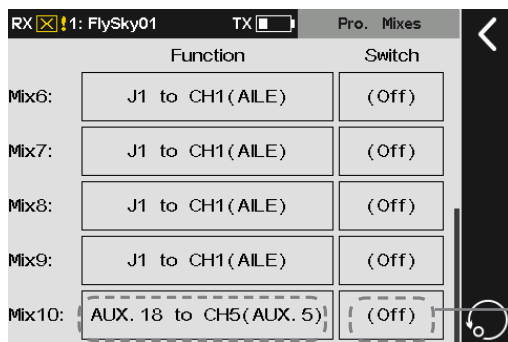

The setting interface of Telemetry Control

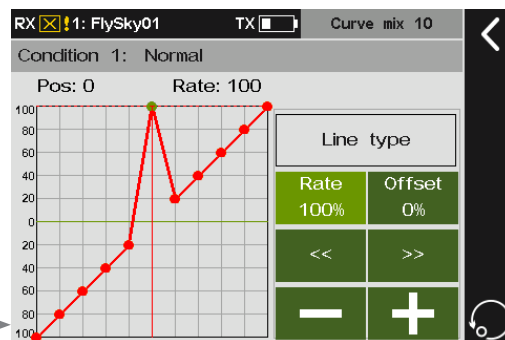
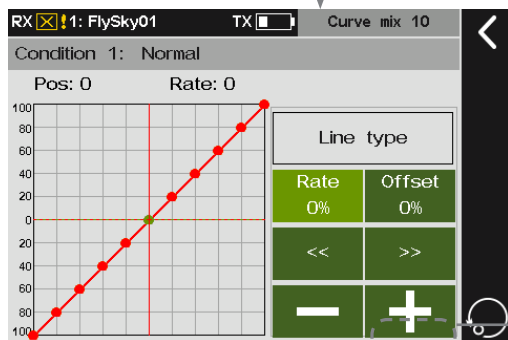
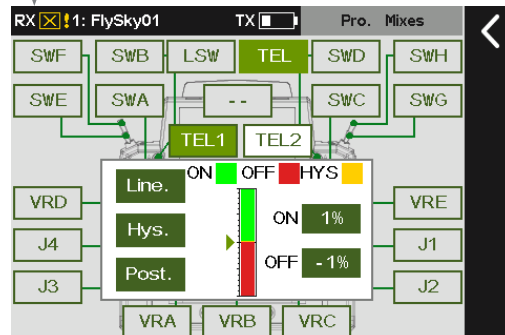
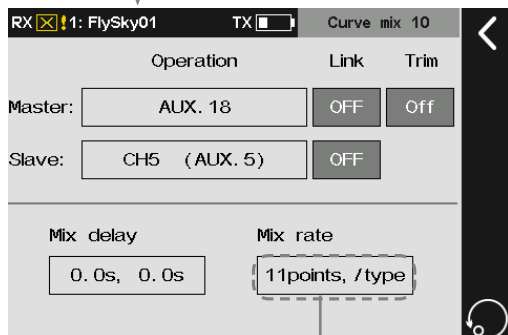
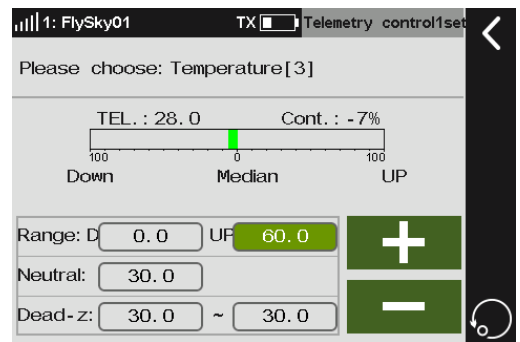

For different models, the telemetry function needs to be set accordingly to achieve specific control effects. To achieve better control effect, the joint debugging can be performed with using the functions such as Mixes, DR, and Function Assignment (AFR).



9. Helicopter Exclusive Function Setting

This chapter introduces the function settings of Helicopter mainly in default condition. After you can set the related model parameters via **Basic > Models**, then you can access **Model** to set the related functions of model via **Home1 > Model**.

Note: the function interface may different based on different model configurations.

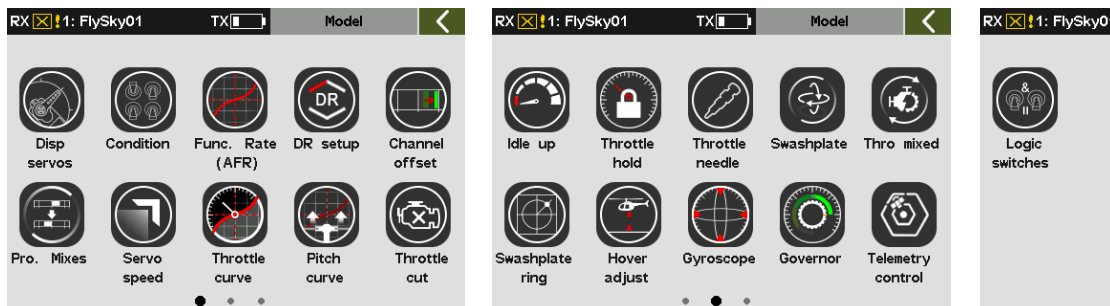

9.1 Display Servos

Please refer to **7.1 Display Servos** for this function.

9.2 Condition

Please refer to **8.2 Condition** for this function.

9.3 Func. Rate (AFR)

Please refer to **8.3 Func. Rate (AFR)** for this function.

9.4 DR Setup

Please refer to **8.4 DR setup** for this function.

9.5 Channel Offset

Please refer to **8.5 Channel offset** for this function.

9.6 Pro. Mixes

Please refer to **8.6 Pro. Mixes** for this function.

9.7 Servo Speed

Please refer to **8.7 Servo speed** for this function.



微信公众号



Bilibili



Website



Facebook

9.8 Throttle Curve

Please refer to **8.8 Throttle Curve** for this function.

9.9 Pitch Curve

In the current condition, adjust the motion curve of the helicopter's pitch to match the throttle output to achieve the best flight status. To set in another condition, you need to switch the condition first. Different output rate can be obtained through multi-point linear settings (up to 11 points).

Function setup:

Note: For the setting of **Rate/Offset**, refer to the description in **Throttle curve** above. For the Line type, please refer to the descriptions in chapter 16.

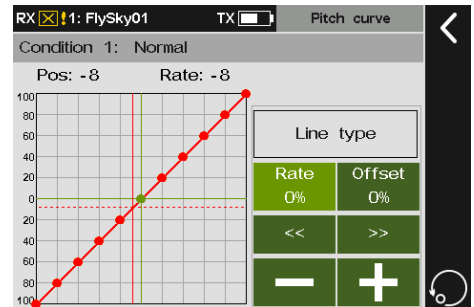

9.10 Throttle Cut

Please refer to **8.9 Throttle Cut** for this function.

9.11 Idle Up

Please refer to **8.10 Idle Up** for this function.

9.12 Throttle Hold

Quickly locking the throttle channel output value at a preset value by one switch can assist in spin landing, or act as a throttle lock switch to lock the throttle position in a safe place during commissioning. This function is not valid when the throttle cut switch is on. When the throttle hold is on, the mixes of the throttle from other functions is invalid. The throttle function is output after channel operations (Travel, Range, Normal and Reverse and channel delay) with the set hold values. The throttle function's mixes on other functions is also brought into operation using the value.

Function setup:

1. Tap **Throttle hold** to enter the setting interface.
2. Click **+** or **-** to set an appropriate value.
3. Click **Ⓞ** to set the switch to enable/disable the function.

Note: For settings of switch, refer to the descriptions in chapter 16.

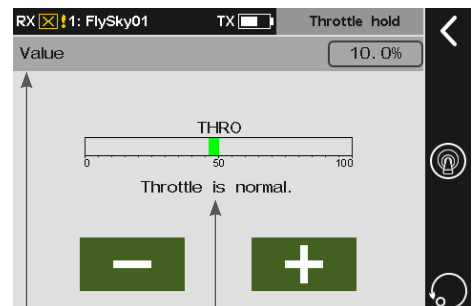

(1)

(2)

(1) Displays the value of the throttle hold when the throttle hold function enables.

(2) "Throttle is normal!" indicates the throttle hold function is disabled and the throttle status is normal. If the throttle hold function is enabled, the prompt changes to "Throttle held!" in red.



9.13 Throttle Needle

Please refer to **8.11 Throttle Needle** for this function.

9.14 Swashplate

Note: This function is derived from the original mixes and is only available on version 1.0.65 or later.

In the current condition, correspond the helicopter's ailerons, elevation and pitch to the mixes of the servos to achieve the best flight effect.

Function setup:

1. Tap **Swashplate mix** to enter the setting interface.
2. Tap item you want to set.
3. Click + or - to set the appropriate value. Click  to return to the previous interface.

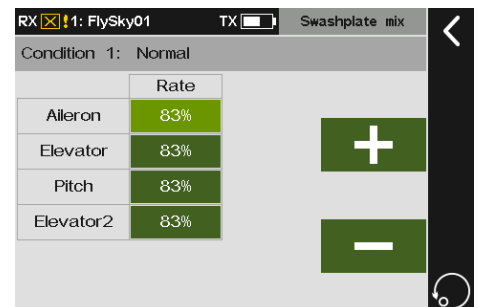

9.15 Thro Mixed

Note: This function is derived from the original mixes and is only available on version 1.0.65 or later.

In the current condition, set the helicopter's ailerons, elevation and rudder to the throttle's mixes rate. It is used to coordinate the flight movements of the helicopter in all directions (forward, backward, left and right) to compensate for the effect of swashplate manipulation on the engine when operating ailerons, elevation and rudder.

Function setup:

1. Tap **Thro mixed** to enter the setting interface.
2. Tap item you want to set.
3. Click + or - to set the appropriate value. Click  to return to the previous interface.

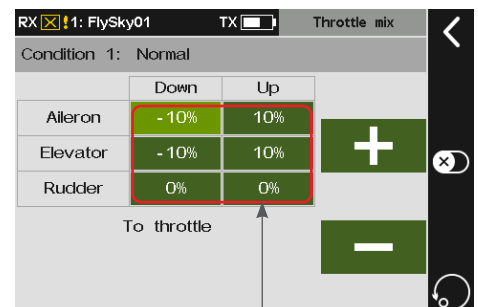

Tap the output rate item for throttle linked with the aileron, elevator or rudder.

9.16 Swashplate Ring

Limit the angle of swashplate movement. Change the helicopter's cycle pitch by adjusting the travel range of ailerons and elevation channels to control the helicopter's movements in all directions (forward, backward, left and right). If the ailerons and elevation travel range change too much, and the helicopter's swashplate angle exceeds the limit of the mechanical structure, the helicopter might be seriously damaged. Therefore, this function can protect the helicopter's mechanical structure.

This is a swashplate related advanced function. If you protect the mechanical structure by limiting the aileron and elevation movements via maximum travel range, the swashplate movements will be greatly restrained. But this function allows users to obtain more operation room while ensuring performance of the function.



微信公众号



Bilibili



Website



Facebook

Function setup:

1. Tap **Swashplate ring** to enter the setting interface.
2. Click **+** or **-** to set the appropriate value. Click **☒** to return to the previous interface.

Note: The green circle is the maximum range of the swashplate. The length of the line indicates the angle of the current swashplate. When the angle of the swashplate exceeds the radius, it will be limited to the radius value.

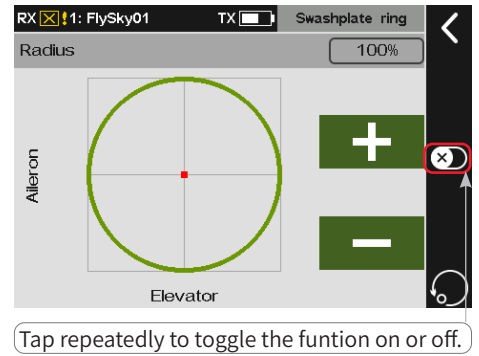

9.17 Hover Adjust

In the current condition, in order to allow the helicopter to hove easily by adjusting the rate of **Throttle** and **Pitch**. To set in another condition, you need to switch the condition first.

Function setup:

1. Tap **Hover adjust** to enter the setting interface.
2. Tap the function you want to set.
3. Click **+** or **-** to set the appropriate value.
4. Click **Ⓢ** to enter, and click **Throttle control** to enter the control assign interface. Afterwards, click a knob you want to set for throttle control or turn the physical knob on the transmitter. Then click **☒** to return to the previous interface.
5. Tap **Pitch control** to enter the control assign interface. Click a knob you want to set for throttle control or turn the physical knob on the transmitter.

Note: For the control of the function, you can only set a knob.

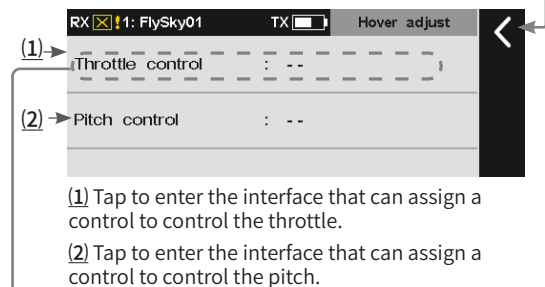
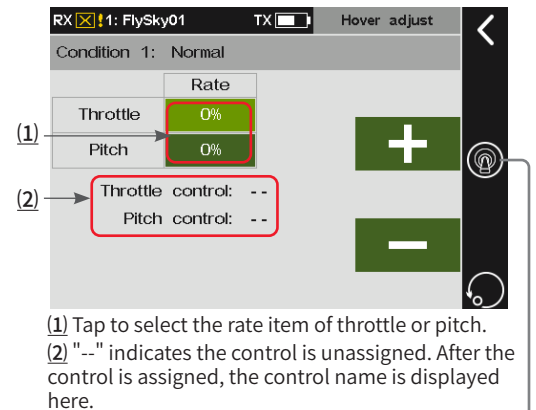

The switch assignment interface

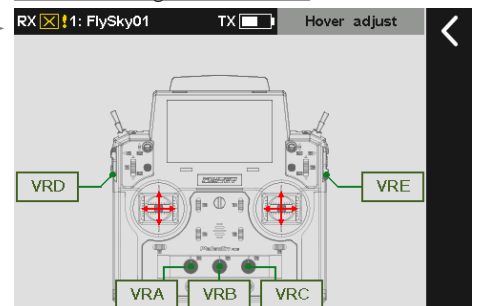



9.18 Gyroscope

Set the output value of gyroscope channel.

The system is preset with two gyroscope modes to switch between by a switch. You can switch between the modes to adjust the gyroscope channel output sensitivity. It is recommended to assign a two-position switch to switch between gyroscope 1 and gyroscope 2.

The function parameter setting is for the current condition. To set in another condition, you need to switch the condition first.

Function setup:

1. Tap **Gyroscope** to enter.
2. Tap  to enter, then assign a switch to control this function. For example, assign **SWB** in up position to turn on **Gyroscope1**.
3. Move the **SWB** switch to the up position and use **+** or **-** to change the sensitivity value of **Gyroscope1**.
4. Move the **SWB** switch to the down position and use **+** or **-** to change the sensitivity value of **Gyroscope2**. Click  to return to the previous interface.

Note: For settings of switch, refer to the descriptions in chapter 16.

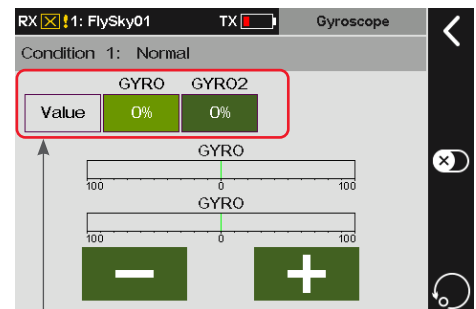

The sensitivity value of the gyroscope displays in numerical form.

9.19 Governor

Set the output value of **Governor** channel to adjust the RPM of the helicopter propeller to make the helicopter fly more stable. The function parameter setting is for the current condition. To set in another condition, you need to switch the condition first.

Function setup:

1. Tap **Governor** to enter the setting interface.
2. Click **+** or **-** to set the appropriate value. Click  to return to the previous interface.

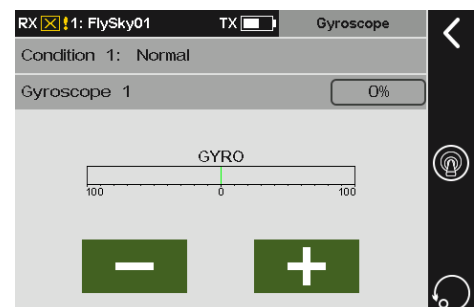

9.20 Logic Switches

Please refer to **8.20 Logic Switches** for this function.

9.21 Telemetry Control

Please refer to **8.22 Telemetry Control** for this function.



微信公众号



Bilibili



Website



Facebook

10. Multicopter Exclusive Function Setting

This chapter introduces the function settings of Multicopter mainly in default condition. After you can set the related model parameters via **Basic > Models**, then you can access **Model** to set the related functions of model via **Home1 > Model**.

Note: the function interface may different based on different model configurations.

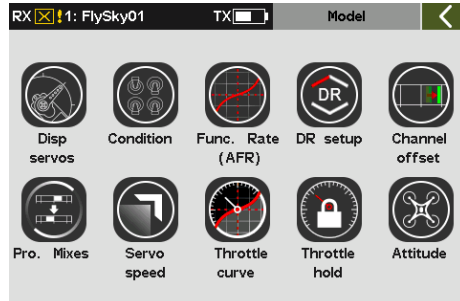

10.1 Display Servos

Please refer to **7.1 Display Servos** for this function.

10.2 Condition

Please refer to **8.2 Condition** for this function.

10.3 Func. Rate (AFR)

Please refer to **8.3 Func. Rate (AFR)** for this function.

10.4 DR Setup

Please refer to **8.4 DR Setup** for this function.

10.5 Channel Offset

Please refer to **8.5 Channel Offset** for this function.

10.6 Pro. Mixes

Please refer to **8.6 Pro. Mixes** for this function.

10.7 Servo Speed

Please refer to **8.7 Servo Speed** for this function.



10.8 Throttle Curve

Please refer to **8.8 Throttle Curve** for this function.

10.9 Throttle Hold

Please refer to **9.12 Throttle Hold** for this function.

10.10 Attitude

Please refer to **8.21 Attitude** for this function.



微信公众号



Bilibili



Website



Facebook

11. Car Exclusive Function Setting

This chapter introduces the function settings of Car mainly in default condition. After you can set the related model parameters via **Basic > Models**, then you can access **Model** to set the related functions of model via **Home1 > Model**.

The interface of car model with humvees



The interface of car model with track



11.1 Display Servos

Please refer to **7.1 Display Servos** for this function.

11.2 Condition

Please refer to **8.2 Condition** for this function.

11.3 Func. Rate (AFR)

Please refer to **8.3 Func. Rate (AFR)** for this function.

11.4 DR Setup

Please refer to **8.4 DR Setup** for this function.

11.5 Channel Offset

Please refer to **8.5 Channel Offset** for this function.

11.6 Pro. Mixes

Please refer to **8.6 Pro. Mixes** for this function.

11.7 Servo Speed

Please refer to **8.7 Servo Speed** for this function.



11.8 Throttle Curve

Please refer to **8.8 Throttle Curve** for this function.

11.9 ABS

This function can be used to set pulse braking, namely the brakes are released periodically when braking is triggered, to prevent skid, drift or under-turning due to locked wheels.

Note: This function is available for humvees model.

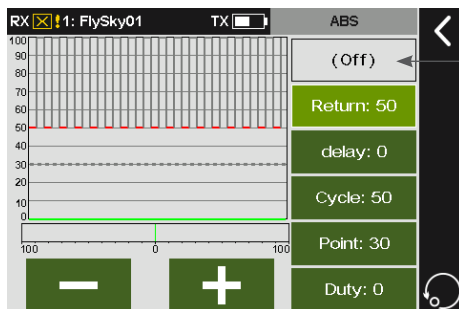

Tap to enter the switch assignment interface.

Note: For settings of switch, refer to the descriptions in chapter 16.

Return

To set the reduction of braking pressure at each pulse between 0% and 100%. The default value is 50%. When the value is set to 60%, the system will reduce the braking pressure by 60% from each pulse in real-time when braking is triggered.

Function setup:

1. Tap **Return** to enter the setting interface.
2. Click **+** or **-** to set the appropriate value.
Click to return to the previous interface.

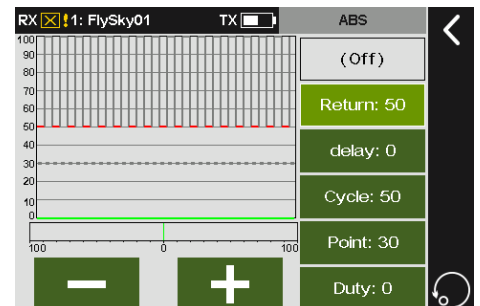

Delay

To set the time from trigger the pulse brake to actually pulse brake between 0% to 100%. The default value is 0%. The higher the value, the slower the pulse brake function will take effect. When the value is set to 0%, there is no delay, i.e. the pulse brake function takes effect immediately when the brake is triggered. When the value is set to 100%, the delay is 2S.

Function setup:

1. Tap **Delay** to enter the setting interface.
2. Click **+** or **-** to set the appropriate value.
Click to return to the previous interface.

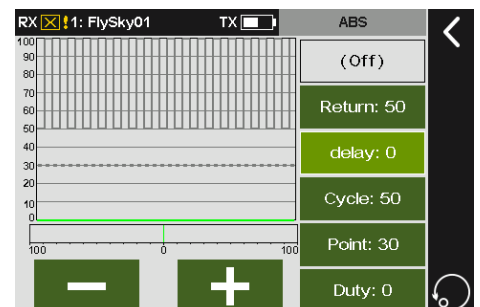

微信公众号



Bilibili



Website



Facebook

Cycle

It is used to set the interval between pulses. The setting range is 20% to 100%. The default value is 50%. The larger the value, the longer the interval time between pulses. The value 100% indicates the interval is 0.5S.

Function setup:

1. Tap **Cycle** to enter the setting interface.
2. Click **+** or **-** to set the appropriate value. Click  to return to the previous interface.

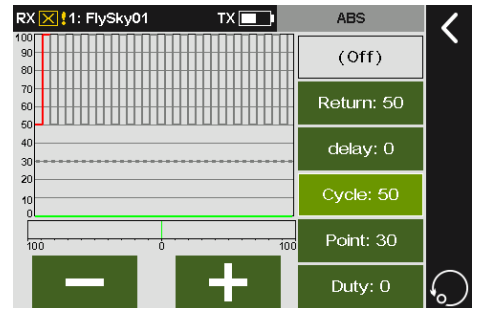

Point

It is used to set the start position of pulse brake function. The setting range is 20% to 100%. The default value is 30%. The higher the value, the closer the stick position that triggers the pulse brake function is to the full brake position. 0%-100% is the entire travel movement amount of the throttle trigger.

Function setup:

1. Tap **Cycle** to enter the setting interface.
2. Click **+** or **-** to set the appropriate value. Click  to return to the previous interface.

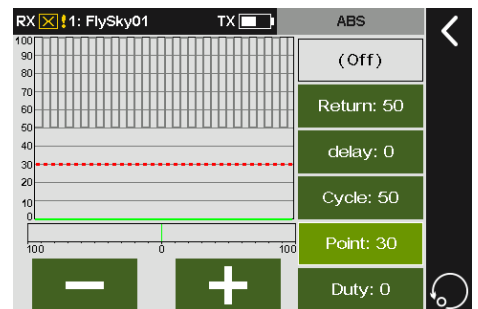

Duty

To set the braking - release cycle length in pulse braking between -4 and +4. Default: 0. When the value is changed, the peak and trough lengths of the brake pulse's square wave change accordingly. You can adjust the ratio between braking and release. The rate is 1:1 when the cycle length is set to "0". The rate is 1:2 when the cycle length is set to "1". And the rate is 2:1 when the cycle length is set to "-1".

Function setup:

1. Tap **Cycle** to enter the setting interface.
2. Click **+** or **-** to set the appropriate value. Click  to return to the previous interface.

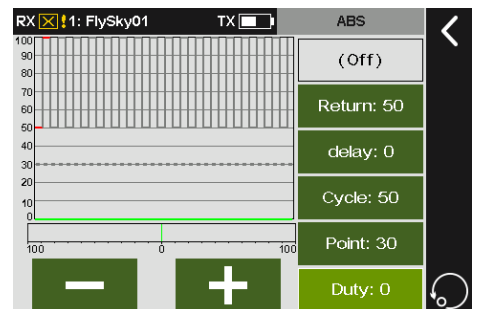

11.10 Track Mixing

Note: This function is available for version 1.0.65 or later.

When this function is enabled, the control corresponding to the left track can control the changes of the left and right tracks in same rate to move forward and backward, and the control corresponding to the right track can control the changes of the left and right tracks in reverse-rate to turn left and right. The forward, backward, left and right rates can be set in the function menu.

Note: This function is available for track model.

Function setup:

1. Tap **Delay** to enter the setting interface.
2. Tap the function item you want to set. The currently selected function item is highlighted in light green.
3. Click **+** or **-** to set an appropriate value. Tap  to return to the previous interface.

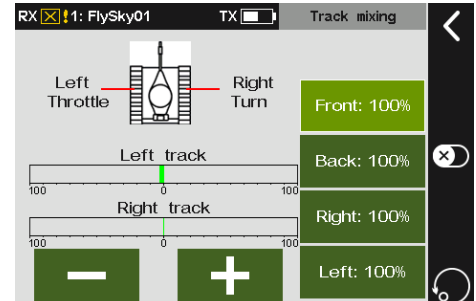

11.11 Logic Switches

Please refer to **8.20 Logic Switches** for this function.

11.12 Telemetry Control

Please refer to **8.22 Telemetry Control** for this function.



微信公众号



Bilibili



Website



Facebook

12. Boat Exclusive Function Setting

Note: This function is available for version 1.0.65 or later.

This chapter introduces the function settings of **Boat** mainly in default condition. After you can set the related model parameters via **Basic > Models**, then you can access **Model** to set the related functions of model via **Home1 > Model**.

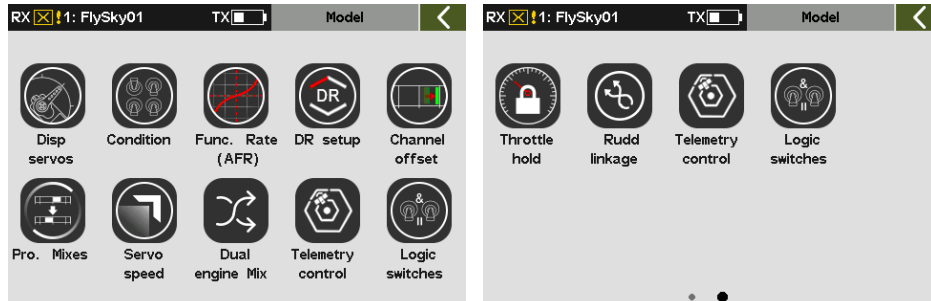

12.1 Display servos

Please refer to **7.1 Display Servos** for this function.

12.2 Condition

Please refer to **8.2 Condition** for this function.

12.3 Func. Rate (AFR)

Please refer to **8.3 Func. Rate (AFR)** for this function.

12.4 DR Setup

Please refer to **8.4 DR Setup** for this function.

12.5 Channel Offset

Please refer to **8.5 Channel Offset** for this function.

12.6 Pro. Mixes

Please refer to **8.6 Pro. Mixes** for this function.

12.7 Servo Speed

Please refer to **8.7 Servo Speed** for this function.

12.8 Throttle Curve

Please refer to **8.8 Throttle Curve** for this function.



12.9 Logic Switches



Please refer to **8.20 Logic Switches** for this function.

12.10 Dual Engine Mix

Note: This function is available for version 1.0.70 or later.

This function enables when the ship model has dual engines without rudders. By dual engine mix function to control the forward/backward or left/right of the ship.

Function setup:

1. Tap **Dual engine Mix**.
2. Tap the function item you want to set.
The currently selected function item is highlighted in light green.
3. Click + or - to set an appropriate value.
4. Tap  to enable the function, then click  to return to the previous interface.

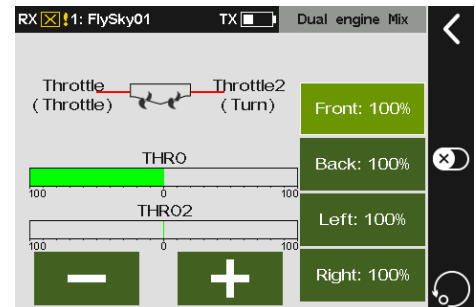



12.11 Rudd Linkage

Note: This function is available for version 1.0.70 or later.

This function enables when the ship model has dual engines with two rudders to realize the rudder linkage output. The function parameter setting is for the current condition. To set in another condition, you need to switch the condition first.

Function setup:

1. Tap **Rudd Linkage**.
2. Tap the function item you want to set.
The currently selected function item is highlighted in light green.
3. Click + or - to set an appropriate value.
4. Tap  to enable the function, then click  to return to the previous interface.

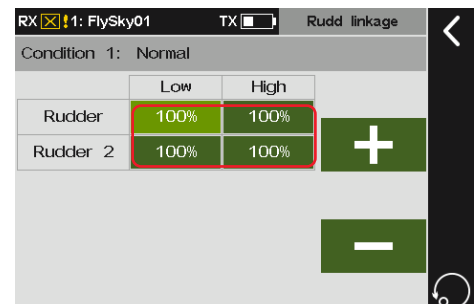

12.12 Telemetry Control

Please refer to **8.22 Telemetry Control** for this function.

12.13 Throttle Hold

Please refer to **9.13 Throttle Hold** for this function.

12.14 Throttle Needle

Please refer to **8.11 Throttle Needle** for this function.

12.15 Throttle Curve

Please refer to **8.8 Throttle Curve** for this function.



微信公众号



Bilibili



Website



Facebook

13. Robot Exclusive Function Setting

Note: This function is available for version 1.0.65 or later.

This chapter introduces the function settings of **Robot** mainly in default condition. After you can set the related model parameters via **Basic > Models**, then you can access **Model** to set the related functions of model via **Home1 > Model**.

The interface of robot model with humvees

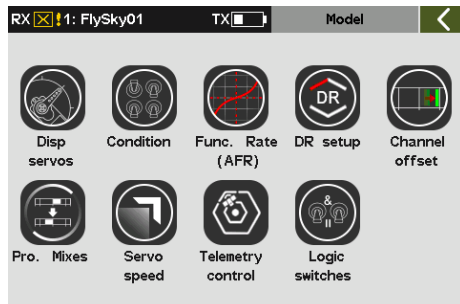

The interface of robot model with track

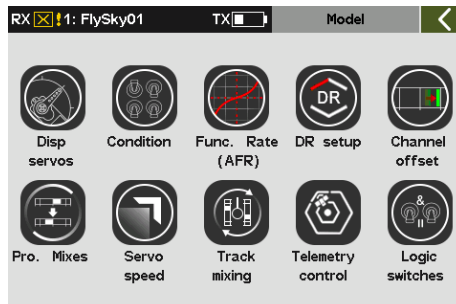

13.1 Display Servos

Please refer to **7.1 Display Servos** for this function.

13.2 Condition

Please refer to **8.2 Condition** for this function.

13.3 Func. Rate (AFR)

Please refer to **8.3 Func. Rate (AFR)** for this function.

13.4 DR Setup

Please refer to **8.4 DR Setup** for this function.

13.5 Channel Offset

Please refer to **8.5 Channel Offset** for this function.

13.6 Pro. Mixes

Please refer to **8.6 Pro. Mixes** for this function.

13.7 Servo Speed

Please refer to **8.7 Servo Speed** for this function.

13.8 Telemetry Control

Please refer to **8.22 Telemetry Control** for this function.



13.9 Track Mixing

Please refer to **11.10 Track Mixing** for this function.

13.10 Logic Switches

Please refer to **8.20 Logic Switches** for this function.



微信公众号



Bilibili



Website



Facebook

14. System Setting

The system menu content is mainly used to set various system functions of the transmitter, such as screen settings, sound settings, and so on. Access System functions via **Home1 > System**.

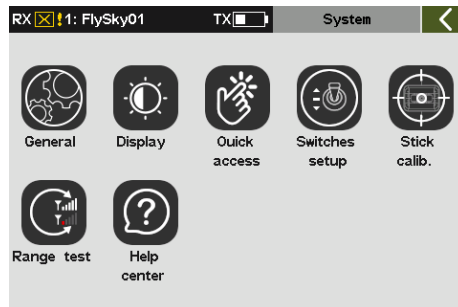

14.1 General Function Setting

This section describes the setting on the General function. To access the General function via **Home1 > System > General**.

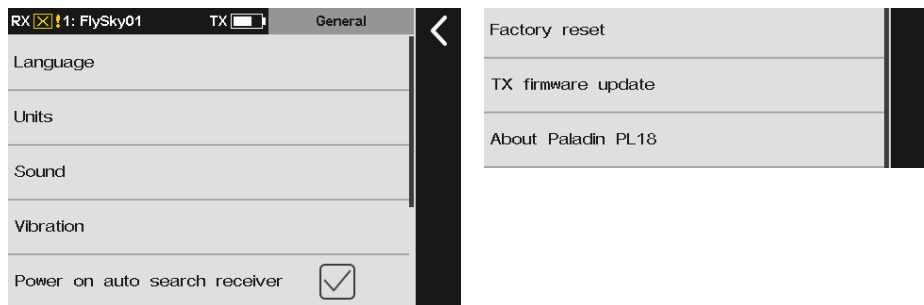

14.1.1 Language Setting

You can choose the language from **English** and **Chinese**.

Function setup:

1. Tap **Language** to enter.
2. Tap an appropriate language. Then click  to return.

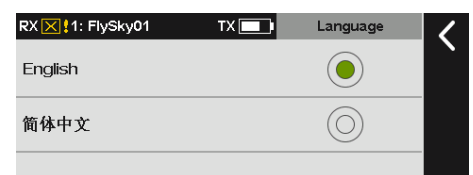

14.1.2 Units

Choose what units to use for length and temperature.

Length can select metric and imperial system. The default is **Metric**. **Temperature** can be selected in **Celsius** and **Fahrenheit**. The default is **Celsius**.

Function setup:

Tap **Units** to enter and click an appropriate item. Then click  to return.

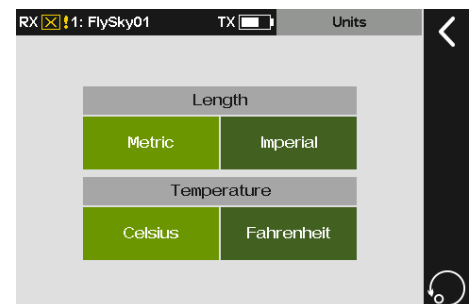

14.1.3 Sound

Turn on or off system sound, alarm sound, or ON/OFF sound.

Function setup:

1. Tap **Sound** to enter.
2. Tap an appropriate item you want to set. "√" appears and indicates to turn on the sound.
3. Click +/- to change the volume of the sound. Then click to return.

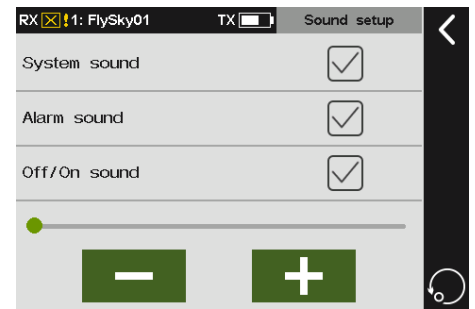

14.1.4 Vibration

This function enables or disables vibration for various actions.

Function setup:

1. Tap **Vibration** to enter.
2. Tap an appropriate item you want to set.
3. Click the item you desired. Then click to return.

Note: This function is disabled by default. Click located in the middle of the right side of the interface to turn on, and this function will enable.

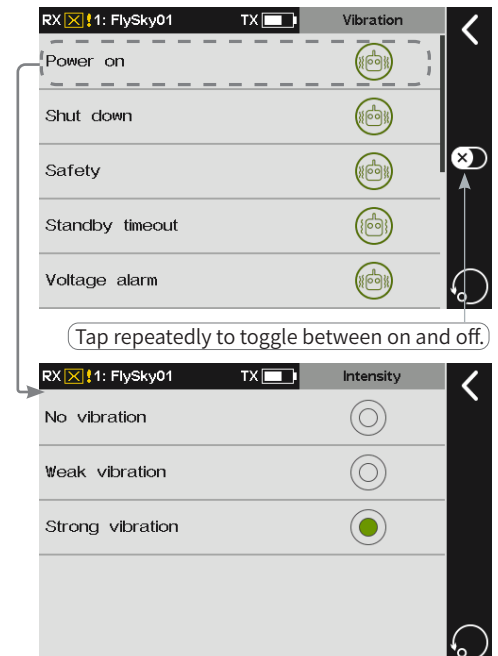

14.1.5 Auto Search For Receiver

Note: This function is applicable for version 1.0.65 or later.

When the **Power on auto search receiver** is checked and the RF is turned on. You can make settings to automatically switch to the model corresponding to the currently powered on receiver. It is same as the **Searching for the receiver** function of **Model Select**.

Function setup:

Tap **Power on auto search receiver**, "√" appears and indicates to turn on it.

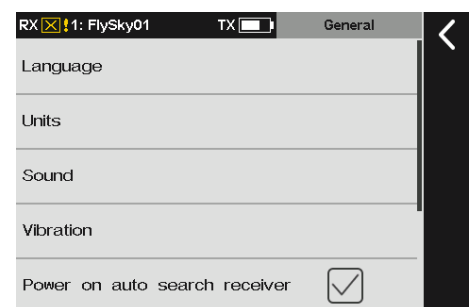

微信公众号



Bilibili



Website



Facebook

14.1.6 Factory Reset

Resets the transmitter to its factory default state. All data including all model data and system settings will be reset.

Function setup:

Tap **Factory reset** and click **Yes** on the pop-up screen.

Then the transmitter will reset to its factory default mode.

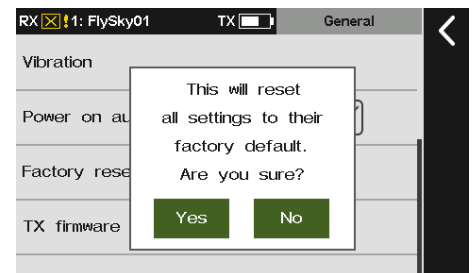

14.1.7 Updating Transmitter Firmware

Updates the transmitters firmware. In case of updating the firmware of the transmitter, use this function to put the transmitter to enter updating mode first, then upgrade the transmitter's firmware.

 WARNING	<ul style="list-style-type: none">• Use the micro USB cable shipped with the transmitter.• Do not unplug the micro USB cable while the firmware is updating.
--	---

Function setup:

1. Download the latest firmware, then open it.
2. Connect the PC and PL18 transmitter via micro USB cable.
3. Tap **TX firmware update** via **System > General**, a pop-up screen appears. Click **Yes** to put the transmitter into updating mode.
4. The updating interface in the PC is shown on the right, for your reference only. Click **Update** to start.
5. The transmitter will power on again when the updating process is completed. Then remove the USB cable and close the firmware.

Notes:

1. The firmware of the transmitter can also be updated by FlyskyAssistant. In such case, make sure the transmitter is connected to the PC only.
2. If more than one firmware are opened at the same time, only one firmware can be recognized by the transmitter.

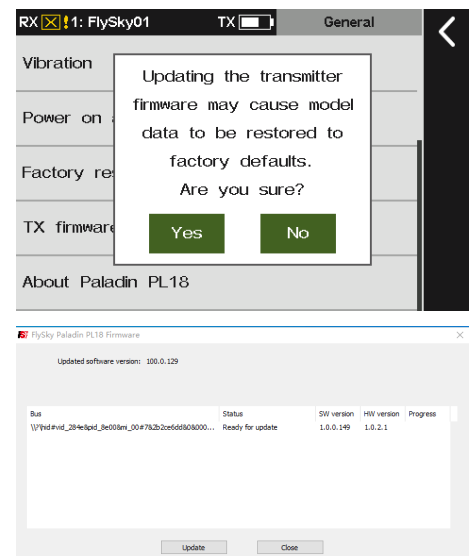

14.1.8 About Paladin PL18

To view system information, including product name, software version, software release date, and hardware version.

Function setup:

Tap **About Paladin PL18** to view.

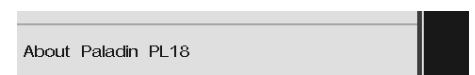

14.2 Display Setting

This section describes the setting on the Display function. To access the Display function via Home1 > System > Display.

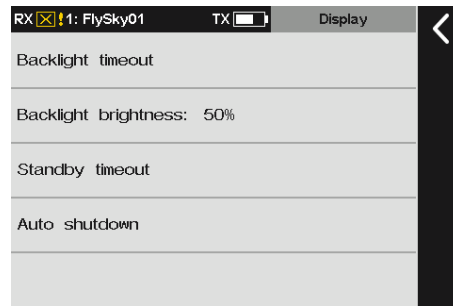

14.2.1 Backlight Timeout

Changes how long the screen takes to turn off when not in use. The default is 30 seconds. You can set an appropriate time as your desired.

Function setup:

1. Tap **Backlight timeout** to enter.
2. Tap an appropriate item you want to set. Then click to return.

Note: Leaving the screen on for longer will use more power and as such may lead to reduced battery time.



14.2.2 Backlight Brightness

Adjusts the brightness of the screens backlight.

Function setup:

1. Tap **Backlight brightness** to enter.
2. Click +/- to change to an appropriate value. Then click to return.

Note: Turning the brightness up will use more power and as such will lead to reduced battery life.

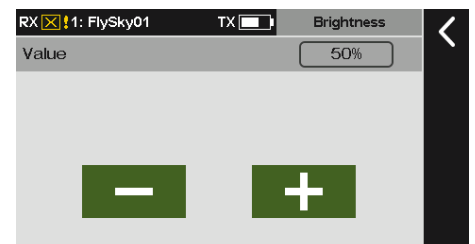

14.2.3 Standby Timeout

Sets the time of the Standby timeout.

Function setup:

1. Tap **Standby timeout** to enter.
2. Tap an appropriate item you want to set. If you do not want to set it, click **None**. Then click to return.



微信公众号



Bilibili



Website



Facebook

14.2.4 Autoshut Down

To enable/disable the function which turns the transmitter off if not connected to a receiver and is not in use.

Function setup:

1. Tap **Auto shutdown** to enter.
2. Tap an appropriate item you want to set. If you do not want to set it, click **None**. Then click to return.



14.3 Qucik Access Setting

This function is used to set up the up, down, left and right quick sliding screen functions of the main interface. Users can customize the sliding screen interface according to their needs. The default setting is **None**.

Function setup:

1. Tap **Qucik access** and click the item you want to set to enter the next interface.
2. Tap an appropriate item you want to set. Then click to return.

Note: When you slide the main interface, please slide from the area as close to the borders of the main interface as possible. For example, slide from the right slide of the main interface in the figure.

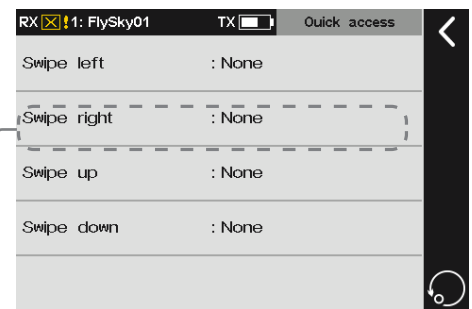

After setting, interface for sliding right on the home page to display the timer:

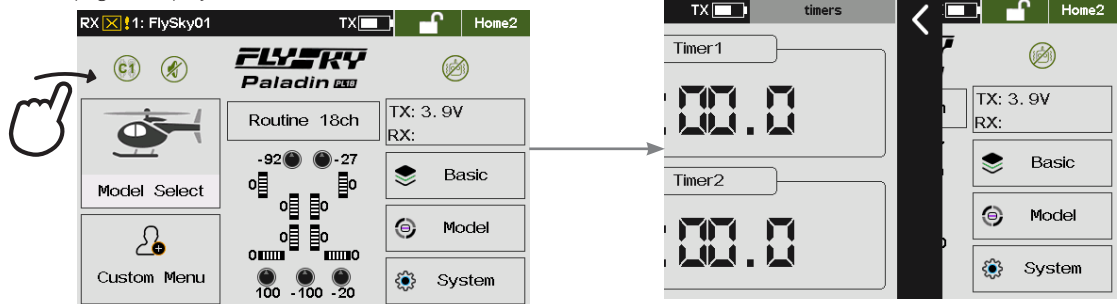

14.4 Position-switch Setup

This function is used to set up the whether it will be a two-position switch or a three-position switch for SWE, SWF, SWG and SWH, If you want to replace the switch in these four switches.

Function setup:

1. Tap **Switches setup** to enter.
2. Tap the switch you want to set repeatedly to toggle between **3 levels** or **2 levels**. Then click  to return.



14.5 Stick Calibration

Used to calibrate the sticks(J1-J4) and the Kobs(VRA-VRE).

Function setup:

1. Tap **Stick Calib.** to enter the calibration interface.
Place the sticks and knobs marked on the interface in the central position.
2. After you click **Calibrate**, the system will pop up "Please move the sticks and knobs to the maximum and minimum travel".
3. Push all the sticks **J1-J4** along the direction of left/right/forward/backward to the maximum or minimum travel.
4. Turn all knobs **VRA-VRE** in the direction of clockwise/counterclockwise to maximum or minimum travel.
5. After turning the sticks and the knobs to the maximum and minimum travel respectively, click  to return.
 - If the "Calibration succeeds" pop-up screen appears, click **Exit**.
 - If the calibration fails, tap **Yes** to recalibrate. To exit the calibration interface automatically, tap **No**.

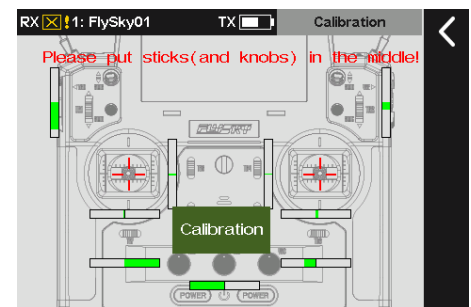

14.6 Range Test

Used to test whether wireless communication between the transmitter and the receiver is normal and the ambient radio interference.

As the actual remote control distance between transmitter and receiver is far away, it is difficult to make the transmitter and receiver apart to several hundred meters to verify whether the RF module works normally. By using this function, the theoretical remote control distance can be reduced to 30-40 meters. When this function is enabled, it can test whether the transmitter and receiver are normal in a close distance, so as to save the test time.

Note: This function is only applicable to RF FRM301.

Function setup:

1. Make sure the transmitter and the receiver are bound normally.
2. Enter the **Range Test** interface and pull down the **SWH** button
3. One person stands in place with the model in hand,



微信公众号



Bilibili



Website



Facebook

and the other person holds the transmitter and gradually moves away to 30-40 meters and walks around with this distance as a radius centered on this model.

4. Make sure that the transmitter antenna is not blocked. The receiver antenna is placed at 90 degrees, and there is no interference between the transmitter and the receiver in the open area.
5. Observe the signal strength of the transmitter. If the signal strength is high and stable, it means that the radio frequency of this system works normally.

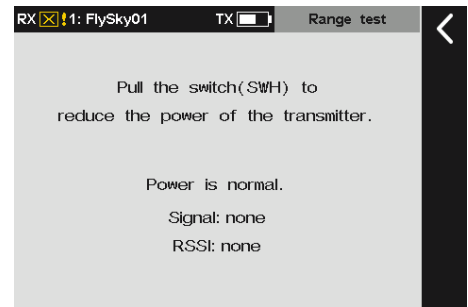

14.7 Hlep Center

Note: This function is applicable for version 1.0.65 or later.

To obtain the user manual via this function. Users can contact us through social accounts listed on the interface.

Function setup:

1. Tap **Help center** to enter.
2. Tap the item you want to view, then the corresponding QR code will be displayed.
3. Scan the QR code to obtain the related information. Then click  to return to the previous interface.

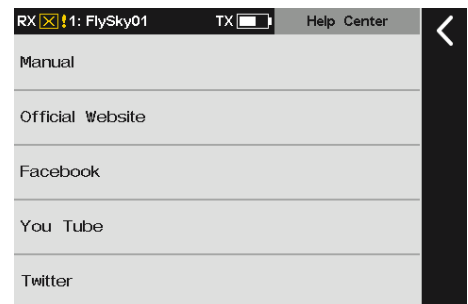

15. Custom Menu Setting

This function allows you to customize the menu item sorting and hiding in the menu area. You can prioritize to list some frequently used function compared to those seldom used function, and hide some less used function items. By default, all function items are visible.

Function setup:

1. Tap **Edit menu**.
2. Tap the item you want to move, namely the item in highlight color is selected. Click **Move up** or **Move down** to change its order in the list.

Note: There is a function box on the right. If you select the checkbox, it means that the function item is displayed. If you do not select it, it means that the function item is hidden.

For example, move **Func. assign** to the second position:

1. Tap **Edit menu**.
2. Click **Func. assign**.
3. Click **Move down** once to finish.

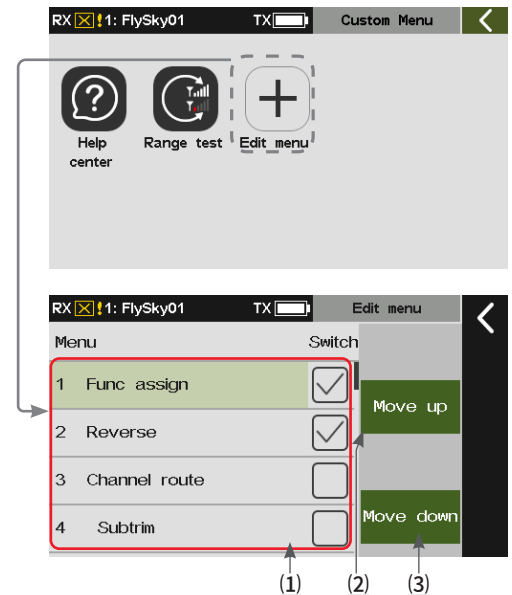

(1) Function items area, tap it, "√" appears and it means that the function is displayed. "√" does not appear, it means that the function is hidden.

(2) Tap to move the selected item up.

(3) Tap to move the selected item down.



微信公众号



Bilibili



Website



Facebook

16. Same Common Operation Items Setting

This section describes the setting steps for some common operation items in the function settings.

16.1 Switch assignment Note: This function is applicable for version 1.0.65 or later.

How to set a switch which is for certain functions.

16.1.1 Normal ON/OFF Switch Setting

If the function does not need switch control, it can be set to "--" with the state being set to **Open** or **Close**. At this time, the function is disabled or enabled. In the execution of the trainer function, the switching state of the student remote control can be set through this function.

Function setup:

1. Enter the switch assignment interface.
2. Click **Open** to toggle between **Open** or **Close**.
3. Click -- to cancel the switch if a physical control on the transmitter is assigned.

Note: Action switch does not support the setting of Normal ON or Normal OFF. On such switch assignment interface, you can tap -- to only disable the switch assignment function, for example, clear polarity of sensor, enable/disable timer switch, and so on.

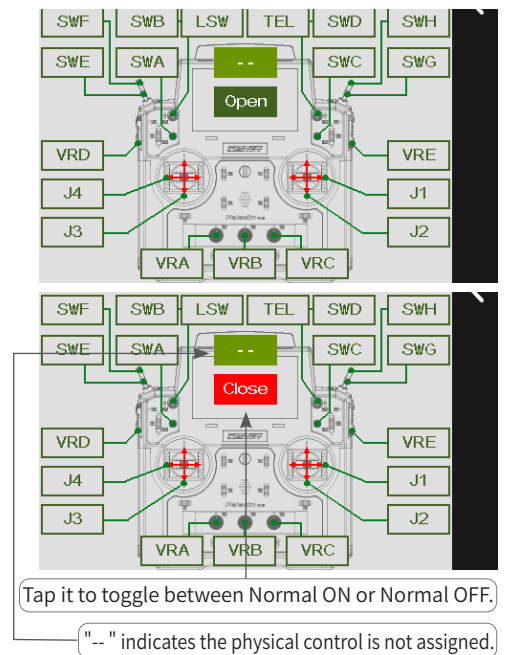

16.1.2 Position-switch Setting

For two-position and three-position switches, you can set any position to **Open** or **Close**.

Function setup:

1. Enter the switch assignment interface.
2. Toggle the corresponding physical control on the transmitter or tap the control name in the interface to select the control, for example, **SWD**.
3. Tap **Open** or **Close** of any gear position to set the appropriate on or off status of this position.

Notes:

1. Except for **SWH**, all switches starting with "SW" are for position switches. **SWH** is a spring return switch. It is recommended to set other position switches as the **ON** or **OFF** switch for functions.
2. The switch assignment operations for the Timer and Sensor are the same as above. However, this switch function is "Action Switch". That is, the action switching from "OFF" position to "ON" position is a valid action, and this function is a one-time switch.

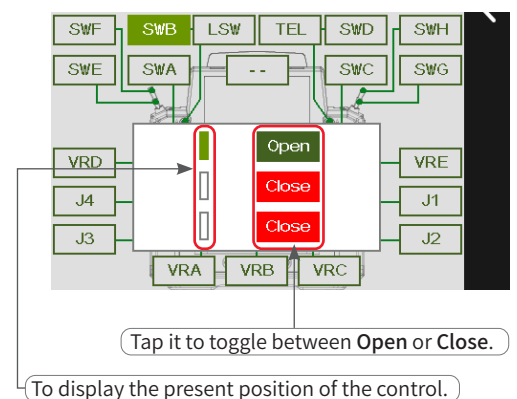

16.1.3 Continuous Switch Setting

For continuous controls such as stick or knob, the ON or OFF position can be set more flexibly according to different setting types.

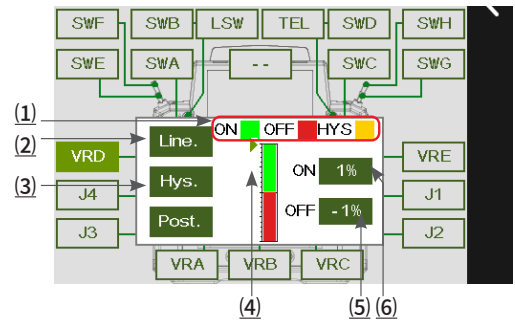

- (1) To display the switch state in this area. The green means ON, the red means OFF, the yellow means HYS(hysteretic).
- (2) Tap repeatedly to toggle between Line.(linear) and Symm.(symmetric).
- (3) Tap repeatedly to toggle between Hys. (Hysteresis) and Box.
- (4) Triangle means the present position of the control.
- (5) To show the position value of OFF. Tap to set the present position of the control to OFF.
- (6) To show the position value of ON. Tap to set the present position of the control to ON.

Linear/Symmetric Mode

Line. means the setting of ON or OFF position separately for the whole control travel. Symmetric means the setting of ON or OFF position symmetrically for the upper part or the lower part with the neutral point as the reference. You can switch the ON or OFF position by Posit. (Positive)or Reve.(Reverse).

Function setup:

1. Enter the switch assignment interface.
2. Toggle the corresponding physical control on the transmitter or tap the control name in the interface to select the control, e.g., VRD.
3. Switch the type mode by tapping Line.
4. Turn the VRD to a suitable position, and click ON in the green function box on the right to set this position to ON.
5. Turn the VRD to another suitable position, and click OFF in the green function box on the right to set this position to OFF.
6. Click Posit. to reverse the switch status.

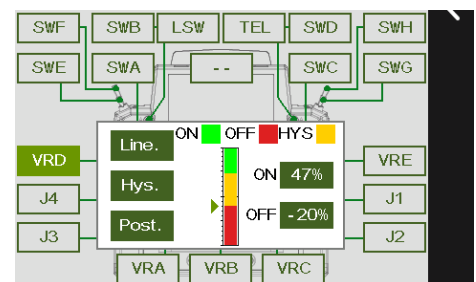
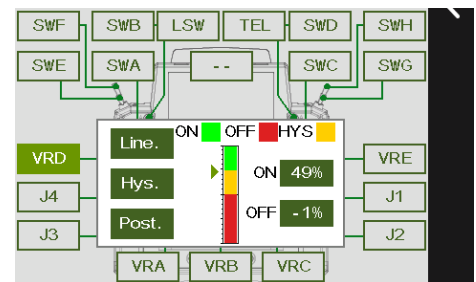

Hysteresis/Box Mode

Hys. means the setting of border for ON or OFF only. You can set the hysteresis interval yellow for the border. When the control position is in the hysteresis interval, the previous state is kept. Box has no hysteresis interval. You can set 2 border values for on/off area. When the switch is outside this area, the switch state is opposite to the state inside this area. You can switch the ON or OFF position by Posit. or Reve.

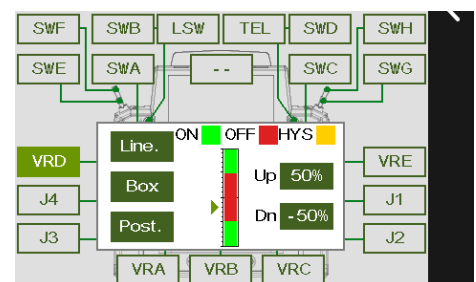

微信公众号



Bilibili



Website



Facebook

Function setup:

1. Enter the switch assignment interface.
2. Toggle the corresponding physical control on the transmitter or tap the control name in the interface to select the control, e.g., **VRD**.
3. Switch the type mode by tapping **HYS**.
4. Turn the **VRD** to a suitable position, and tap **ON/UP** in the green function box on the right to set this position to **ON/UP**.
5. Turn the **VRD** to another suitable position, and tap **OFF/DN(Down)** in the green function box on the right to set this position to **OFF/DN**.
6. Click **Posit.** to reverse the switch status.

16.1.4 Logic Switch Setting

Provide the interface for selecting logic switches. Users can preview the corresponding component switches and logical relations of logic switches, and can click the preview box to enter the logical switch setting interface to reset the logical switches.

Function setup:

1. Enter the switch assignment interface.
2. Click **LSW** and a pop-up screen appears. Click the logic switch you want to set, then tap the area to enter the setting interface. Then you can set a new logic switch.

Note: The on/off of Logic switch is to enable or disable a function.

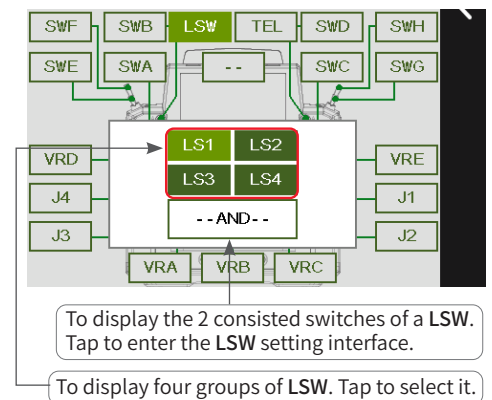

16.2 Linear Setting

Note: This function is applicable for version 1.0.65 or later.

This section describes the linear settings of throttle curve and each mixes function. Such as **linear type** or **curve type** setting (**Throttle cut**, **Pitch curve**, **Throttle needle** and **Pro. mixes**).

Function setup:

1. Click **Linear type** to enter the setting interface.
2. Click the appropriate linear type and points. Then click **Return**.
 - Click **<</>>** to select the point. The current selected point is shown in green.
 - Click **+/-** to change the values of **Rate** and **Offset**.

Notes:

1. After the linear type changes, the linear parameters before the change are overwritten.
2. The line can be shifted along the Y axis by offset value set.

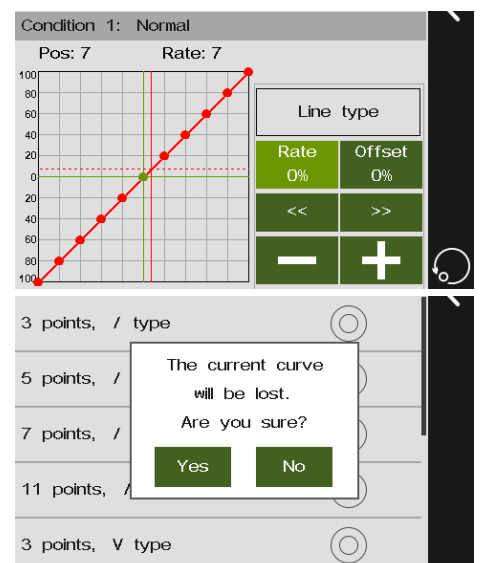

17. How Transmitter Output Functions Are Processed

This section contains the Paladin PL18 functional arithmetic logic content.

This figure shows how the system handles the transmitter output function and how the various configuration choices/settings affect the output function.

When you move a transmitter control, such as a stick or switch, the final output value of the channel will be calculated and output in the order shown according to the setup function: **Func. Rate (AFR)/DR setup** > **Set by function** > **Mixes** > **Reverse** > **Channel End** > **Channel Range** > **Set by channel**.

Notes:

1. The **Mixes** includes the function mixing such as **Aileron to Rudder** and **Programming mixes**. The operation result will be output via **Reverse**, **Channel End** which is superimposed with other operation results of the channel with the **Channel Range** operation, and **Set by channel** function operation.
2. When **Master of Programming mixes** is set to a function, **Slave** will be delayed if **Set by Function** is set for this function.
3. After the value of the trim control is calculated by **Trim Rate** and **Trim Mode**, then will be superimposed with other values of this channel, such as **Subtrim**, before **Channel Range** calculation.

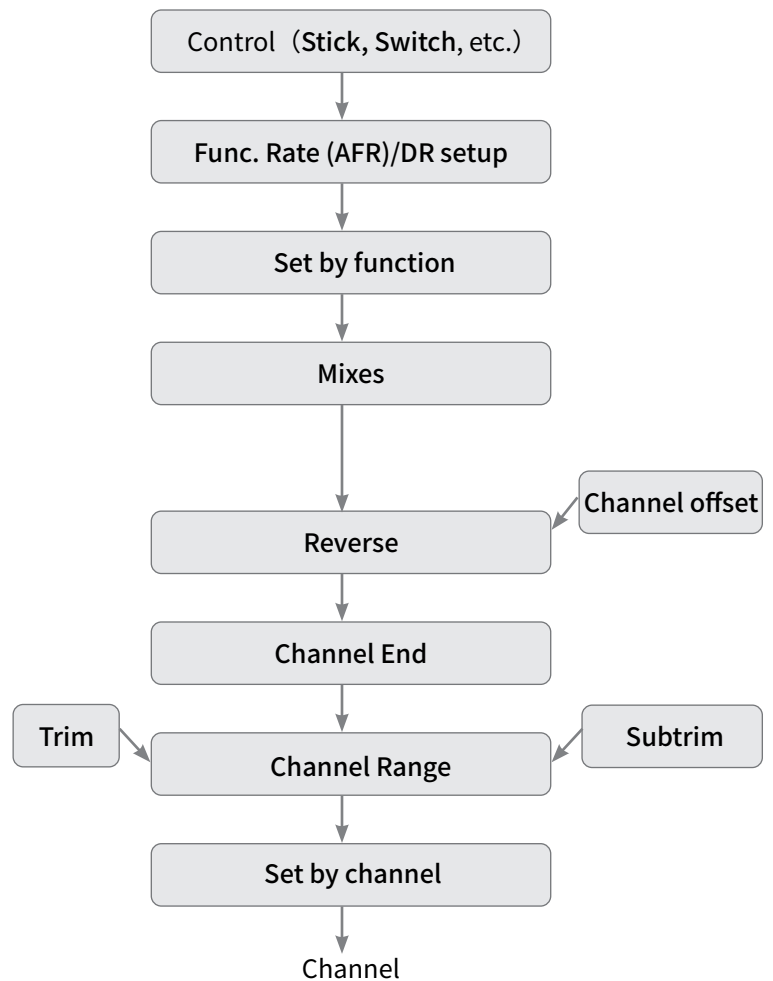

微信公众号



Bilibili



Website



Facebook

18. Product Specification

This section describes the specifications for Paladin PL18 transmitter.

Product Model	PL18
Product Name	Paladin
Number of Channels	18
Adaptable Models	Airplanes, helicopters, gliders, multicopters, cars, boats and robots.
RF	2.4GHz ISM
Maximum Power	< 20 dBm (e.i.r.p.) (EU)
2.4GHz Protocol	AFHDS 3
Distance	>3500m (Air distance)
Resolution	4096
Battery	Lipo Battery, 1S (3.7V) * 4300mAh (Built-in)
Charging Jack	Micro USB/Wireless Charging
Charging Time	4h@5V*2A/7h@5V*2A(Wireless charging)
Battery Life	>8h
Low Voltage Alarm	< 3.65V
Antenna Type	Two Antennas
Display	HVGA 3.5 TFT
Language	Chinese and English
Simulator	USB Simulator
Data Interface	Micro USB, BLUETOOTH, PHJACK(PPM)
Temperature Range	-10°C ~ +60°C
Humidity Range	20% ~ 95%
Online Update	Yes
Color	Black
Dimensions	214*86.5*192 mm
Weight	946g
Certification	CE, FCC ID:N4ZFT1800, RCM



19. Package Contents

The chapter contains the information related to package. Please contact the local dealer for detailed configuration due to different version of transmitter.

Number	Name	Quantity
1	PL18 Transmitter	1
2	Quick Start Guide	1
3	Ftr8B Receiver	1
4	Sunshade	1
5	Large Thickening Grip	1
6	PL18 stick	2
7	Micro USB cable	1
8	Switch Sets	2
9	Soft spring for adjusting elastic force of gimbal assembly	4
10	Hard spring for adjusting elastic force of gimbal assembly	4
11	Publicity Design Stickers	1
12	LOGO Stickers	1



微信公众号



Bilibili



Website



Facebook

20. Certifications

20.1 DoC

Hereby, [Flysky Technology co., ltd] declares that the Radio Equipment [Paladin(PL18),FT18] is in compliance with RED 2014/53/EU.

The full text of the EU DoC is available at the following internet address: www.flyskytech.com/info_detail/10.html

20.2 CE Warning

The antenna(s) used for this transmitter must be installed to provide a separation distance of at least 20 cm from all persons and must not be co-located or operating in conjunction with any other transmitter. End-users and installers must be provided with antenna installation instructions and transmitter operating conditions for satisfying RF exposure compliance.

20.3 FCC Statement

This equipment has been tested and found to comply with the limits for a Class B digital device pursuant to part 15 of the FCC rules. These limits are designed to provide reasonable protection against harmful interference in a residential installation. This equipment generates, uses and can radiate radio frequency energy and, if not installed and used in accordance with the instructions, may cause harmful interference to radio communications. However, there is no guarantee that interference will not occur in a particular installation. If this equipment does cause harmful interference to radio or television reception, which can be determined by turning the equipment off and on, the user is encouraged to try to correct the interference by one or more of the following measures:

- Reorient or relocate the receiving antenna.
- Increase the separation between the equipment and receiver.
- Connect the equipment into an outlet on a circuit different from that to which the receiver is connected.
- Consult the dealer or an experienced radio/TV technician for help.

To assure continued compliance, any changes or modifications not expressly approved by the party responsible for compliance could void the user's authority to operate this equipment. (Example use only shielded interface cables when connecting to computer or peripheral devices).

This equipment complies with Part 15 of the FCC Rules. Operation is subject to the following two conditions:

- (1) This device may not cause harmful interference.
- (2) This device must accept any interference received, including interference that may cause undesired operation.

Caution!

The manufacturer is not responsible for any radio or TV interference caused by unauthorized modifications to this equipment. Such modifications could void the user authority to operate the equipment.

1. Move all your channels to the desired position.
2. Select [All channels] and then [Yes] in the confirmation box.



20.4 Environmentally Friendly Disposal

Old electrical appliances must not be disposed of together with the residual waste, but have to be disposed of separately. The disposal at the communal collecting point via private persons is for free. The owner of old appliances is responsible to bring the appliances to these collecting points or to similar collection points. With this little personal effort, you contribute to recycle valuable raw materials and the treatment of toxic substances.

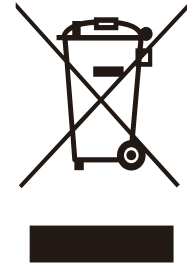

CAUTION: RISK OF EXPLOSION IF BATTERY IS REPLACED BY AN INCORRECT TYPE. DISPOSE OF USED BATTERIES ACCORDING TO THE INSTRUCTIONS.

Figures and illustrations in this manual are provided for reference only and may differ from actual product appearance. Product design and specifications may be changed without notice.



微信公众号



Bilibili



Website



Facebook



微信公众号



Bilibili



Website



Facebook



CE, FCC ID: N4ZFT1800, RCM

<http://www.flysky-cn.com>

Copyright ©2022 Flysky Technology co., Ltd.

Publication Date:2022-11-17

Manufacturer: ShenZhen FLYSKY Technology Co., Ltd.

Address: 16F, Huafeng Building, 6006 Shennan Road, Futian District, Shenzhen, Guangdong province, China