

# ANIMUS 18SC

1/18th SCALE 4x4 SHORT  
COURSE ELECTRIC TRUCK

HLNA0187

## OWNER'S MANUAL AND EXPLODED VIEW

|                |                                 |
|----------------|---------------------------------|
| LENGTH         | 275mm (10.8in)                  |
| WIDTH          | 177mm (6.9in)                   |
| HEIGHT         | 100mm (3.9in)                   |
| WHEELBASE      | 159mm (6.3in)                   |
| WHEEL DIAMETER | 30.4mm (1.2in) X 41.8mm (1.6in) |
| TIRE DIAMETER  | 59.7mm (2.4in)                  |
| WEIGHT*        | 540g (1.2lb)                    |
| BATTERY        | 1,100mAh NiMH 6-CELL, 7.2v      |
| MOTOR          | 370 SIZE @4,200 RPM             |
| RADIO          | 2.4GHz 2-CHANNEL                |
| CHARGER        | AC WALL TRICKLE                 |

\*APPROXIMATE OUT-OF-THE-BOX WEIGHT



- Entire contents ©2011 Helion RC
- Before using your product, review all documentation and inspect the products carefully. If for some reason you decide it is not what you wanted, then do not continue with unpacking, setup or operation of your product. Your local HobbyTown USA® dealer cannot accept a product for return or exchange after partaking in the afore mentioned actions
- Read and understand and follow all instructions and accompanying material carefully before operating or assembling your vehicle to prevent serious damage to your vehicle. Failure to complete these tasks properly or intentional aversion to the content will be considered abuse and/or neglect
- Product specifications are subject to change without notice. Due to ongoing development, the actual product may vary from images shown
- This product contains chemicals known to the State of California to cause cancer and birth defects or other reproductive harm
- This product is not a toy! (14+) Recommended for ages 14 and up. Adult supervision required for ages under 18 years old. Contains small parts, keep out of reach of children 3 years of age and younger



ROHS



14+



# HELION

## # PACKAGE CONTENTS...

- |                          |                              |
|--------------------------|------------------------------|
| 1. [1] ANIMUS 18SC       | 5. [1] Documentation package |
| 2. [1] Battery           | 6. [1] Antenna tube          |
| 3. [1] Radio transmitter | 7. [1] 4-Way cross wrench    |
| 4. [1] Wall charger      | 8. [1] 1.5mm L-wrench        |

## # ITEMS NEEDED TO COMPLETE...

1. [8] 1.5V AA type alkaline batteries for transmitter
  - a. To help the environment, consider replacing the disposable batteries for this transmitter and for other household electronic items with rechargeable batteries. Visit a HobbyTown USA® for hobby grade chargers and batteries
  - b. Patience while reading thoroughly through all of the instructions and guides that will help ensure you get the most out of your new Helion RC product

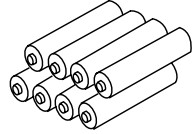

## # RECOMMENDED TOOLS (NOT INCLUDED)...

- Please use caution and follow the manufacturer's recommended operating instructions for these items and always wear eye protection

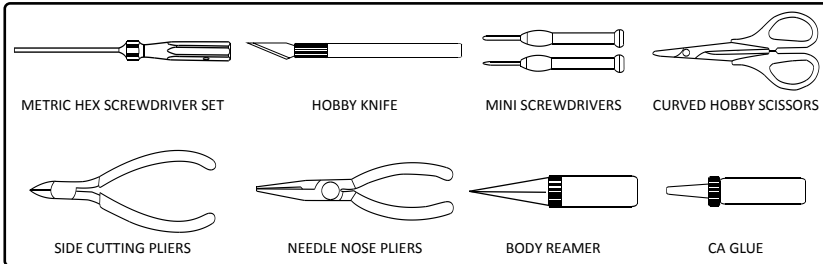

## # THE ANIMUS 18SC...

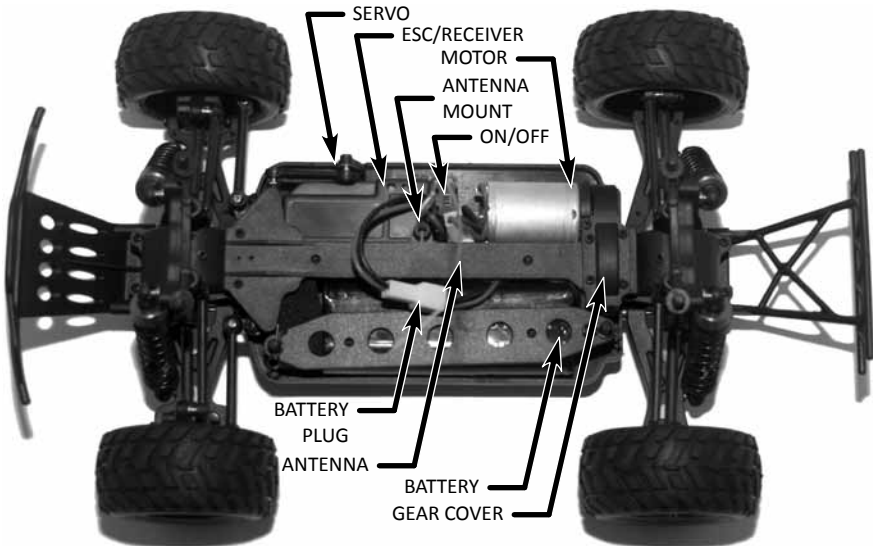

## **# GETTING STARTED...**

1. Remove the vehicle, charger and transmitter from the box and remove body
2. Remove battery from vehicle to prepare for charging
  - a. Read charging instructions and understand all warning and cautions before proceeding. ***This product is not a toy and should not be charged, operated, or maintained without supervision of an adult***
  - b. Return to this guide in the presence of the charging battery, remembering never to leave the battery unattended while charging
3. Install antenna tube by sliding antenna into tube and inserting tube into mount on chassis. Be careful not to pinch the antenna during installation. NOTE: Do NOT fold end of antenna over end of tube, this will reduce the range of the radio system and can cause interference when operating your vehicle
4. Install the [8] AA type alkaline batteries into the transmitter
5. Install the fully charged battery into the vehicle, be sure to install the pins into the lower of the two holes in the battery mounting posts
6. Ensure the motor is plugged into the ESC
7. Ensure the switch is in the OFF position and connect the battery to the ESC
8. Read and understand transmitter cautions and setting instructions before use
  - a. Confirm settings for steering and throttle trim
9. Install body with 4 supplied clips
10. Turn your equipment ON (radio first!) and enjoy!

## **# CHARGING THE BATTERY...**

- Never leave the battery unattended while charging
- Never operate the charger without adult supervision
- Never charge a warm battery, always allow the battery to cool to room temperature before charging
- Never drop the charger or battery
- Never attempt to charge a damaged battery
- Inspect the battery and charger before use. Never charge a battery or charger if the wire or connector has been damaged or if the battery has experienced a short
- Incorrect use of the battery, connections, or charging equipment can cause personal injury or property damage
- Never allow batteries or charger to come in contact with moisture at any time
- Stop charging immediately if the battery or charger becomes hot or changes form during use

**NOTE: Only use chargers designed for use with NiMH batteries for the RC industry, using the supplied connector. Use of other chargers or connectors can permanently damage the battery and/or connected equipment. Genuine NiMH replacement batteries are available at your local HobbyTown USA®.**

1. Plug the charger into a properly grounded standard US wall plug
2. Plug the battery into the charger and place the battery on/in a non-flammable surface/container and away from any flammable objects
3. A fully discharged battery should charge in approximately 4-5 hours
  - a. **Caution: Periodically monitor the temperature of the battery while charging, if the temperature exceeds 115°F (45°C), disconnect the battery from the charger and allow it to cool before reconnecting**
4. Unplug the battery from the charger when the battery is slightly warm to the touch, indicating the battery had been fully charged
  - a. Note: Using a peak detection charger is recommended and will provide you with a faster and better charging experience
  - b. **Warning: Never charge the included battery at a charge current exceeding 1.5A**
5. Remove charger from wall plug

## # UNDERSTANDING YOUR TRANSMITTER...



### **Features:**

1. Steering wheel: controls left/right motion (designed to be operated with right hand)
2. Throttle trigger: controls forward/reverse motion (designed to be operated with left index finger)
3. Handle: For holding the transmitter (designed to be held with left hand)
4. Antenna: Transmits signal to the receiver located in the vehicle
5. Control panel cover: Covers control panel housing radio setting controls
6. ON/OFF Switch: Turns the power ON/OFF for the transmitter
7. Indicator lights: Multifunction Green LED
  - a. Solid Green: Adequate battery voltage for proper operation
  - b. Flashing Green: Low battery voltage warning, batteries should be replaced/recharged before continued use
8. Bind button: Used for binding the transmitter to the receiver
9. Steering Trim: Controls the "hands-off" left/right direction of the vehicle
10. Throttle Trim: Adjusts the motor speed to STOP when trigger is in "hands-off" (neutral) position
11. Battery compartment: houses [8] AA batteries for powering the transmitter
12. Bottom cover: Closes the battery compartment, containing the AA batteries

### **Batteries:**

#### **WARNING: Do not attempt to charge non-rechargeable batteries**

- Remove the lower door from the transmitter to access the battery compartment
- Install [8] AA type batteries into the compartment
  - › Pay close attention to battery polarity (+/-) indicators during installation
- Never mix brands or old/new batteries
- Always remove dead batteries from the transmitter
- If using rechargeable batteries, be sure to follow the manufacturer's care and use instructions
- Rechargeable batteries must be removed from transmitter before charging
- Always be sure to be responsible and protect the environment when disposing batteries. Your local HobbyTown USA® dealer provides a FREE battery disposal service

## # ...TRANSMITTER CONTINUED...

### Standard operation:

- Turning the transmitter wheel to the left from center makes the wheels on the vehicle turn LEFT
- Turning the transmitter wheel to the right from center makes the wheels on the vehicle turn RIGHT
- Pulling the transmitter trigger back towards the handle will make the vehicle accelerate forward
- Pushing the transmitter trigger forward away from the handle will have the following affects depending on the location of the trigger prior to pushing it forward
  - › From a stop at neutral: the vehicle will travel in reverse
  - › From pulled back: the vehicle will apply brakes to slow the speed
    - » A second push forward of the trigger will apply reverse throttle
    - » **WARNING: Causing the vehicle to make quick transitions from forward/reverse motion to the opposite direction using the throttle control can cause damage to your vehicle and will void the warranty**

### Using your transmitter for the first time:

1. Turn the transmitter ON and ensure the LED is lit SOLID indicating the batteries are supplying adequate voltage for proper operation
2. Setting the throttle trim
  - a. If the wheels spin in a forward direction when the trigger is in the neutral position, turn down the trim until the motor stops
  - b. If the wheels spin in a reverse direction when the trigger is in the neutral position, turn up the trim until the motor stops
  - c. There will be a "dead band" area where the trim can be adjusted a slight amount in either direction and the wheels will not begin to move. It is ideal to have the trim set in the middle of this "dead band"
3. Setting the steering trim
  - a. With your vehicle and transmitter turned on (and properly responding to transmitter inputs), set the vehicle down on the ground and slowly accelerate in a direction directly away from you. If the vehicle veers slightly either to the left or right, stop the vehicle and adjust the Steering Trim knob in the opposite direction of the veer in small increments
  - b. Reset the vehicle and re-test; adjust the trim as needed until the vehicle travels in a straight line while the transmitter wheel remains at center location ("hands-off")

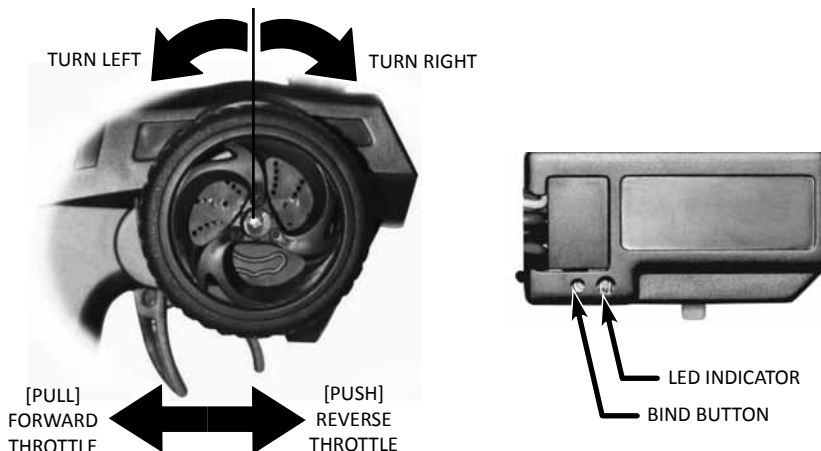

## # ...TRANSMITTER CONTINUED...

### Binding the radio system:

The process of allowing communication to occur between a 2.4GHz transmitter and receiver is called “binding” (sometimes referred to as “matching” or “pairing”). The radio system included with your product comes pre-configured and bound from the factory. In the event your system loses binding, or one of the components has been replaced, you will need to re-bind the transmitter and receiver. Follow the below steps for re-binding your radio system

1. Ensure the transmitter has good (new or charged) batteries installed and that it is powered OFF before starting
2. Connect a fully charged battery pack to the electronics module and ensure it is powered OFF before starting
3. Use a toothpick (or other small, non-metal, non-sharp object) to depress and hold the bind button on the electronics module and move the switch to the ON position
4. Release the bind button on the electronics module
5. The red LED will flash quickly on the electronics module
6. Using the toothpick (or other), depress and hold the bind button on the transmitter and move the switch to the ON position
7. Release the bind button on the transmitter
8. The green LED on the transmitter will flash slowly and the red LED on the receiver will turn off, then back on, flashing slowly
9. Move the power switches to the OFF position, first on the electronics module, then on the transmitter
10. Move the power switches to the ON position, first the transmitter, then on the electronics module
11. Ensure normal operation of throttle and steering
12. If you experience anything other than normal operation, repeat the process

## # ADJUSTMENTS AND TUNING...

The Animus 18SC has been engineered with some available tuning options listed here for reference.

**Ride height adjustment:** It is possible to adjust the ride height of your Animus 18SC by installing and/or removing adjustment clips located directly above the shock springs

- Adding more clips will raise the ride height of the vehicle and if done excessively may decrease stability.
- Removing clips will lower the ride height and may cause the chassis to drag on the ground.
- It is ideal to have the drive shafts level with the ground while the vehicle is sitting on a flat surface with the body installed. Add or remove clips to achieve the desired ride height

**Shock Position:** There are two shock installation locations for the top mounting location of the shocks. The default position is inside (located closer to the centerline of the chassis)

- Moving the shock mounting location to the outer location will result in a slightly more responsive feel on the front or rear of the vehicle
- Always check and adjust, if necessary, the ride height of your vehicle after moving the shock mounting locations

**Battery position:** It is possible to run your Animus 18SC with the battery either in a forward or rear position.

- The battery is located in the rear position from the factory. This is ideal for optimum traction and stability.
- If you desire more responsive steering and less stability, moving the battery to the forward position will provide this feeling

**Body Mount Height:** The body mounts on the Animus 18SC are capable of vertical adjustment with 4 height options available

- The default setting allows for the lowest body position while maintaining tire clearances
- Adjust the body mounts to achieve a desired look
- **Be cautions when adjusting the body lower than default locations as this will cause the tires to rub on the body and may cause damage or excessive wear to your product**

**# SAFETY TIPS...**

Although great for first time users, Helion RC products are indeed advanced radio controlled vehicles with sensitive electronics and moving parts capable of causing injury if used improperly. Always use caution and common sense as failure to operate your Helion RC product in a safe and responsible manner can result in damage to the product or other properties. Therefore this product is not intended for use or maintenance by children without direct adult supervision. Helion RC and HobbyTown USA® shall not be liable for any loss or damages, whether direct, indirect, special, incidental, or consequential, arising from the use, misuse, or abuse of this product or any product required to operate or maintain it

- Do not operate your vehicle in rain, electrical, or thunder storms
- The vehicle should never be turned ON without the transmitter being turned ON
- Never operate your vehicle when with low transmitter batteries
  - › Indicated by flashing LED on the transmitter
- Always check for proper radio system operation (steering and throttle) prior to letting go of the vehicle. If the vehicle does not respond properly to transmitter input, turn the vehicle OFF and inspect all connections and operating environment. Also see the Troubleshooting guide in this manual
- Operate in a dry (no puddles), open environment away from traffic, and cars (never run into the street for any reason)
- Always turn off both transmitter and ESC and disconnect the battery from the ESC after use
- Exercise extreme caution when touching the motor immediately after running your vehicle, it may be HOT and may cause a burn
- Always allow the motor in your vehicle to cool before using again

**NOTE: Only use genuine replacement or aftermarket parts available from your local HobbyTown USA® to ensure proper operation of your Helion RC product.**

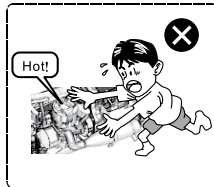
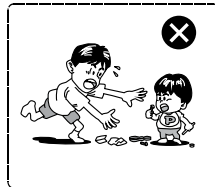
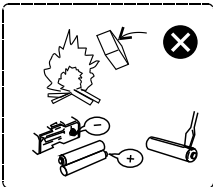
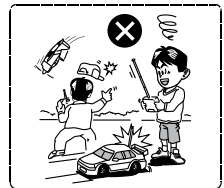
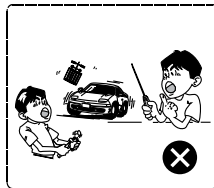
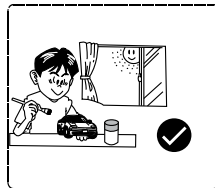

**# CARE AND MAINTENANCE...****General Care:**

- Always use clean, dry cloth or soft bristle brush to clean your equipment
- Never use chemical cleansers to avoid damage to the sensitive electronics and plastics

**Maintenance:**

We want you to enjoy your product to its fullest potential. For this to happen it is important to keep your product clean and properly maintained. Lack of cleaning and maintenance can cause component failure. For best and continued performance from your product it is recommended to briefly inspect your product for damage every few runs. Typically, a good time to do this is when changing the battery or while it is charging. If a problem is discovered, stop use immediately and seek repairs. Continued use of failed components can cause more unnecessary damage to your product. Always remember to use genuine replacement parts from your local HobbyTown USA® dealer. Below is a list of items for inspection. Inspection should not be limited to this list; if you notice any problem, listed or not, it is recommended to give it proper attention

1. Electronics: The electronics included in your vehicle are not waterproof. It is critical that they be kept away from moisture and that any moisture noticed on or around them be immediately cleaned up
  - a. Antenna: To achieve full operating range with your radio system, it is critical that the receiver antenna be installed properly and undamaged
    - i. Inspect any exposed antenna for cuts or abrasions
    - ii. Ensure there are no kinks in the antenna or antenna tube
    - iii. Never fold the end of the antenna over the tube, this will reduce the range and damage the antenna
2. Gears: Periodically remove the gear cover to inspect the gears and ensure there is no debris in the gear compartment
  - a. Proper gear mesh setting is crucial for proper operation and life of gears in your product. It is important to have the pinion gear (attached to motor) as close to the spur gear (attached to drive shaft) as possible yet while providing a minimal amount of backlash. Backlash is the rotation one gear has to make before contacting the other. Having the gear mesh set too tight will cause excess load on the electrical components and may cause premature failure. Having gear mesh set too loose will cause excess wear and possible skipping of teeth during operation thus causing excess wear and premature failure
  - b. Checking the gear mesh
    - i. Remove the spur gear cover
    - ii. Press downward on the top deck close to the spur gear to hold in place
    - iii. Check how much movement is allowed of the spur gear before the pinion gear moves (this is purely by feel, not visual)
    - iv. If the spur gear is allowed to move more than a very small amount, or if it there is no backlash, the gear mesh must be adjusted
    - v. Setting the gear mesh
      - 01). Loosen the two screws on the bottom of the chassis the hold the motor in place
      - 02). Slide motor all the way to the spur gear, so there is no backlash
      - 03). Move back slightly and hold the motor snugly in position while retightening the bottom screws
      - 04). Re-check the gear mesh and adjust again if necessary
    - vi. Re-install the spur gear cover

**WARNING: Never operate your vehicle with the spur gear cover removed. Severe injury, damage to electrical components, and excessive wear and tear on drivetrain may result.**



**# ...MAINTENANCE CONTINUED...**

3. Shocks: Periodically inspect the shocks for smooth/free motion, leaking oil and dirt residue build up around the shaft
  - a. Do not allow dirt to build up around the shock shaft and bottom of the shock. Doing so will reduce the life of the shock and cause a shock to leak oil. Be sure to clean the shocks regularly with a clean and dry soft bristle brush and/or rag
  - b. Signs to look out for determining if your shock needs to be maintained or rebuilt
    - i. Oil around the shaft means the oil leaked from inside and needs to be replaced
    - ii. Persistent oil around the shock shaft or lower portion of the shock typically points to damaged O-rings which will need replacing. See your local HobbyTown USA® for replacement parts
    - iii. Refilling your shocks:
      - 01). Remove shock from vehicle, remove spring and top cap
      - 02). With shock shaft extended, add oil to top of body (use only 100% silicone oil)
      - 03). Slowly compress the shock shaft 50% of travel using a towel or paper napkin to clean up overflowed oil
      - 04). Slowly reinstall the shock cap and check for free motion of shock
      - 05). It is normal for the shock to rebound (with the spring removed) after full compression and release
    - iv. Replacing the O-rings:
      - 01). Disassemble shock and remove shaft from the body
      - 02). Carefully remove lower cap by prying with a finger nail or similar object
      - 03). Remove the O-rings and replace with genuine replacement parts
      - 04). Re-assemble the shock following the Refilling instructions above
4. Tires and wheels:
  - a. Inspect the tires to ensure they are properly glued to the wheels. The tires on your vehicle come pre-glued from the factory; however after running your vehicle it is possible for the glue to come loose in some areas.
    - i. To reattach the tire to the wheel, use hobby grade Cyanoacrylate (CA) glue and apply small amounts (one drop at a time) between the tire and wheel. Allow the glue to fully dry before operating your vehicle

**Caution: Be sure to use extreme care when using hobby-grade CA glue. It is specially formulated to cure quickly and create a strong bond. It will bond skin and can cause injury if used improperly. Follow manufacturer's warnings and directions when using CA glue. It is always recommended to wear eye protection when maintaining your vehicle.**

- ii. When reinstalling tires, use caution when tightening the nuts that secure the wheels to the vehicle. Ensure they rotate freely but don't wobble excessively. Over tightening the wheels will cause excess strain on the electrical and mechanical components of your vehicle. Operating your vehicle under these conditions will void your warranty
    - iii. Tire wear: Consequently running your vehicle will cause the tires to eventually wear out. Be sure to obtain and use genuine replacement parts from your local HobbyTown USA® dealer
5. General wear and tear:
  - a. Use of your vehicle will cause general wear and tear which is not covered under warranty yet may necessitate replacement of components. Continued operation of your product with use of worn components may cause continued damage to other components
  - b. Be sure to regularly inspect your vehicle and accessories for excess wear and damaged components

## # STORAGE AND DISPOSAL...

### Storage:

- Always store all equipment in a cool dry place when not in use
- Always disconnect the batteries before storage
- Never store the battery, vehicle or transmitter in direct sunlight for extended periods of time
- Never store the transmitter with batteries installed for extended periods of time. Doing so may allow the batteries to leak and cause permanent damage to the transmitter

### Disposal:

Your product is equipped with NiMH batteries which are considered electronic waste and should never be discarded in standard garbage containers. Please visit your local HobbyTown USA® dealer and use the FREE battery disposal center for proper disposal/recycling

## # TROUBLESHOOTING GUIDE...

| Problem / Symptom  | Possible Cause                                   | Possible Solution  |
|--|--|--|
| Vehicle will not turn on   | Battery voltage too low                          | Charge battery   |
|  | Battery not connected                            | Re/connect battery   |
|  | Damaged battery                                  | Replace battery  |
| Transmitter will not turn on   | Battery voltage too low                          | Charge or change batteries   |
|  | Battery/ies installed improperly                 | Correct installation   |
| Short radio range (Vehicle stops responding to transmitter at short distances) | Damaged or improperly installed receiver antenna | Check receiver antenna for damage. Ensure antenna is properly installed in tube and mount, extending perpendicular from the ground |
|  | Transmitter battery voltage too low              | Replace batteries  |
| Spur gears stripping   | Gear mesh too loose                              | Tighten gear mesh for proper backlash  |
|  | Fasteners loose or missing                       | Check for loose fasteners on spur gear cover and motor mount   |
| Steering not responding as expected  | Trim not set properly                            | Adjust steering trim   |
|  | Screws too tight on steering components          | Adjust screws to allow for free motion   |
| Vehicle not responding as expected to transmitter                              | Trims not set properly                           | Adjust throttle and/or steering trim   |
|  | Radio system lost bind                           | Re-bind radio system   |
|  | Bad electrical connections                       | Check motor and battery plugs to ensure they are fully connected   |
| Vehicle top speed and acceleration is slow                                     | Battery voltage too low                          | Charge battery   |
|  | Drivetrain has too much friction                 | Check and slightly loosen wheel nuts   |
|  | Gear mesh too tight                              | Loosen gear mesh   |
|  | Pinion gear is loose                             | Check and tighten set screw on motor pinion  |
|  | Drive pin missing or stripped                    | Check for missing wheel pins (behind wheel hexes), or dogbone pins   |
| Shocks and/or arms covered in oil  | Shock O-ring seals are worn                      | Replace O-rings and refill shock with oil  |
|  | Top shock cap too loose or over tightened        | Check tightness (finger tight), refill shock oil   |
|  | Bottom shock cap dislodged                       | Check installation, refill shock oil   |

**# SPARE PARTS LIST...**

HLNA0001..... ANIMUS 18SC 4X4 SHORT COURSE ELECTRIC TRUCK.....  
HLNA0002..... MAIN CHASSIS (ANIMUS) .....  
HLNA0003..... TOP PLATE, BATTERY STRAP, FOAM & POSTS (ANIMUS) .....  
HLNA0004..... GEAR COVERS, GEAR BOXES (ANIMUS) .....  
HLNA0005..... FRONT & REAR SUSPENSION ARMS (ANIMUS) .....  
HLNA0006..... FRONT & REAR SHOCK TOWERS (ANIMUS) .....  
HLNA0007..... CASTER & STEERING BLOCKS, REAR HUBS (ANIMUS).....  
HLNA0008..... STEERING BELL CRANKS & SERVO SAVER (ANIMUS) .....  
HLNA0009..... DRIVE SHAFTS FRONT/REAR & CENTER (ANIMUS).....  
HLNA0010..... MOTOR MOUNT & INSERT (ANIMUS) .....  
HLNA0011..... CAMBER, STEERING & SERVO LINKS WITH BALL STUDS (ANIMUS).....  
HLNA0012..... FRONT & REAR SHOCK SET WITH BALL STUDS (ANIMUS) .....  
HLNA0013..... SHOCK SEALS (ANIMUS) .....  
HLNA0014..... SHOCK SPRINGS (ANIMUS).....  
HLNA0015..... HINGE PINS AND WASHERS (ANIMUS).....  
HLNA0016..... DIFFERENTIAL OUTDRIVES & AXLES (ANIMUS) .....  
HLNA0017..... DRIVE PINS, WHEEL HEXES, BODY CLIPS, ANTENNA TUBES (ANIMUS) .....  
HLNA0018..... AXLE BEARING SET (ANIMUS) .....  
HLNA0019..... GEARBOX BEARING SET (ANIMUS).....  
HLNA0020..... SPUR GEARS, 45T (ANIMUS).....  
HLNA0021..... PINION GEARS, 11T, 12T, 13T, 14T .....  
HLNA0022..... COMPLETE DIFFERENTIAL & PINION GEAR (ANIMUS) .....  
HLNA0023..... BUMPERS AND BODY MOUNTS (ANIMUS, SC) .....  
HLNA0024..... WHEELS & TIRES, LEFT & RIGHT (ANIMUS, SC) .....  
HLNA0025..... ANIMUS 18SC BODY .....  
HLNA0026..... HARDWARE & SCREWS (ANIMUS).....  
HLNA0027..... ESC, RECEIVER, SERVO (ERS) MODULE (ANIMUS) .....  
HLNA0028..... BATTERY, 7.2v 1,100mAh, NiMH .....  
HLNA0029..... MOTOR, 370 4,200 RPM .....  
HLNA0030..... WALL CHARGER, TRICKLE, MICRO PLUG .....  
HLNA0031..... ANIMUS 18SC 4X4 OWNER'S MANUAL AND EXPLODED VIEW .....  
HLNA0032..... HELION 2.4GHZ 2-CHANNEL TRANSMITTER.....

**See your local HobbyTown USA® for the latest in genuine replacement parts and accessories for your Helion RC product**

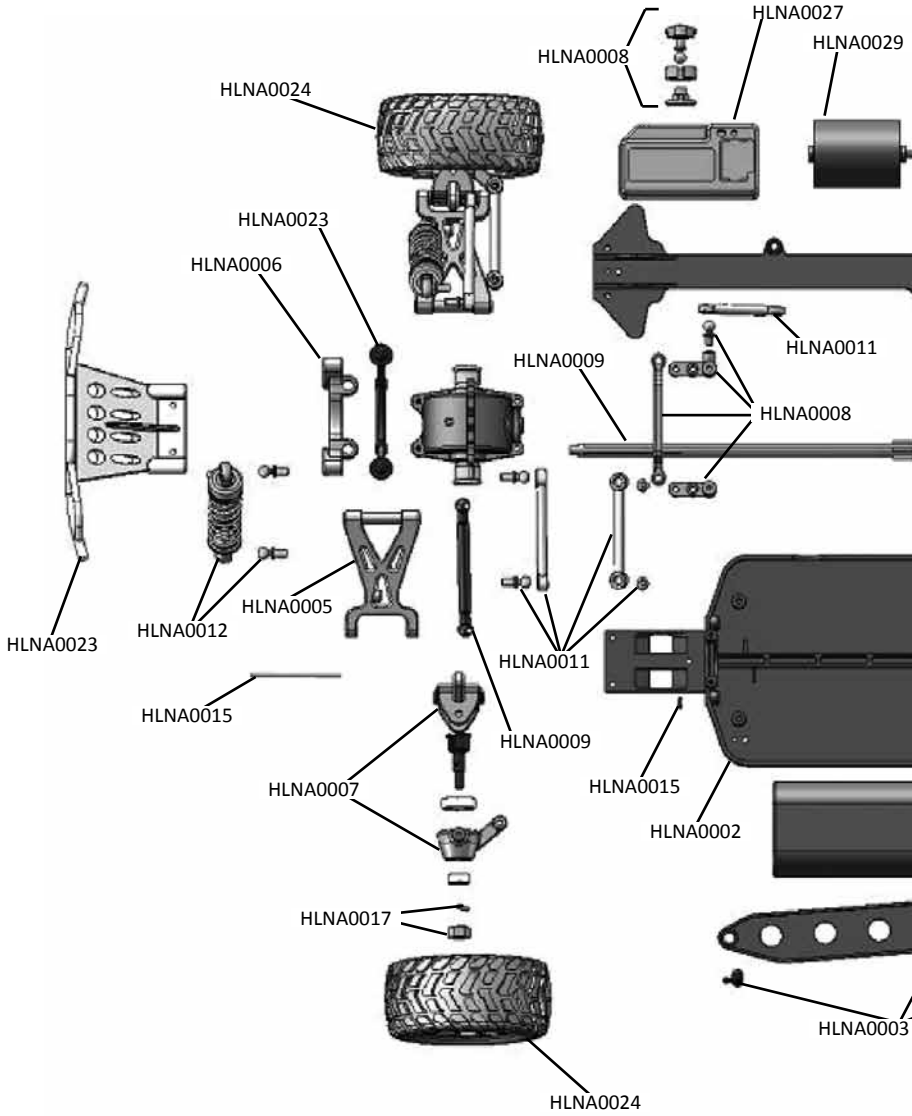

EXPLODED VIEW...

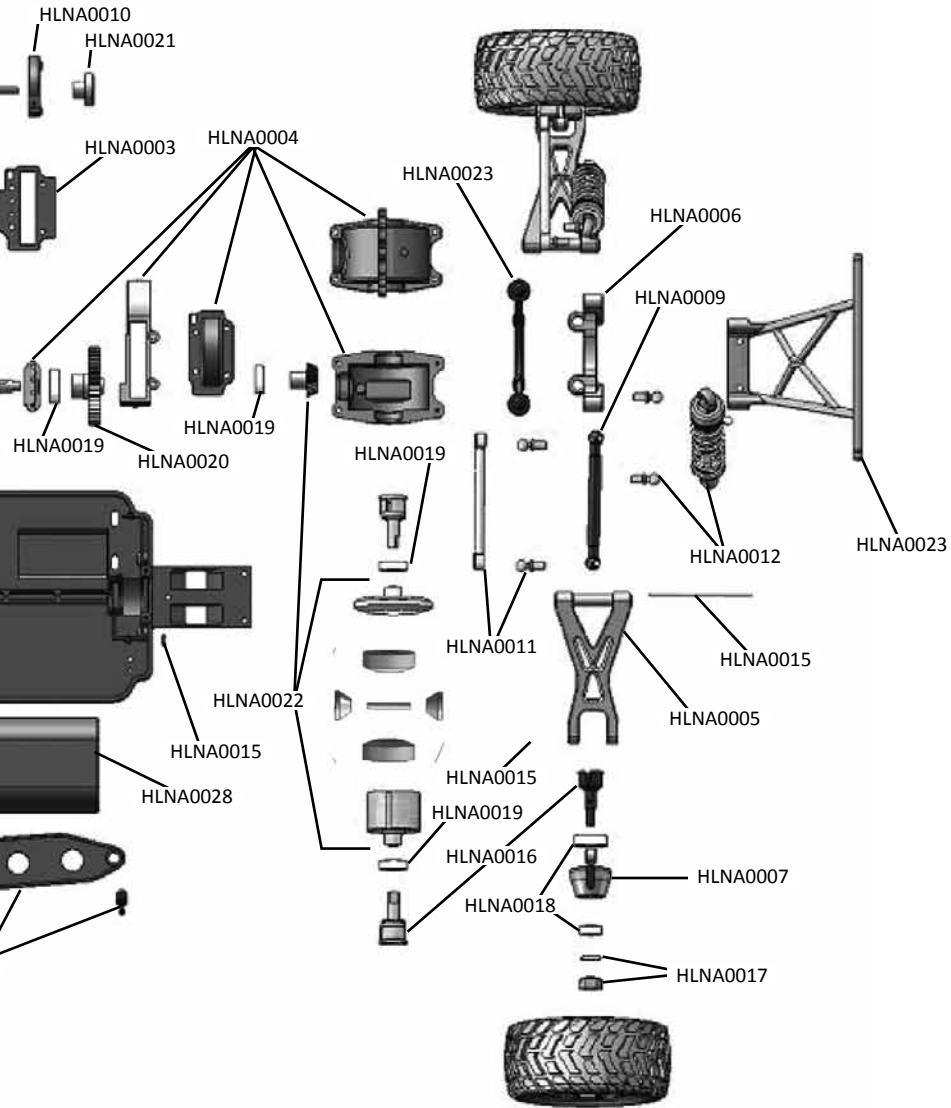

# SHOCKS EXPLODED VIEW...

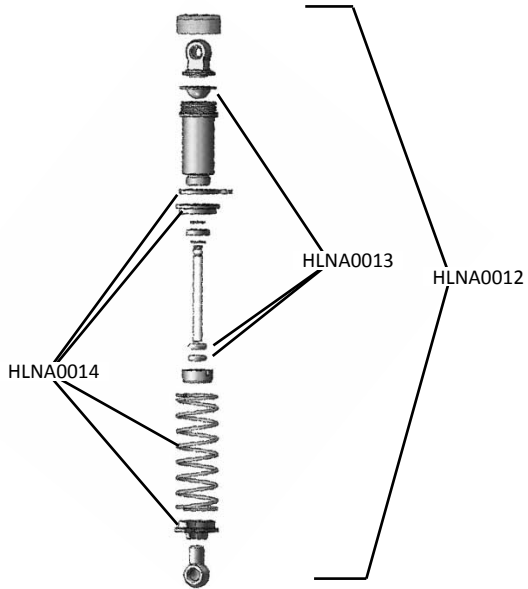

# DIFFERENTIAL EXPLODED VIEW...

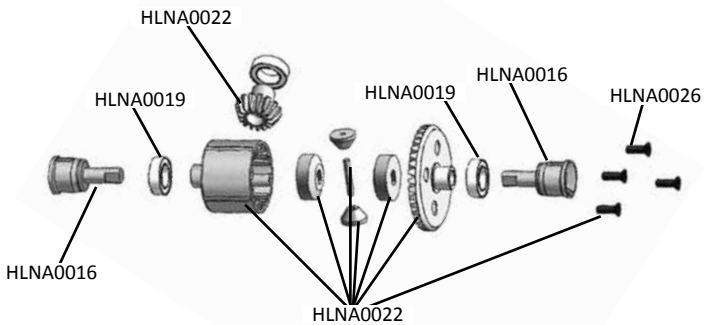

**# DECLARATION OF CONFORMITY...**

**Declaration of Conformity (DOC)**

Hereby, the manufacturer declares that this product is in compliance with the essential requirements and other relevant provisions of Directives.

The declaration of conformity may be consulted at [www.helionrc.com](http://www.helionrc.com)

**Intended Use**

The remote control is designed exclusively for private use in model construction. The remote control is not for industrial use, e.g. to control machines and equipment, determined.

Any use other than as described above, can lead to damage of the product, and beyond this, with the associated risks, such as short circuit, fire, electric shock, etc..

Contact with water must be avoided!

The remote control must not technically be changed or rebuilt!

The safety precautions are essential to follow!

You as a user are solely responsible for the safe operation of your remote control and your model!

**Disclaimer**

As compliance with the instructions, the operations and conditions when using the device at no time can be monitored by the manufacturer; the manufacturer assumes no liability for damages, costs and / or losses arising from incorrect use and / or incorrect operation or in any way connected.

**Disposal**



Electronic products are raw materials and do not belong in the trash. If the device is at the end of its useful life, dispose the device in accordance with applicable statutory regulations at the municipal collection points.

Disposing of household waste is prohibited.

**# NOTES...**

---

---

---

---

---

---

---

---

---

---

# ANIMUS 18SC

1/18th SCALE 4x4 SHORT  
COURSE ELECTRIC TRUCK



CE 0678

- ©2011 Helion RC
- Technical specifications, features and design are subject to change.
- Distribution: Robitronic Electronic GmbH +43 1 982 09 20 [www.robitronic.com](http://www.robitronic.com)

HLNA0031 [REV B]



# HELION